

CE 102: CIVIL ENGINEERING DRAWING

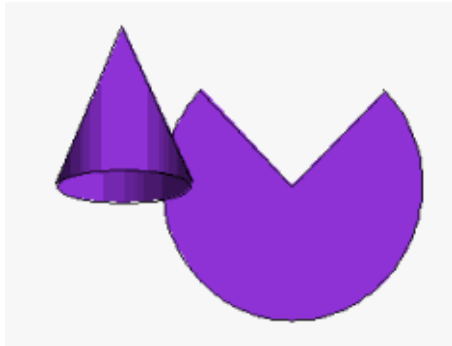

SURFACE DEVELOPMENT

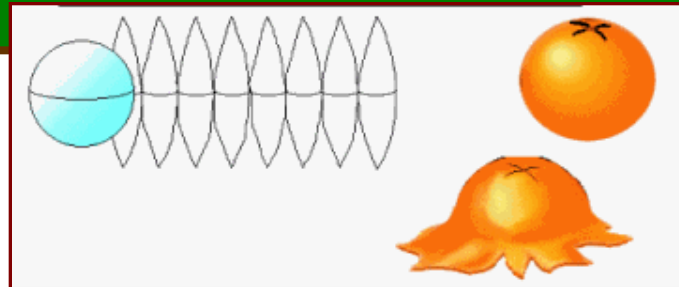

Samaha Tahseen

Lecturer, Department of Civil Engineering
University of Asia Pacific (UAP), Dhaka

CHAPTER – 4

WHAT IS SURFACE DEVELOPMENT ?

“The development of surface of an object means the unrolling and unfolding of all surfaces of the object on a plane.”

“If the surface of a solid is laid out on a plain surface, the shape thus obtained is called the development of that solid.”

In other words, the development of a solid is the shape of a plain sheet that by proper folding could be converted into the shape of the concerned solid.



IMPORTANCE OF SURFACE DEVELOPMENT



Boilers

Knowledge of development is very useful in **sheet metal work, construction of storage vessels, chemical vessels, boilers, and chimneys**. Such vessels are manufactured from plates that are cut according to these developments and then properly bend into desired shaped. The joints are then **welded or riveted**.



Chemical Vessel



Storage Vessels

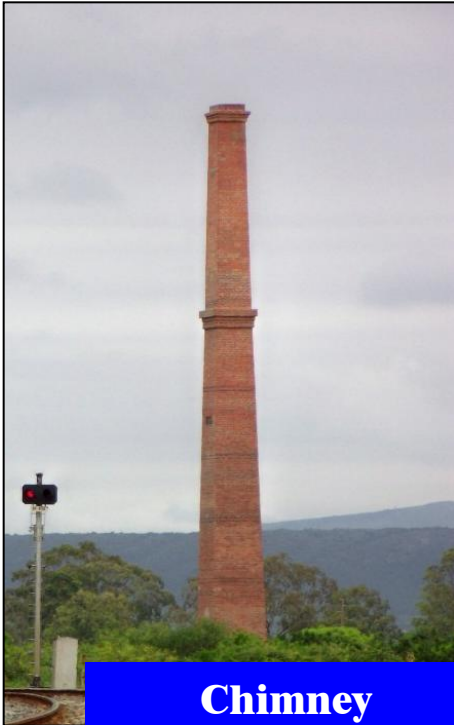

Chimney

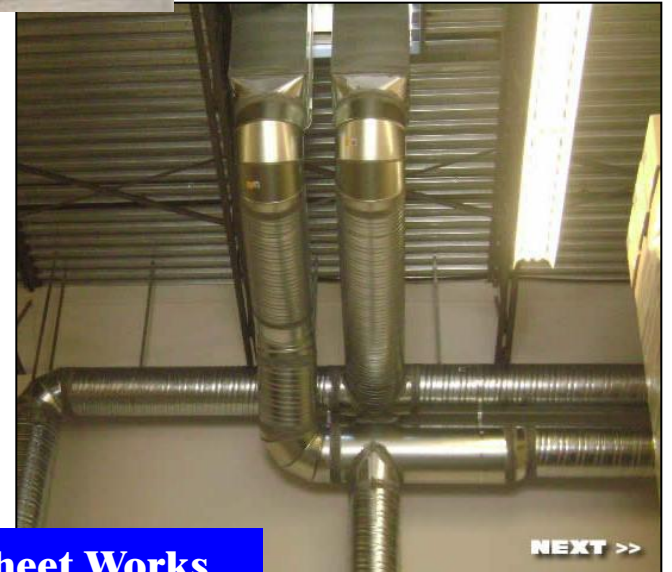

Metal Sheet Works

NEXT >>

PRINCIPLES OF SURFACE DEVELOPMENT

Every line on the development should show the true length of the corresponding line on the surface which is developed.

METHODS OF DEVELOPMENT

- Parallel-line development
- Radial-line development
- Triangulation development
- Approximate development

PARALLEL-LINE DEVELOPMENT

It is used for developing **Prisms** and single curved surfaces like **Cylinders**, in which all the edges/generation of lateral surfaces are parallel in each other.

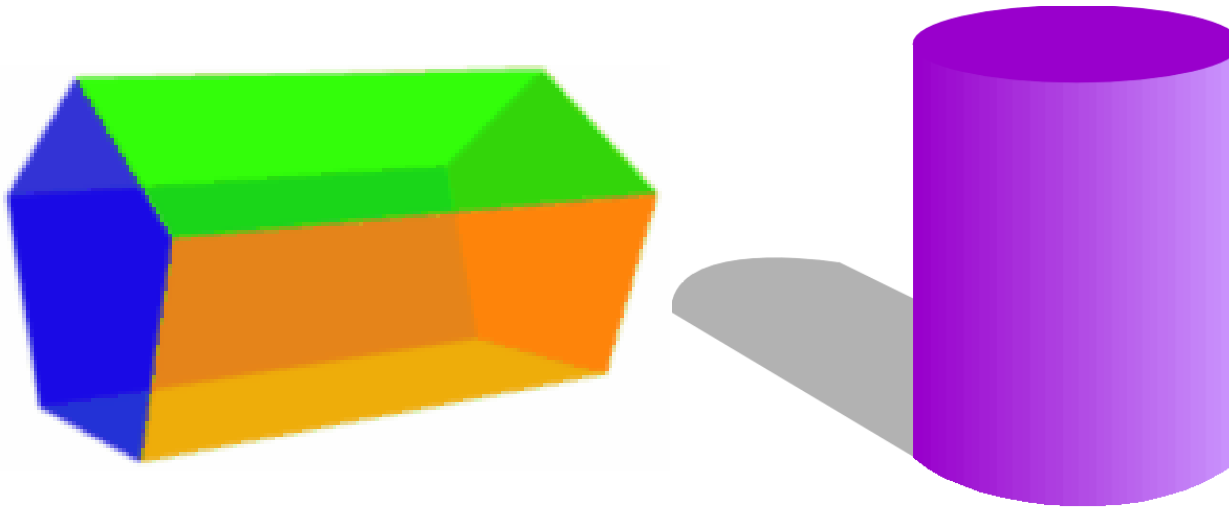

RADIAL-LINE DEVELOPMENT

It is employed for **Pyramids** and single curved surfaces like **Cones** in which the apex is taken as centre and the slant edge or generator as radius of its development.

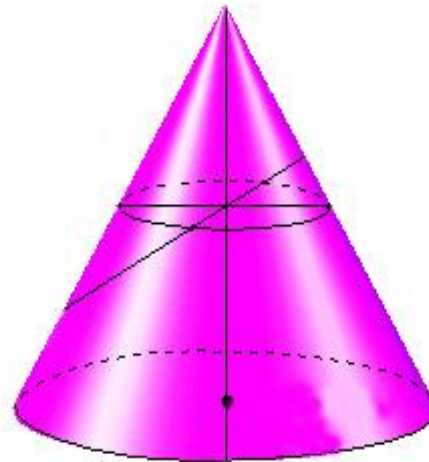

TRIANGULATION DEVELOPMENT

It is used for developing **transition pieces**.

❑ Transition pieces are usually made to connect two different forms, such as round pipes to square pipes.

❑ These transition pieces will usually fit the definition of a non developable surface that must be developed by an approximation.

❑ This is done by assuming the surface to be made from a series of triangular surfaces laid side-by-side to form the development.

❑ This form of development is known as **Triangulation**



APPROXIMATE DEVELOPMENT

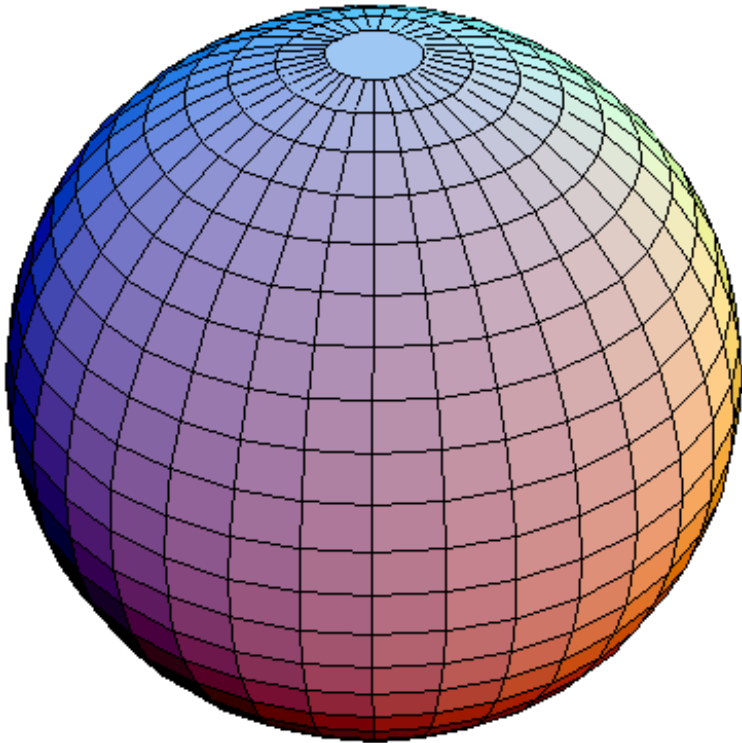

It is employed for double curved surfaces like **Spheres**, as they are theoretically not possible to develop. The surface of the sphere is developed by approximate method. When the surface is cut by a series of cutting planes, the cut surfaces is called a zone.

EXAMPLES OF PARALLEL-LINE DEVELOPMENT

Develop the surface of the cube of 1"

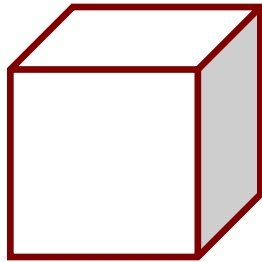

1

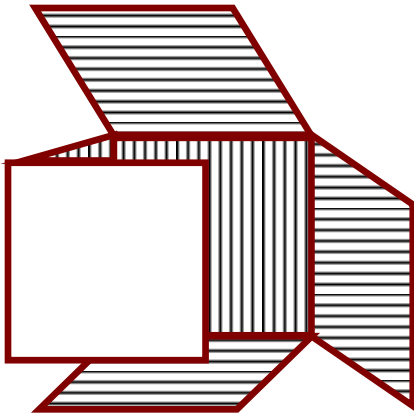
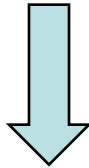

2

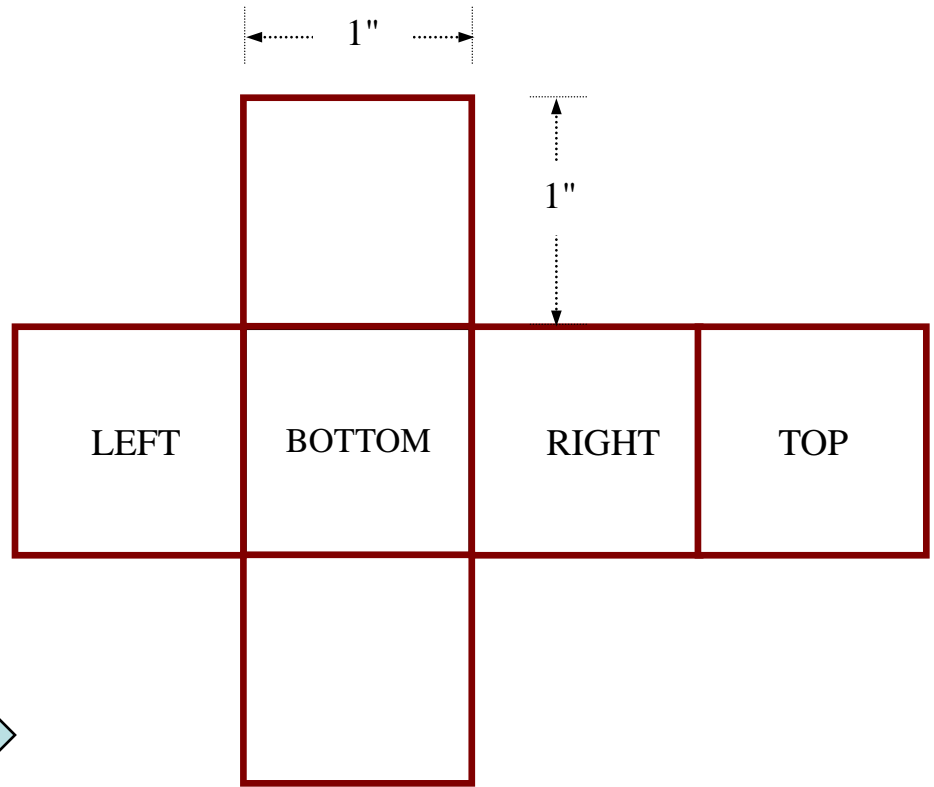

3

Develop the surface of a triangular prism

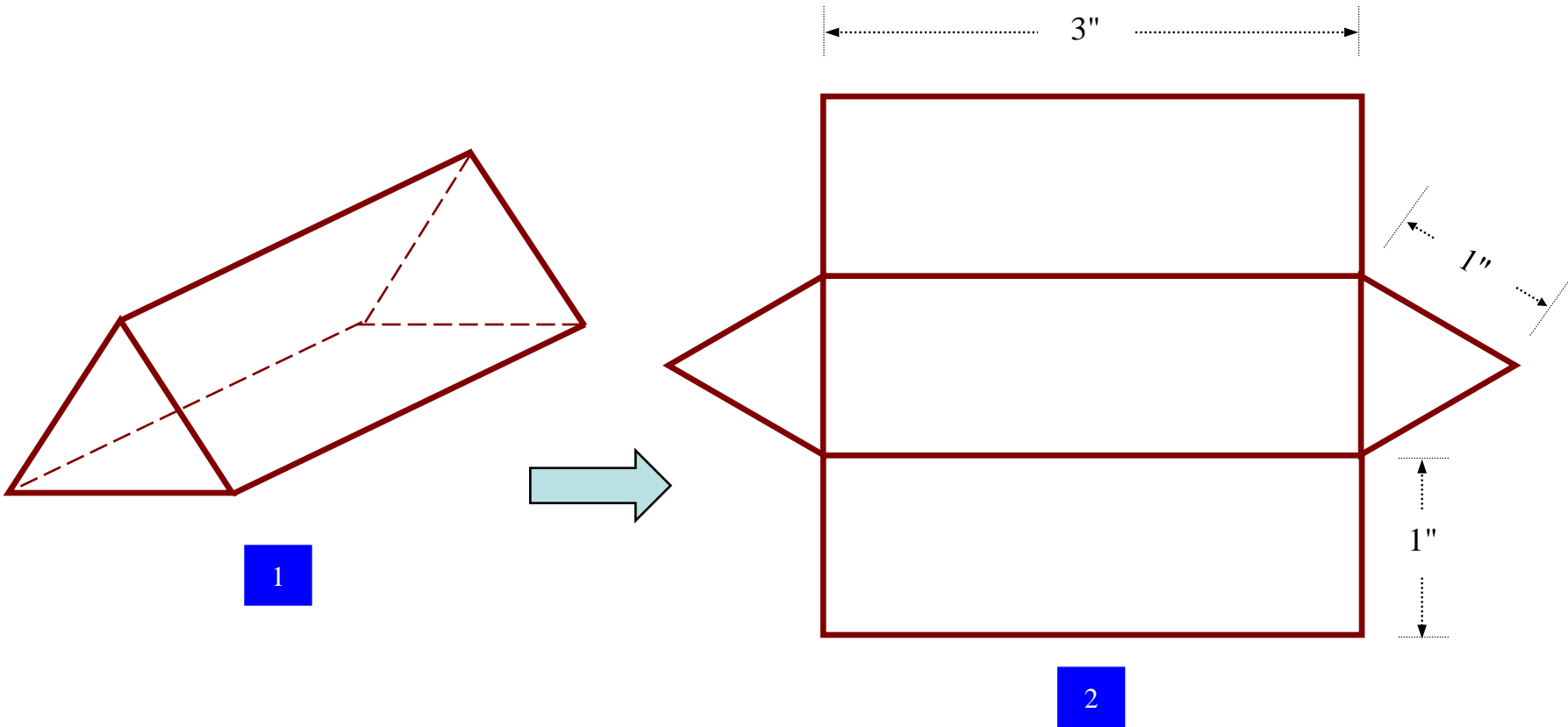

A hexagonal prism, edge of base 20 mm and axis 50 mm long, rests with its base on H.P such that one of its rectangular faces is parallel to V.P. It is cut by a plane perpendicular to V.P, inclined at 45° to H.P and passing through the right corner of the top face of the prism. Draw the sectional top view and develop the lateral surface of the truncated prism .

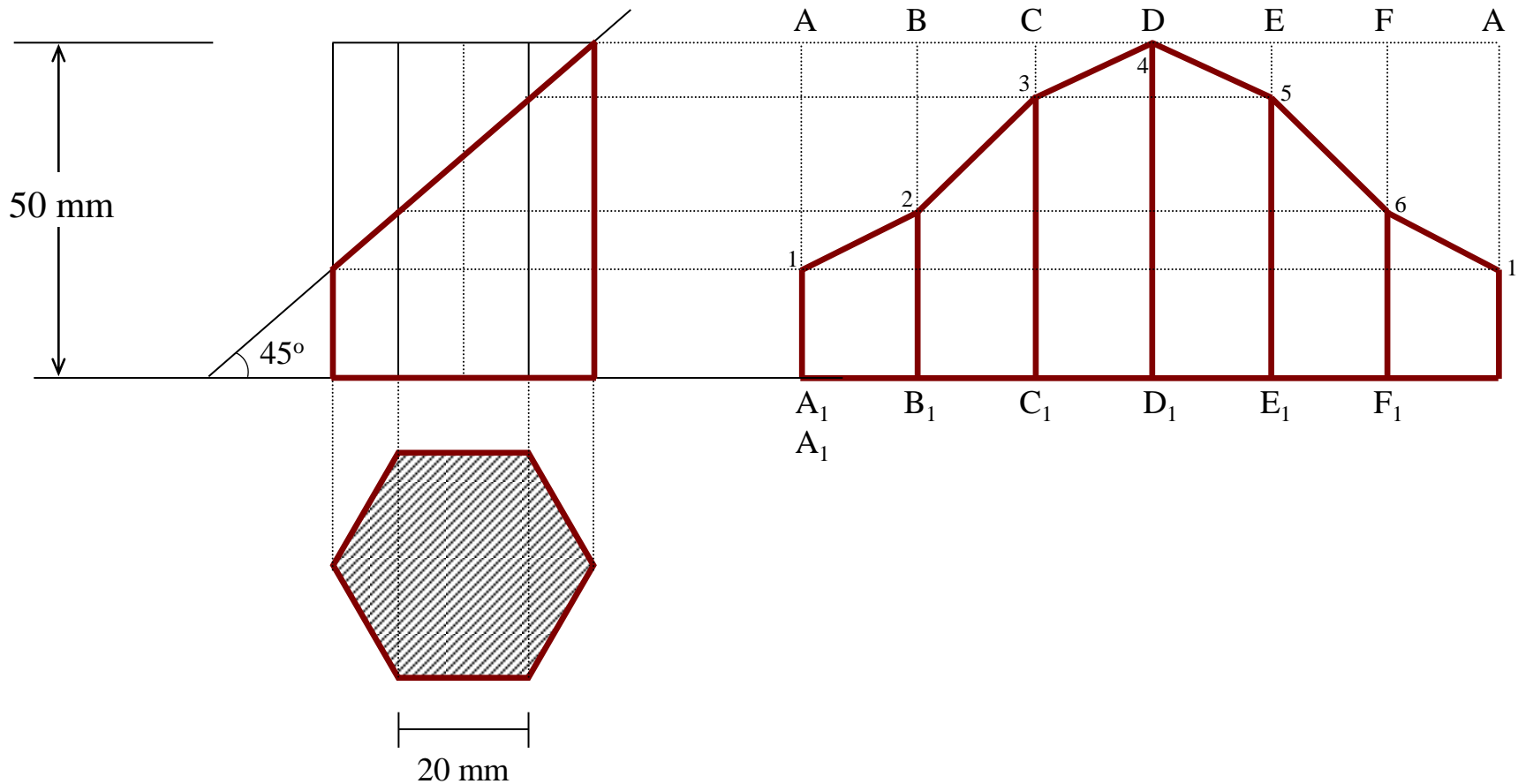

EXAMPLES OF RADIAL-LINE DEVELOPMENT

Develop the surface of a pyramid

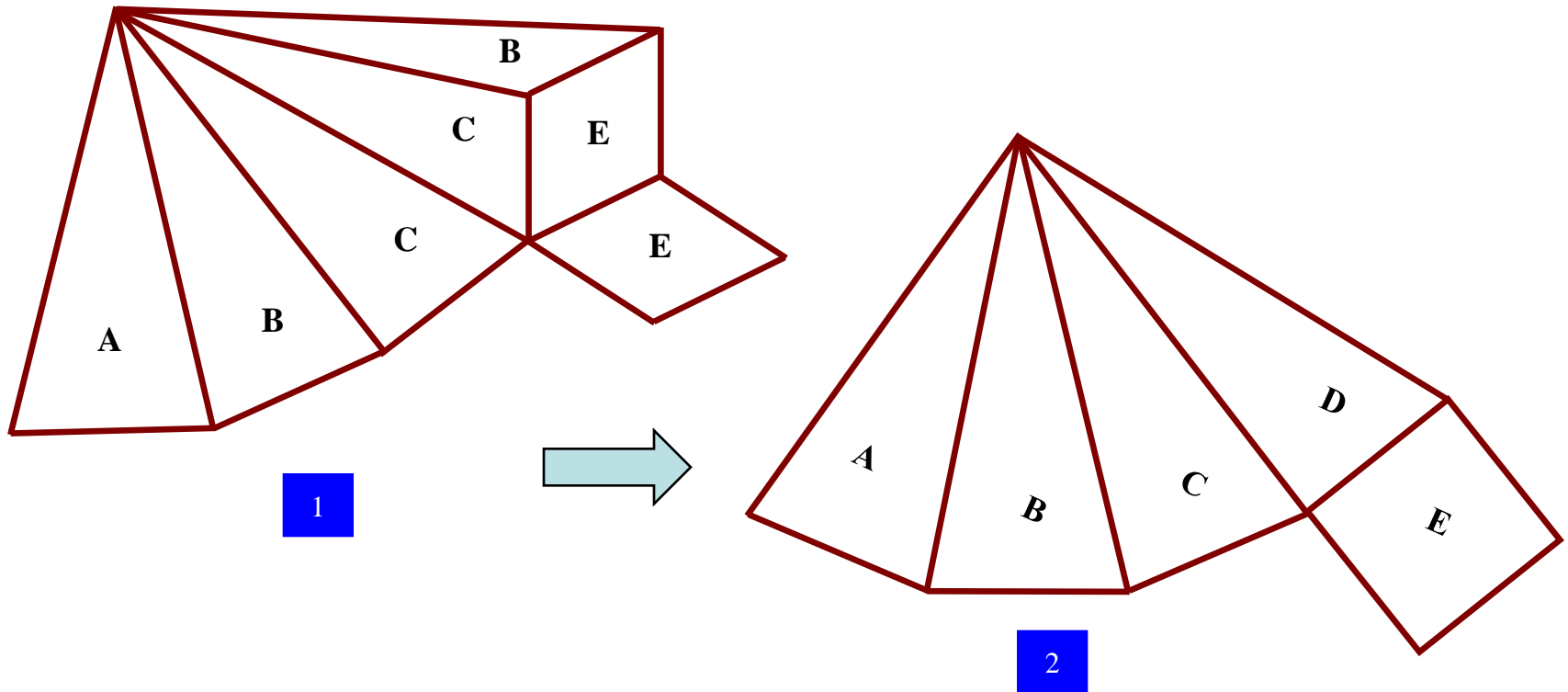

Draw the development of a cone of diameter 1.5" and inclined height 2"

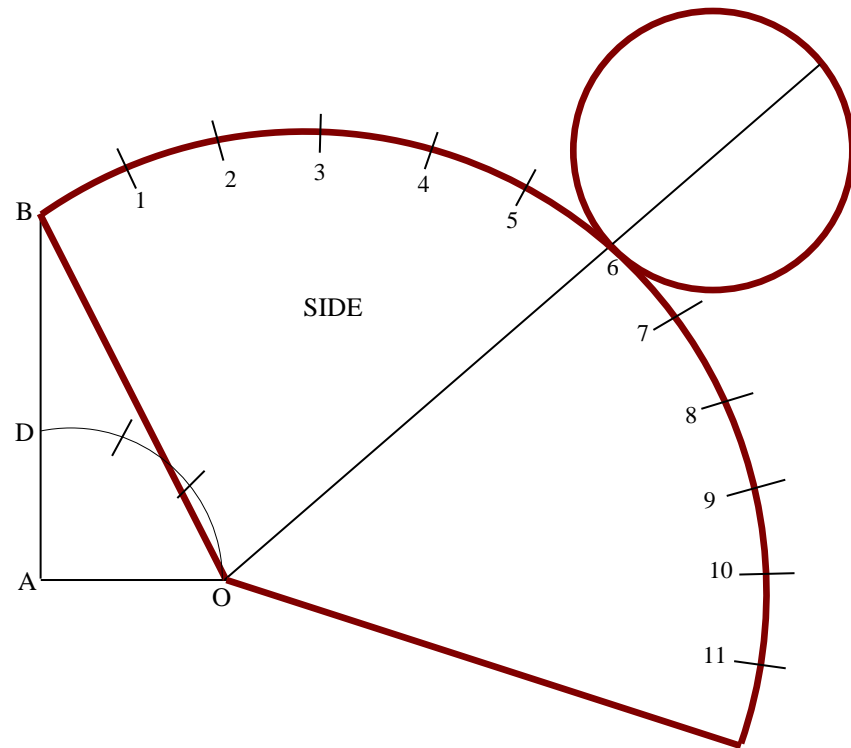
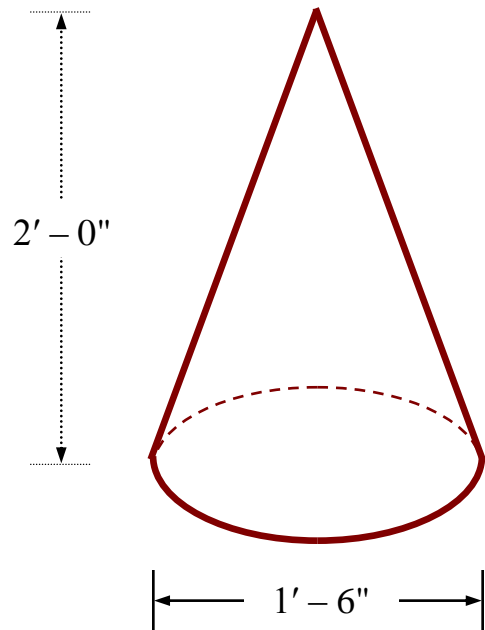

AO = Radius of the base = $\frac{3}{4}$ "
BO = Inclined height of cone = 2"

Draw the development of a square pyramid from its plan and front elevation which stands vertically on its base on H.P with one edge of the base parallel to V.P.

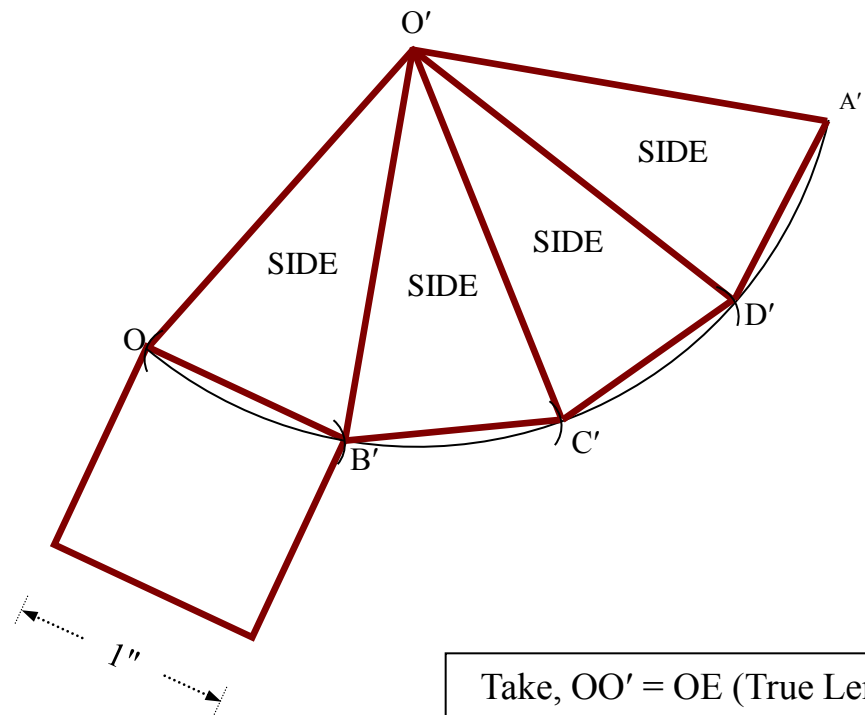
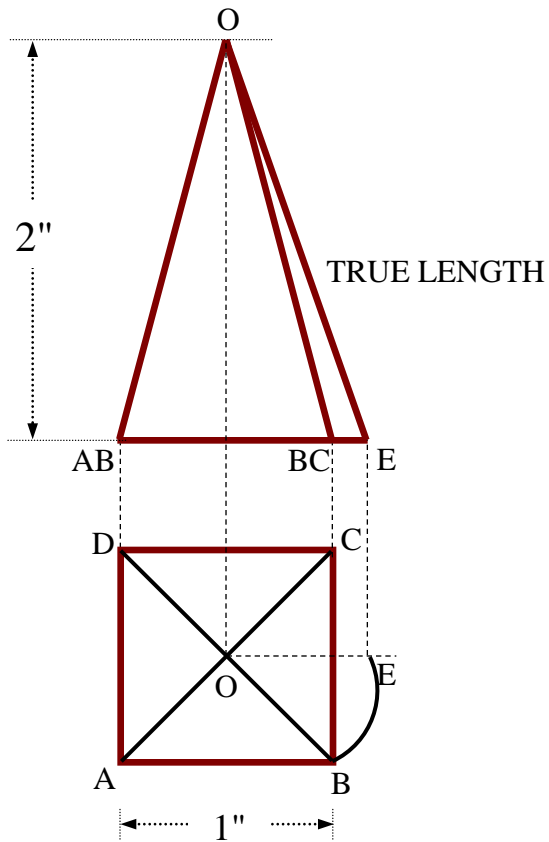

Take, $OO' = OE$ (True Length)

A cone of base 50 mm diameter and height 65 mm rests with its base on H.P. Its front elevation is cut by a plane at an angle to 30° with horizontal plane at 30 mm above base. Draw the development of the lateral surface of the truncated cone.

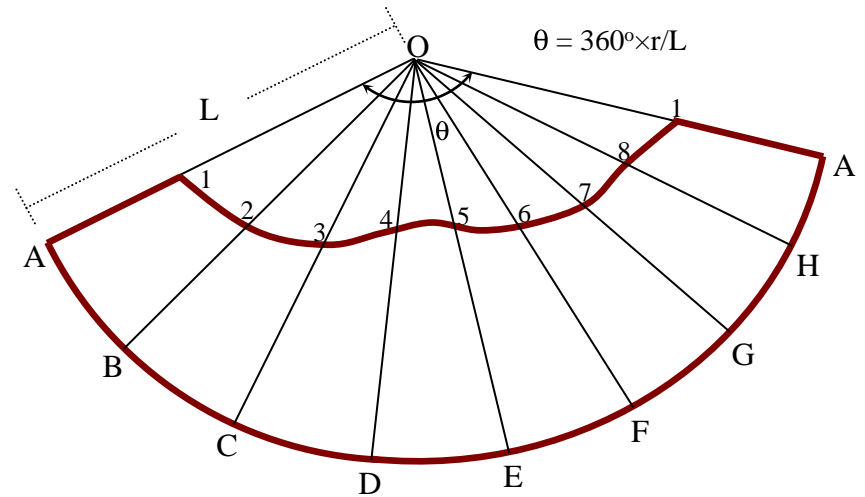
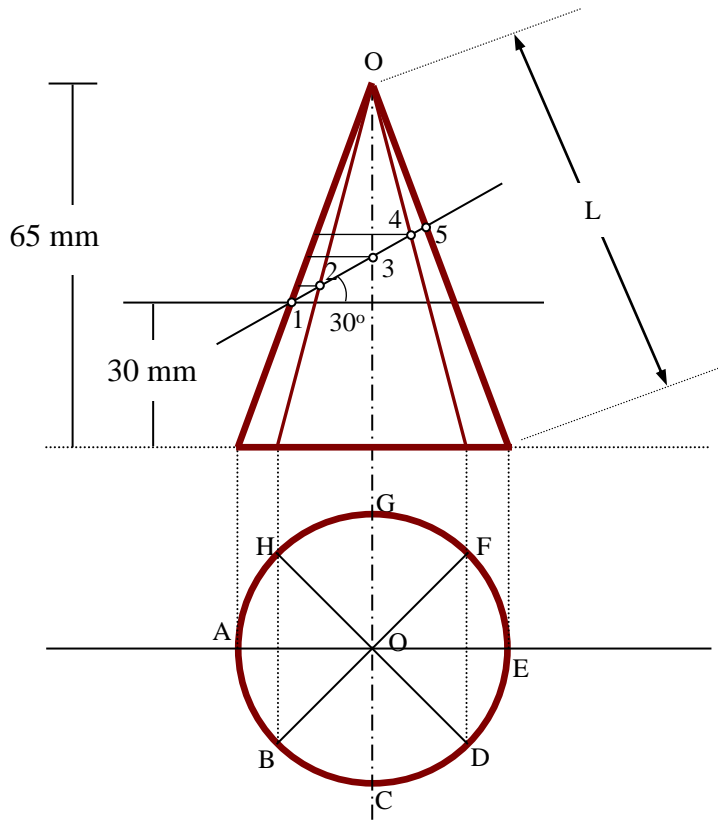

Thank You

