

Lecture Notes



Composed by

Professor Dr. Md. Shamsul Hoque
Department of Civil Engineering, BUET

February, 2015

CE451: TRANSPORTATION ENGINEERING II: PAVEMENT DESIGN AND RAILWAY ENGINEERING (4 hrs/week)

SYLLABUS:

1. Materials and Mix Design
2. Pavement Design (by Dr. Md. Shamsul Hoque)
3. Construction and Maintenance of Pavements
4. Railway Engineering

Details:

1. Introduction, materials for highway construction; aggregates: types, properties, tests, specification; binder material: production, types, tests, specs; bituminous mixes: types, design of high types mixes, Marshall, Hveem method; embankment materials, soil stabilization, cement: for rigid pavement, brick and block roads.
2. Pavement: types, definitions, history, courses, function of courses, design principles; traffic loads: characteristics, assessment; stresses in pavements: types, determination; road tests: purpose, examples: design of pavements: flexible – TAI, AASHTO, etc., rigid – PCA, AASHTO etc. joints, reinforcement.
3. Construction of embankment, subgrade, subbase, base course and low cost roads, soil- aggregate, macadam roads, equipment for constructions, Maintenance of rigid and flexible pavements.
4. Railways Engineering: General requirements, Rolling Stock & Track, Station and Yards, Points & Crossings, Signaling, Maintenance Operations.

HIGHWAY PAVEMENT

What is a Pavement?

- A multi-layer system that distributes the vehicular loads over a larger area

OR

- Highway pavement is a structure consisting of superimposed layers of selected and processed materials whose primary function is to distribute the applied vehicle load to the sub grade.

OR

- It can also be defined as "structure which separates the tires of vehicles from the under lying foundation."

- Pavement is the upper part of roadway, airport or parking area structure
- It includes all layers resting on the original ground
- It consists of all structural elements or layers, including shoulders

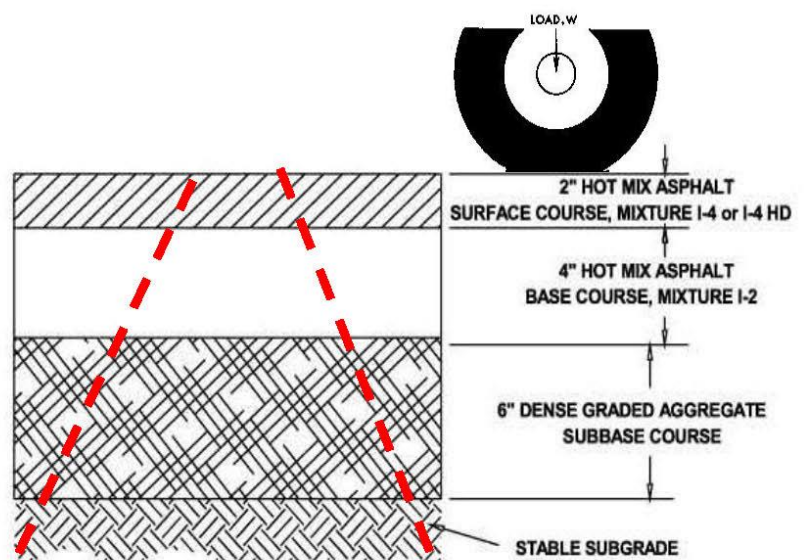

Functions and Desirable Characteristics of Pavement

Because of the heavy wheel loads of modern vehicles and the relatively low bearing capacity of subgrade soils, there must be an intermediate element between the actual load and the subgrade. For highways a pavement acts as subgrade cover, performing several functions such as :

Functions:

- Reduce and distribute the traffic loading so as not to damage the subgrade
- Provide vehicle access under all-weather conditions
- The pavement waterproofs the roadway surface by draining moisture away from the load-bearing areas and the subgrade.
- Wheel abrasion on subgrade materials is reduced or eliminated.
- It gives the driver a visual perspective of the horizontal and vertical alignment of the travel path.
- Provide safe, smooth and comfortable ride to road users without undue delays and excessive wear & tear (veh. depreciation)
- Meet environmental and aesthetics requirement
- Limited noise and air pollution

Requirements/Desirable Characteristics

- Sufficient thickness to spread loading to a pressure intensity tolerable by subgrade
- Sufficiently strong to carry imposed stress due to traffic load
- Pavement material should be impervious to penetration of surface water which could weaken subgrade and subsequently pavement
- Pavement surface should be skid resistant

Pavement History

Introduction

A brief view of how pavement design, construction and performance has evolved should help provide perspective on present and, possible, future practice. This short view into the past will start with the Romans, then move on to the Macadam and Telford era, then into the first 150 years of asphalt and portland cement concrete pavement.

Roman Roads

*Note: The terms **bitumen** (British) and **asphalt** (American) are interchangeable*

In fairness, the Carthaginians are generally credited with being the first to construct and maintain a road system (about 600 B.C.) according to Tillson [1900]. The Romans eventually decided that their neighbors across the Mediterranean were a bit of a threat to the empire destroying Carthage in 146 B.C. It is suggested that the Romans took up the practice of a military road system from the Carthaginians. It is estimated that the Romans built about 87,000 km of roads within their empire. The Roman design for their primary roads generally consisted of four layers (top to bottom) as follows [Collins and Hart, 1936]:

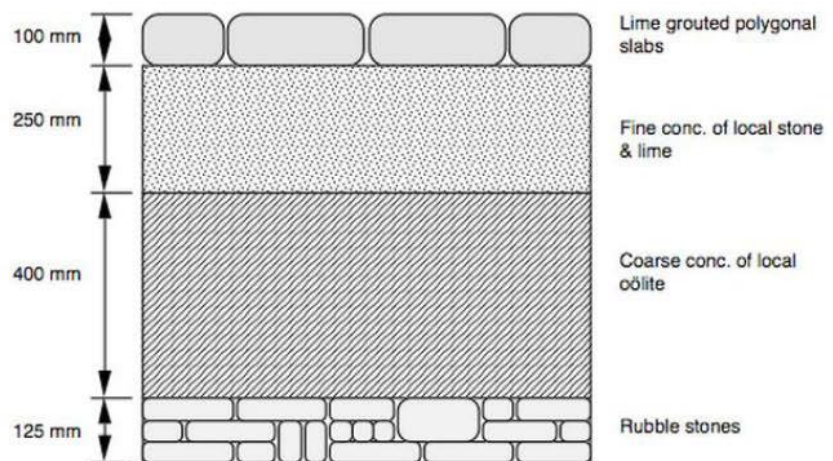

- Summa Crusta (surfacing): Smooth, polygonal blocks bedded in underlying layer.
- Nucleus: A kind of base layer composed of gravel and sand with lime cement.
- Rudus: The third layer was composed of rubble masonry and smaller stones also set in lime mortar.
- Statumen: Two or three courses of flat stones set in lime mortar.

The total thickness was as much as 0.9 m and road widths of 4.3 m or less. An illustration of Roman pavement structure near Radstock, England, is shown in the following Figure. Roman roads in some countries have been up to 2.4 m thick. These structures had crowned (sloped) surfaces to enhance drainage and often incorporated ditches and/or underground drains.

Telford and Macadam

Telford

Thomas Telford (born 1757) served his apprenticeship as a building mason [Smiles, 1904]. Because of this, he extended his masonry knowledge to bridge building. During lean times, he carved grave-stones and other ornamental work (about 1780). Eventually, Telford became the "Surveyor of Public Works" for the county of Salop [Smiles, 1904], thus turning his attention more to roads. Telford attempted, where possible, to build roads on relatively flat grades (no more than 1 in 30) in order to reduce the number of horses needed to haul cargo. Further, the pavement section was about 350 to 450 mm in depth and generally specified in three layers. The bottom layer was comprised of large stones (100 mm wide and 75 to 180 mm in depth). On top of this were placed two layers of stones of 65 mm maximum size (about 150 to 250 mm total thickness) followed by a wearing course of gravel about 40 mm thick (refer to following Figure). It was estimated that this system would support a load corresponding to 88 N/mm (500 lb per in. of width).

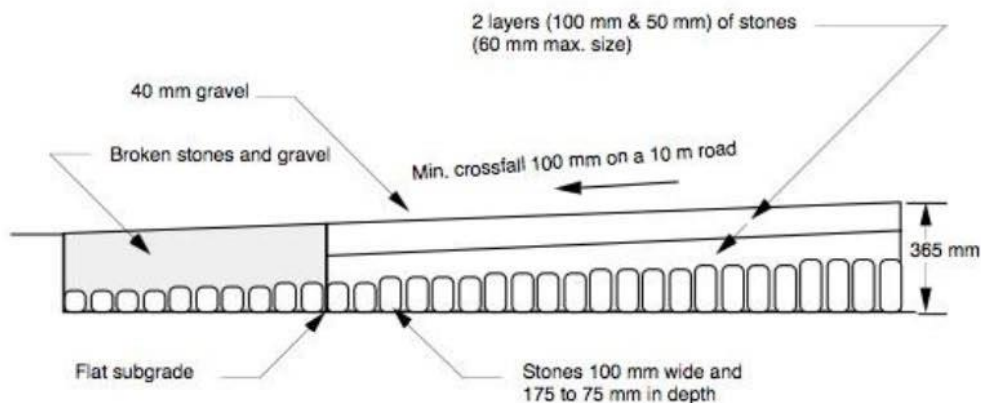

Macadam

John Macadam (born 1756) observed that most of the "paved" U.K. roads in early 1800s were composed of rounded gravel. He knew that angular aggregate over a well-compacted subgrade would perform substantially better. He used a sloped subgrade surface to improve drainage (unlike Telford who used a flat subgrade surface) on which he placed angular aggregate (hand-broken, maximum size 75 mm) in two layers for a total depth of about 200 mm. On top of this, the wearing course was placed (about 50 mm thick with a maximum aggregate size of 25 mm). Macadam's reason for the 25 mm maximum aggregate size was to provide a "smooth" ride for wagon wheels. Thus, the total depth of a typical Macadam pavement was about 250 mm (refer to the following Figure). An interesting quote attributed to Macadam about allowable maximum aggregate sizes was that "no stone larger than will enter a man's mouth should go into a road". The largest permissible load for this type of design was estimated to be 158 N/mm (900 lb per in. width).

It proved successful enough that the term "macadamized" became a term for this type of pavement design and construction. The term "macadam" is also used to indicate "broken stone" pavement. By 1850, about 2,200 km of macadam type pavements were in use in the urban areas of the UK. Macadam realized that the layers of broken stone would eventually become "bound" together by fines generated by traffic.

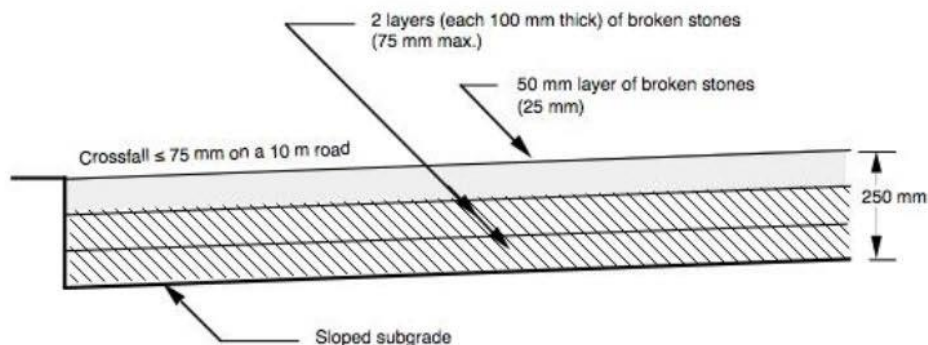

Early Thickness Trends

Thus, we have seen pavement structures decrease from about 0.9 m (3 feet) for Roman designs to 350 to 450 mm for Telford designs, to about 250 mm for Macadam designs, to 100 mm at about the turn of the century (refer to Figure 4). (Naturally, the thinnest pavements were not always used.) The Massachusetts Highway Commission standard cross-section for macadam construction was 150 mm thick as reported by Gillette in 1906. This thickness was also used on New York state roads at about that time.

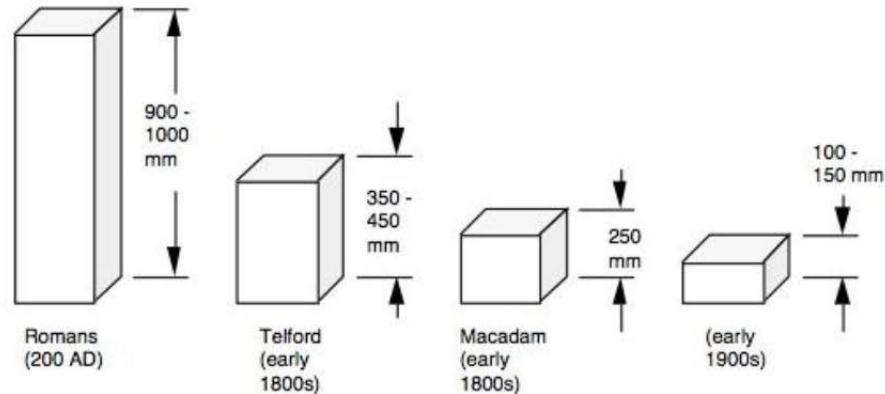

Early Portland Cement Concrete Pavements

At the turn of the century (1900), cements were categorized as "natural" or "artificial." Natural cements were made directly from specific rock. Artificial cement was made from proportioned ingredients and became known as "Portlands". Interestingly, portland cement concrete (PCC) was not used as a pavement wearing course much until after about 1910 (Agg, 1940); however, it was regularly used as a "stiff" base to support other wearing courses such as wooden blocks, bricks, cobble stones, etc.



An older Portland Cement Concrete road (USA, paved in 1919)

PCC was first used as a base for other wearing courses in London in 1872 (after Tillson, 1900) and in New York in 1888 (base for stone surfacing). According to Collins and Hart (1936), the first use of PCC as a wearing course was in Edinburgh, U.K., in 1872 and Grenoble, France, in 1876; however, one source stated that the first PCC pavement was placed in Inverness, Scotland, in 1865. The first PCC pavement in the U.S. was constructed in 1891 in Bellefontaine, Ohio. This pavement was only 3.0 m wide and 67.1 m long (probably what we would call a "test section" today). In 1909, in Wayne County, Michigan, a PCC highway system was constructed.

Pavement Types

Basically, all hard surfaced pavement types can be categorized into two groups, flexible and rigid.

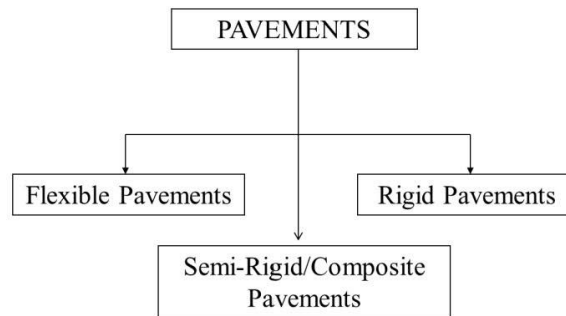

Flexible pavements are those which are surfaced with bituminous (or asphalt) materials. These can be either in the form of pavement surface treatments (such as a bituminous surface treatment (BST) generally found on lower volume roads) or, hot mix asphalt (HMA) surface courses (generally used on higher volume roads such as the Interstate highway network). HMA is known by many different names such as hot mix, asphalt concrete (AC or ACP), asphalt, blacktop or bitumen. These types of pavements are called "flexible" since the total pavement structure "bends" or "deflects" due to traffic loads. A flexible pavement structure is generally composed of several layers of materials which can accommodate this "flexing". On the other hand, rigid pavements are composed of a PCC surface course. Such pavements are substantially "stiffer" than flexible pavements due to the high modulus of elasticity of the PCC material. Further, these pavements can have reinforcing steel, which is generally used to reduce or eliminate joints.

Each of these pavement types distributes load over the subgrade in a different fashion. Rigid pavement, because of PCC's high elastic modulus (stiffness), tends to distribute the load over a relatively wide area of subgrade (see Figure 1). The concrete slab itself supplies most of a rigid pavement's structural capacity. Flexible pavement uses more flexible surface course and distributes loads over a smaller area. It relies on a combination of layers for transmitting load to the subgrade (see Figure 1).

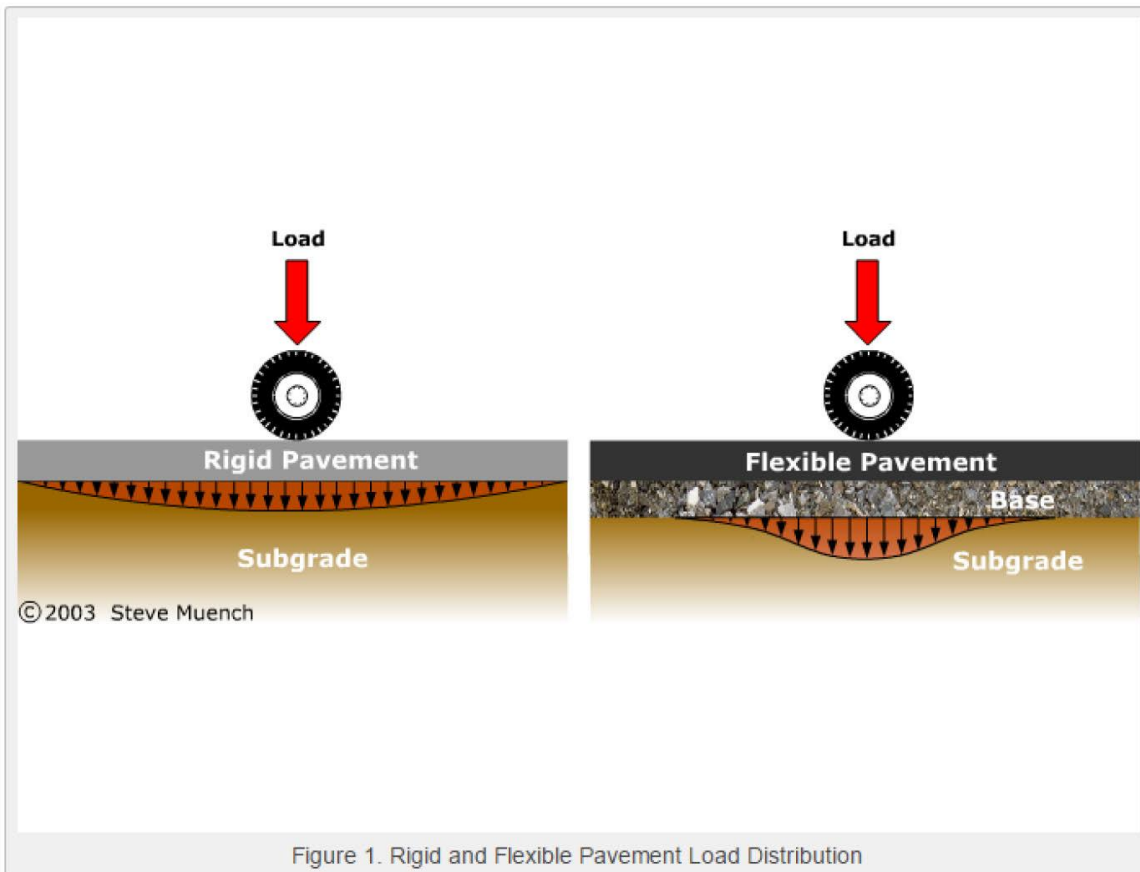

Figure 1. Rigid and Flexible Pavement Load Distribution

Flexible Pavement

- A flexible pavement is a structure that maintains intimate contact with and distributes load to the sub grade and depends on aggregate interlock, particle friction and cohesion for stability.
- Each layer receives the loads from the above layer, spreads them out, then passes on these loads to the next layer below. Thus, the further down in the pavement structure a particular layer is, the less load (in terms of force per unit area) it must carry.
- A flexible pavement is essentially a multilayered system.
- It has low flexural strength.
- The external load is largely transmitted to subgrade by the lateral distribution with increasing depth.
- The pavement deflects momentarily under load but rebounds to its original level on removal of load.
- Pavement thickness is so designed that the stresses on the subgrade soil are kept within its bearing power and the subgrade is prevented from excessive deformations.
- In a flexible pavement, the subgrade plays an important role as it carries the vehicle loads transmitted to it through the pavement.
- Strength & smoothness of the pavement surface depends to a great extent on the permanent deformation suffered by the subgrade and its resistance to such deformation.
- If the pavement itself is very strong, but it is constructed on loose and poor subgrade, it can fail.



In some applications, however, the performance of conventional bitumen may not be considered satisfactory because of the following reasons:

1. In summer season, due to high temperature, the bitumen becomes soft resulting in bleeding, rutting and segregation finally leading to failure of pavement.
2. In Winter season, due to low temperature, the bitumen becomes brittle resulting in cracking, raveling and unevenness which makes the pavement unsuitable for use.
3. In rainy season, water enters the pavement resulting into pot holes and sometimes total removal of bituminous layer.
4. In hilly areas, due to sub-zero temperature, the freeze thaw and heave cycle takes place. Due to freezing and melting of ice in bituminous voids, volume expansion and contraction occur. This leads to pavements failure.
5. The cost of bitumen has been rising continuously. In near future, there will be scarcity of bitumen and it will be impossible to procure bitumen at very high costs.

Polymer Modified Binder (PMB)

Recently, a large number investigations have demonstrated that bitumen properties (eg. viscoelasticity and temperature susceptibility) can be improved using an additive or a chemical reaction modification. The use of polymer modified bitumen's (PMBs) to achieve better asphalt pavement performance has been observed for a long time. The improved functional properties include permanent deformation, fatigue and low temperature cracking. The properties of PMVs are dependent on the polymer characteristics and content and bitumen nature, as well as the blending process. Despite the large number of polymeric products, there are relatively few types which are suitable for bitumen modification (2). The polymers that are used for bitumen modification can be divided onto two broad categories, namely plastomers and elastomers. Elastomers have a characteristically high elastic response and, therefore, resist permanent deformation by stretching and recovering their initial shape. Plastomers form a tough, rigid, three dimensional network to resist deformation. The thermoplastic rubber, styrene butadiene-styrene (SBS), is an example of an elastomer and the thermoplastic polymer, ethylene vinyl acetate (EVA), is an example of a plastomer. One of the principal plastomers used in pavement applications is the semi-crystalline copolymer, ethylene

vinyl acetate (EVA). EVA polymers have been used in road construction for more than 20 years in order to improve both the workability of the asphalt during construction and its deformation resistance in service. Figure 1 to 6 show the effect of these modifiers to bitumen before and after ageing.

Rigid pavement

Rigid pavements are those, which contain sufficient beam strength to be able to bridge over the localized sub-grade failures and areas of inadequate support.

- Single layer system.
- Derives its capacity to withstand loads from the flexural strength or beam strength.
- Inherent strength of the slab itself is called upon to play a major role in resisting the wheel load.
- Minor imperfections or localized weak spots in the material below the slab can be taken care of by the slab itself.
- As long as a certain minimum requirement is met with in this regard, the performance of the rigid pavement is more governed by the strength of the slab itself than by the subgrade support.



Rigid pavements, though costly in initial investment, are cheap in long run because of low maintenance costs. There are various merits in the use of Rigid pavements (Concrete pavements) are summarized below:

- a. Bitumen is derived from petroleum crude, which is in short supply globally and the price of which has been rising steeply. India imports nearly 70% of the petroleum crude. The demand for bitumen in the coming years is likely to grow steeply, far outstripping the availability. Hence it will be in India's interest to explore alternative binders. Cement is available in sufficient quantity in India, and its availability in the future is also assured. Thus cement concrete roads should be the obvious choice in future road programs.
- b. Besides the easy availability of cement, concrete roads have a long life and are practically maintenance-free.
- c. Another major advantage of concrete roads is the savings in fuel by commercial vehicles to an extent of 14-20%. The fuel savings themselves can support a large program of concreting.
- d. Cement concrete roads save a substantial quantity of stone aggregates and this factor must be considered when a choice of pavements is made.
- e. Concrete roads can withstand extreme weather conditions – wide ranging temperatures, heavy rainfall and water logging.
- f. Though cement concrete roads may cost slightly more than a flexible pavement initially, they are economical when whole-life-costing is considered.
- g. Reduction in the cost of concrete pavements can be brought about by developing semi-self-compacting concrete techniques and the use of closely spaced thin joints.

Semi-Rigid or Composite Pavement

Concrete pavement with good wear/tear and chemical resistances has great difficulties in maintenance and repairing, while asphalt concrete can easily be repaired but is not durable if under heavy loading and chemical impact. The semi-rigid pavement system has been developed by combining the advantages of the both pavements to perform like concrete but to be easily maintained like asphalt concrete. Semi-rigid pavement is a type of pavement structure in which a semi-rigid base layer, usually made up of cement-treated base (CTB) or cement-stabilized base (CSB), is overlaid with a top flexible layer of asphalt mixture. Because a considerable amount of fly ash or other waste materials can be used in CTB or CSB and less petroleum-based virgin asphalt binder is required, semi-rigid pavements are a type of environmentally friendly and sustainable pavement structure.

Semi-Rigid or Composite or Hybrid Pavement

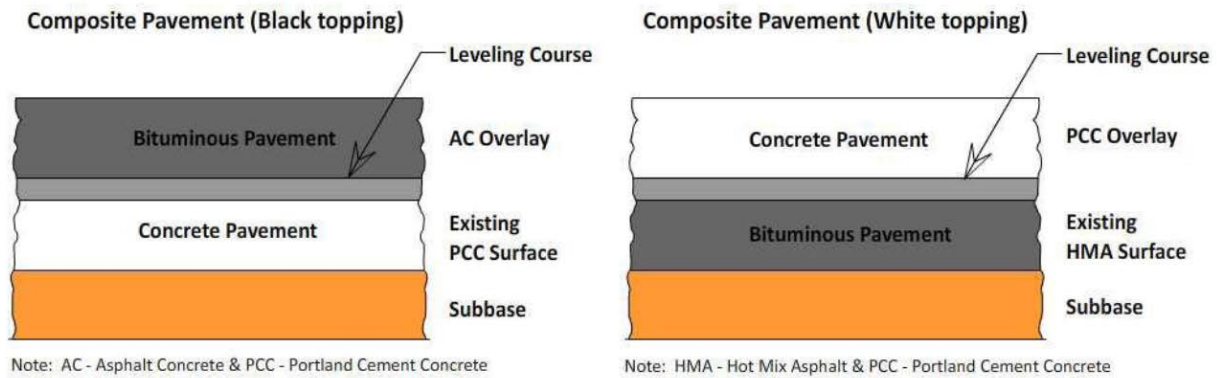

A detailed pavement classification system is shown in the following chart

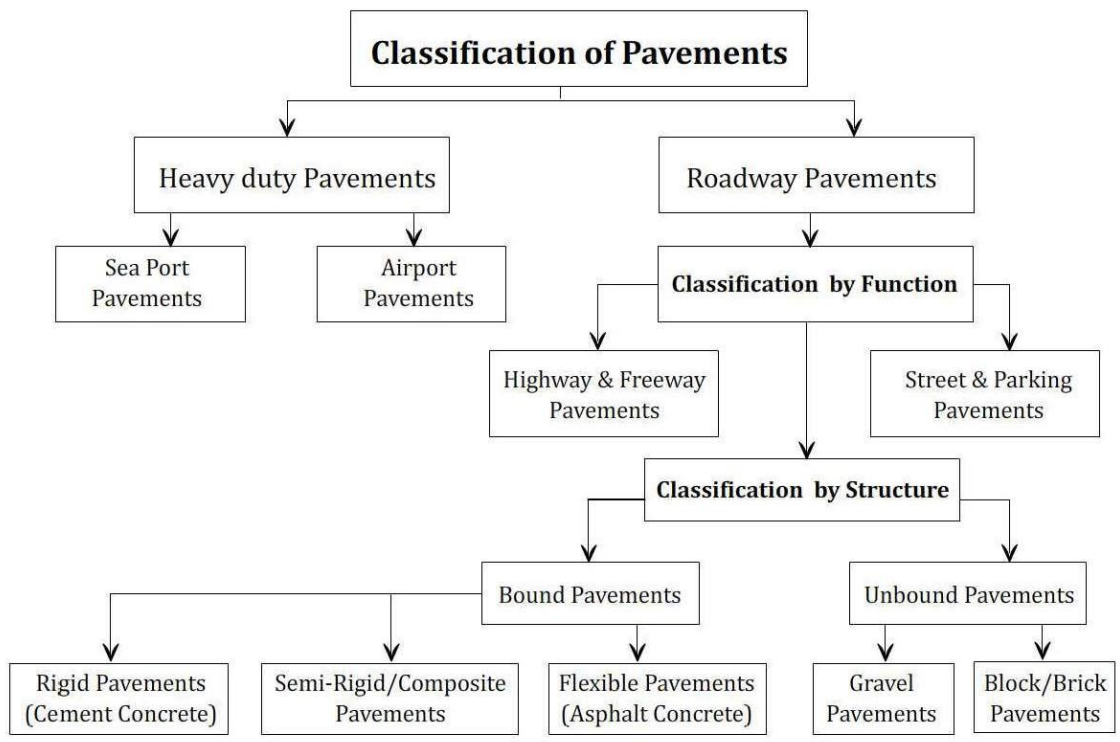

Structure of Flexible Pavement

Introduction

Flexible pavements are so named because the total pavement structure deflects, or flexes, under loading. A flexible pavement structure is typically composed of several layers of different materials. Each layer receives the loads from the above layer, spreads them out, then passes on these loads to the next layer below. Thus, the further down in the pavement structure a particular layer is, the less load (in terms of force per unit area) it must carry.

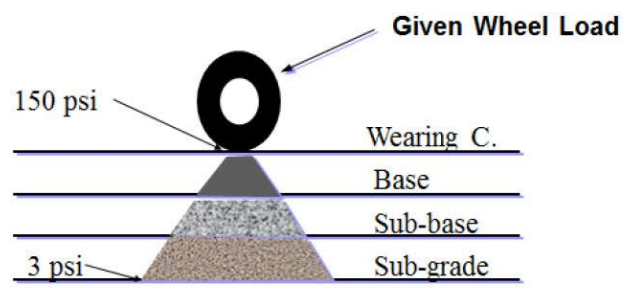

Load Distribution in Flexible Pavements

In order to take maximum advantage of this property, material layers are usually arranged in order of descending load bearing capacity with the highest load bearing capacity material (and most expensive) on the top and the lowest load bearing capacity material (and least expensive) at the bottom.

Layer System

Pavement Layer		CBR	RHD Specification Clause
Aggregate Base	Type I	$\geq 80\%$	3.3.2
	Type II	$\geq 50\%$	3.3.2
Sub-base		$\geq 25\%$	3.2.2
Improved Sub-grade		$\geq 8\%$	2.8.2
Sub-grade		$\geq 5\%$	2.7.2
Embankment fill/natural ground		$\geq 3\%$	2.6.2

Surface Course : This is the top layer and the layer that comes in contact with traffic. The surface course is the layer in contact with traffic loads and normally contains the **highest quality materials**. It provides characteristics such as friction, smoothness, noise control, rut and shoving resistance and drainage. In addition, it serves to prevent the entrance of excessive quantities of surface water into the underlying base, sub-base and sub-grade. This top structural layer of material is sometimes subdivided into two layers. This is the layer in direct contact with traffic loads. It is meant to take the brunt of traffic wear and can be removed and replaced as it becomes worn. A properly designed (and funded) preservation program should be able to identify pavement surface distress while it is still confined to the wearing course. This way, the wearing course can be rehabilitated before distress propagates into the underlying intermediate/binder course.

Binder Course : This layer provides the bulk of the HMA structure. Its main purpose is to distribute load. The base course is immediately beneath the surface course. It provides additional load distribution and contributes to drainage and frost resistance. Base courses are usually constructed out of:

- **Aggregates:** Base courses are most typically constructed from durable aggregates that will not be damaged by moisture or frost action. Aggregates can be either stabilized or un-stabilized.
- **HMA (Hot Mix Asphalt):** In certain situations where high base stiffness is desired, base courses can be constructed using a variety of HMA mixes. In relation to surface course HMA mixes, base course mixes usually contain larger maximum aggregate sizes, are more open graded and are subject to more lenient specifications.

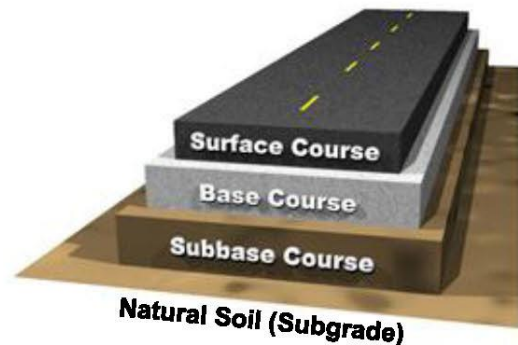

Base Course : This is the layer directly below the surface course and generally consists of aggregates (either stabilized or un-stabilized).

Sub-base Course: This is the layer (or layers) under the base layer. A sub-base is not always needed. The sub-base course is between the base course and the sub-grade. It functions primarily as structural support but it can also:

- Minimize the intrusion of fines from the sub-grade into the pavement structure.
- Improves drainage.
- Minimize frost action damage.
- Provides a working platform for construction.
- The sub-base generally consists of lower quality materials than the base course but better than the sub-grade soils.
- A sub-base course is not always needed or used.
- For example, a pavement constructed over a high quality, stiff sub-grade may not need the additional features offered by a sub-base course so it may be omitted from design.
- However, a pavement constructed over a low quality soil such as a swelling clay may require the additional load distribution characteristic that a sub-base course can offer. In this scenario the sub-base course may consist of high quality fill used to replace poor quality sub-grade.

Sub-grade Course: The "sub-grade" is the material upon which the pavement structure is placed. Although there is a tendency to look at pavement performance in terms of pavement structure and mix design alone. The sub-grade can often be the overriding factor in pavement performance. Although a pavement's wearing course is most prominent, the success or failure of a pavement is more often than not dependent upon the underlying sub-grade, the material upon which the pavement structure is built.

Sub-grades be composed of a wide range of materials although some are much better than others. This subsection discusses a few of the aspects of sub-grade materials that make them either desirable or undesirable and the typical tests used to characterize sub-grades.

Types of Flexible or Hot Mix Asphalt (HMA) Pavement

Dense-graded: A dense-graded mix is a well-graded HMA intended for general use. When properly designed and constructed, a dense-graded mix is relatively impermeable. Suitable for all pavement layers and for all traffic conditions. Works well for structural, friction, leveling and patching needs.

Open-Graded: Unlike dense-graded mixes and SMA, an open-graded HMA mixture is designed to be water permeable. Open-graded mixes use only crushed stone (or gravel) and a small percentage of manufactured sands. SMA is almost exclusively used for surface courses on high volume. It is used only as a drainage layer under dense-graded HMA, SMA or portland cement concrete.

Gap-graded or SMA: Stone matrix asphalt (SMA), sometimes called stone mastic asphalt, is a gap-graded HMA originally developed in Europe to maximize rutting resistance and durability. The mix design goal is to create stone-on-stone contact within the mixture. Since aggregates do not deform as much as asphalt binder under load, this stone-on-stone contact greatly reduces rutting. SMA is generally more expensive than a typical dense-graded HMA because it requires more durable aggregates, higher asphalt content, modified asphalt binder and fibers.

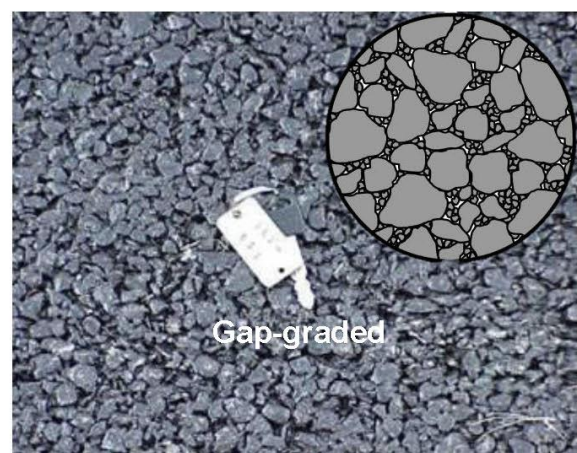
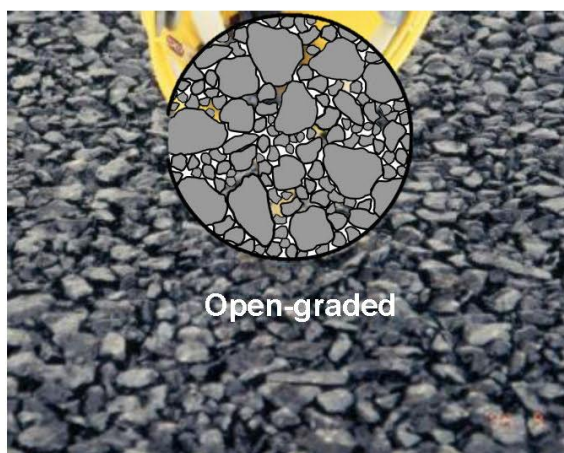

Partial Depth Pavement



Full Depth Pavement



Note: Full-depth asphalt pavements contain asphaltic cement in all components above the prepared subgrade.

Rigid Pavement

A rigid pavement structure is composed of a hydraulic cement concrete surface course, and underlying base and subbase courses (if used). Another term commonly used is *Portland cement concrete (PCC)* pavement, although with today's pozzolanic additives, cements may no longer be technically classified as "Portland."

The surface course (concrete slab) is the stiffest and provides the majority of strength. The base or subbase layers are orders of magnitude less stiff than the PCC surface but still make important contributions to pavement drainage, frost protection and provide a working platform for construction equipment.

Rigid pavements are substantially 'stiffer' than flexible pavements due to the high modulus of elasticity of the PCC material resulting in very low deflections under loading. The rigid pavements can be analyzed by the plate theory. *Rigid pavements can have reinforcing steel, which is generally used to handle thermal stresses to reduce or eliminate joints and maintain tight crack widths.*

- Rigid pavements are those, **which reduces the stress concentration and distributes the reduced stresses uniformly to the area under the slab.**
- Single layer system.
- Derives its capacity to withstand loads from the flexural strength or beam strength.
- Inherent strength of the slab itself is called upon to play a major role in resisting the wheel load.
- Minor imperfections or localized weak spots in the material below the slab can be taken care of by the slab itself.
- As long as a certain minimum requirement is met with in this regard, the performance of the rigid pavement is more governed by the strength of the slab itself than by the subgrade support.

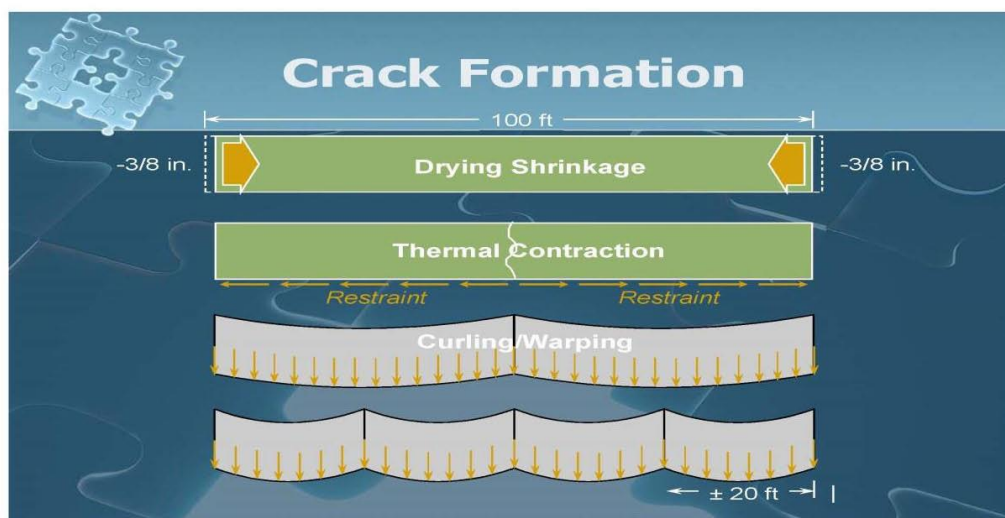
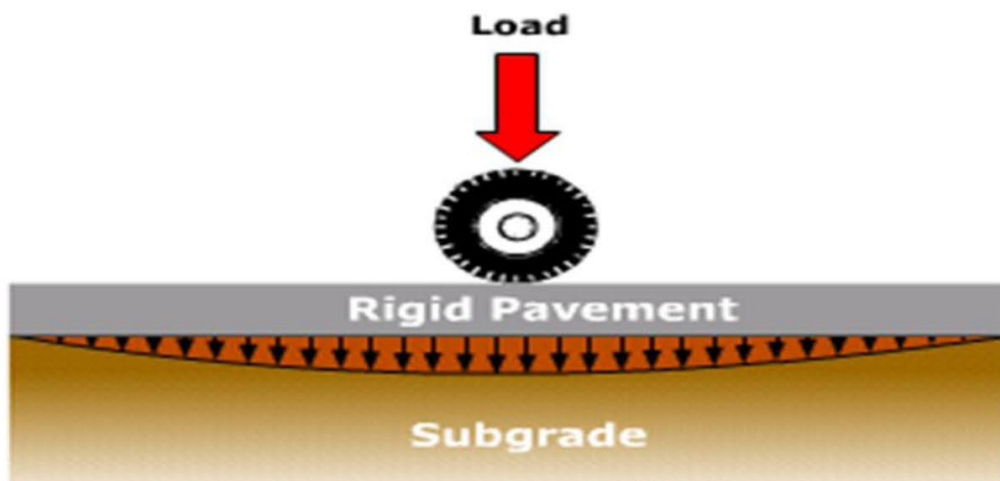

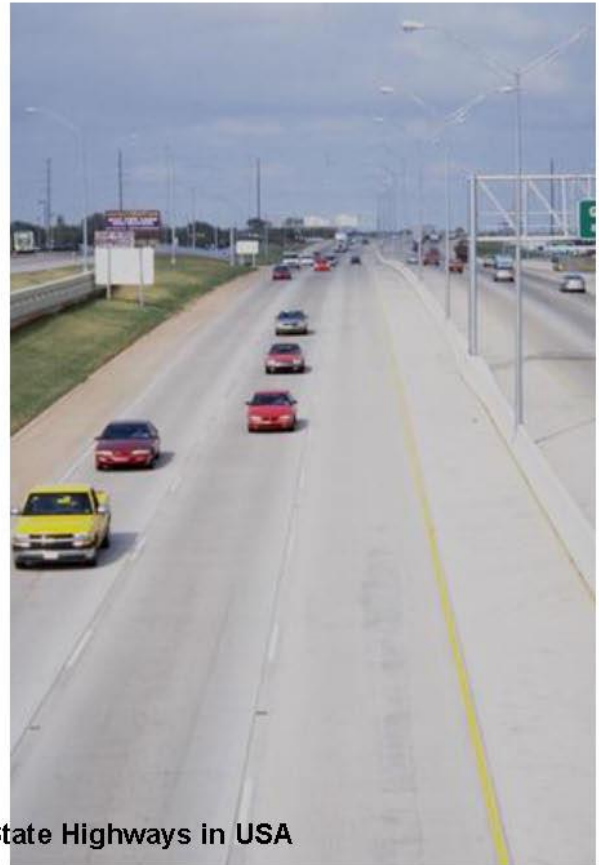

Rigid Pavement Inter-State Highways in USA



Rigid Pavement Expressway in India

Copyright © 2001 - Amit Kulkarni



Joints and Jointing Arrangements

Introduction

Properly designed pavement joints:

1. Control cracking due to aircraft loads and restrained curling and warping stresses.
2. Afford adequate load transfer across the joints.
3. Limit infiltration of foreign material into the joints.

Joints also divide the pavement into suitable increments for construction and accommodate pavement movements at intersections with other pavements or structures. To satisfy the basic pavement design assumptions, joints must provide adequate transfer of loads from one panel to the next. Load transfer is obtained by using mechanical load transfer (dowels) or by aggregate interlock. A cement-treated subbase (CTB) also will provide substantial joint support. Increasing the thickness of a pavement along certain joints is an alternative means of reducing slab bending stresses and edge deflections, allowing for adequate joint performance.

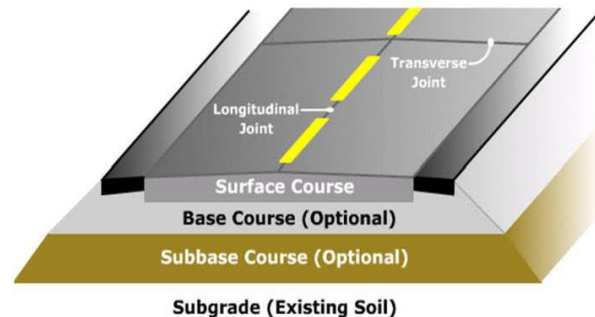

Joint Types

A. Direction-wise

- Longitudinal joints
- Transverse joints

B. Function-wise

- Contraction Joints

- are used to prevent irregular shrinkage cracks
- are used to make sure that cracking will occur at a predetermined desired locations
- are used to relieve tensile stress resulting from contraction and warping of the concrete
- constructed by cutting a groove at the pavement surface; groove may be formed by sawing or by placing a metal strip
- Load transfer usually is accomplished by aggregate interlock. However, dowel bars may be used to transfer load across the joints
- to permit freedom of movement dowel should be lubricated plain bars

- Expansion Joints

- are used to permit thermal expansion of slab and to prevent blowup at the slab edges
- are used to relieve compressive stress resulting from expansion of the concrete
- constructed with a clean break throughout the depth of the slab
- usually joint opening of 19mm (3/4") to 25mm (1") is used
- dowel bars are used to transfer load across the joints
- to permit freedom of movement, dowel bars must be smooth and lubricated on at least one side
- an expansion cap must also be provided to allow space for dowel bar to move during the expansion process
- filler (cork/plastic/rubber) and sealant materials are needed to concealed the joints to reduce infiltration of water or pumping effect and to reduce clogging of joint with hard material or chance of blowup problem
- expansion joints are susceptible to pumping action
- periodic maintenance is required

- Construction Joints

- are used at the transition from old to new construction, such as at the end of a day's pour or at longitudinal joints
- Load transfer at construction joints is achieved through the use of dowel bars
- deformed or hooked tie bars are used to hold/anchored two adjacent segments firmly to prevent movement

Contraction:

Deformed Tie Bar: 5/8 in. dia., 30 in. long
(16 mm dia., 760 mm long)

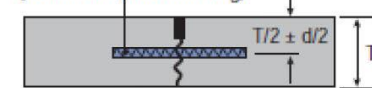

Use only on pavement 9 in. (225 mm)

Type B – Tied or Hinged

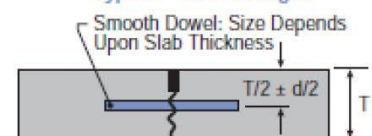

Type C – Doweled



Type D – Undoweled or Dummy

Note: Use an initial sawcut depth of T/4 on unstabilized (granular) subbases and T/3 on stabilized subbases.

Expansion:

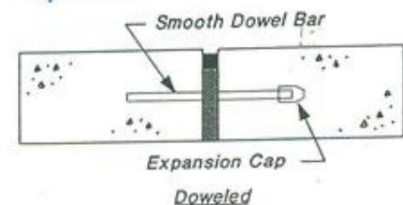

Construction:

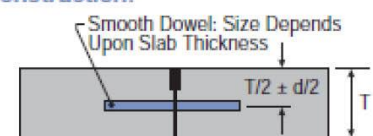

Type E – Doweled Butt

- Isolation Joints

- Introduction of “expansion” joints on a regular spacing tends to allow slabs to migrate because contraction joints in interior areas of a concrete pavement open unnecessarily. This unintended consequence degrades the effectiveness of aggregate interlock at the contraction joints and reduces the overall performance of the pavement. That is why, the traditional “expansion” joint has been modified to “isolation”.
- Are used to separate intersecting pavements and to isolate embedded fixtures within or along the pavement such as in-pavement drains.
- Where horizontal and vertical differences in movement (or dissimilar axis) of the pavements and traffic loads are anticipated, a thickened edge isolation is necessary to reduce edge tensile stress in the pavement.
- If the isolation joint is used along a pavement non-load area, then a simple butt joint is required
- Undoweled isolation joints allow the pavement freedom of movement laterally and an embedded fixture freedom of movement vertically, with no mechanical interconnection. Separation with each is provided with a non-extruding compressible material.

Isolation:

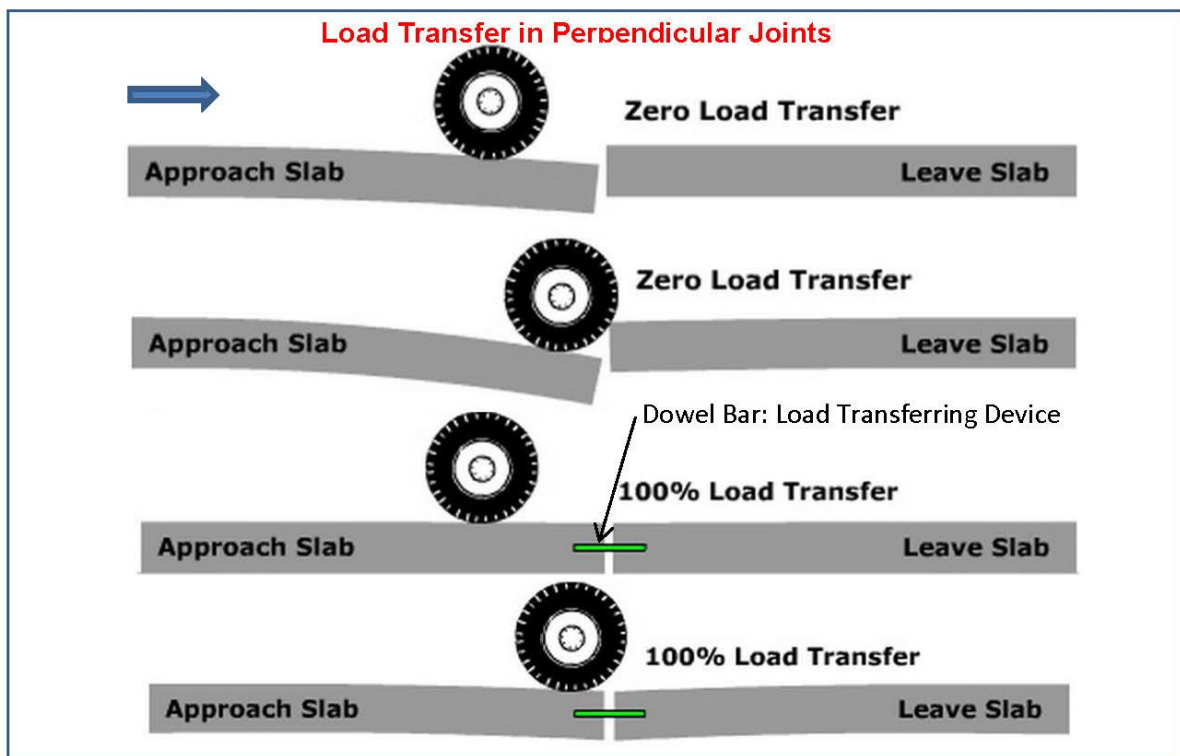
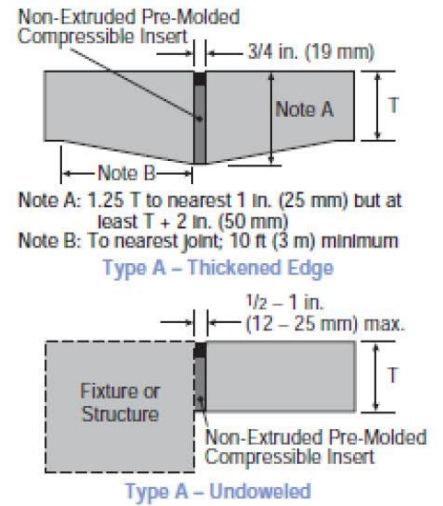

C. Layout-wise - w.r.t. direction of travel

- Perpendicular joints
- Skewed joints
- Staggered Joints

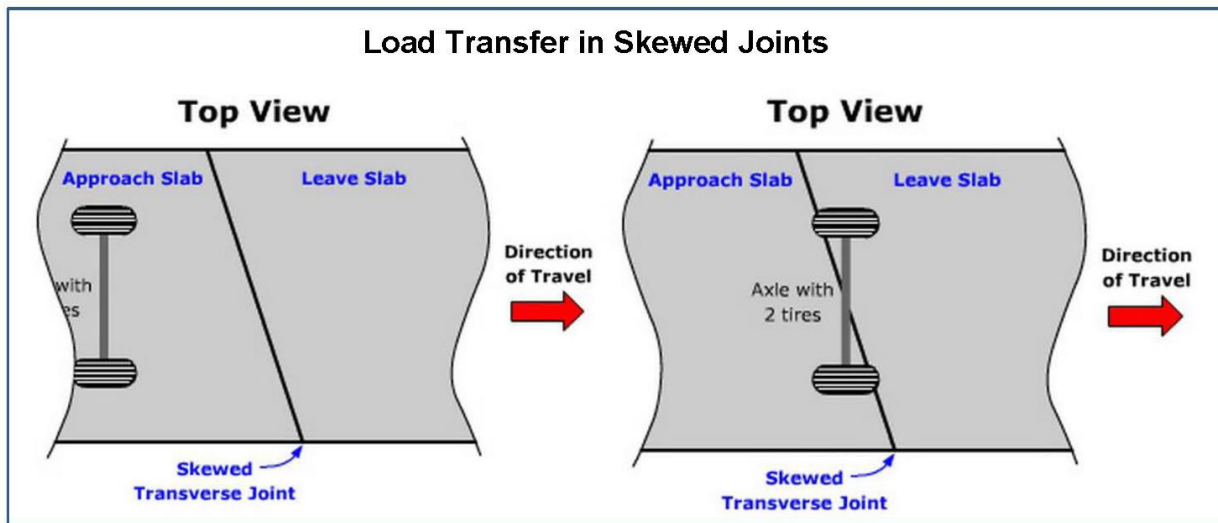
**Selection Criteria of slab length or Panel Sizes****A. Longitudinal Joint Considerations**

Longitudinal joints are those joints parallel to the lanes of construction and usually the direction of traffic. They are either contraction joints that are sawed between the construction joints or construction joints that are formed as the edges of construction lanes.

Longitudinal Joint Spacing – The pavement thickness and the overall width of the pavement are the primary factors determining the spacing of longitudinal joints. A longitudinal joint spacing that divides the pavement section evenly is most advantageous, reliable and recommended. For example, 37.5 ft (11.5 m) wide construction lanes can be used with intermediate longitudinal contraction joints at 12.5 or 18.75 ft (3.8 or 5.7 m), depending upon pavement thickness. The spacing of longitudinal (and transverse) joints also depends upon

- shrinkage properties of the concrete
- soil conditions
- subbase materials
- climatic conditions
- and slab thickness.

The following Table 1, lists the recommended maximum longitudinal joint spacing for concrete pavements built on unstabilized (granular) or stabilized subbases. Panels kept to dimensions shorter than the lengths listed in Table will have curling and warping stresses within acceptable limits and minimal risk of uncontrolled cracking.

Table 1: Recommended Maximum Joint Spacing

Concrete Pavement on an Unstabilized (Granular) Subbase		
Slab Thickness	Maximum Longitudinal Joint Spacing	Maximum Transverse Joint Spacing
6 in. (150 mm)	12.5 ft (3.8 m)	12.5 ft (3.8 m)
7-9 in. (175-230 mm)	15 ft (4.6 m)	15 ft (4.6 m)
> 9 in. (230 mm)	20 ft (6.1 m)	20 ft (6.1 m)
Concrete Pavement on a Stabilized Subbase		
Slab Thickness	Maximum Longitudinal Joint Spacing	Maximum Transverse Joint Spacing
8-10 in. (203-254 mm)	12.5 ft (3.8 m)	12.5 ft (3.8 m)
11-13 in. (279-330 mm)	15 ft (4.6 m)	15 ft (4.6 m)
14-16 in. (356-406 mm)	18.75 ft (5.7 m)	17.5 ft (5.3 m)
> 16 in. (406 mm)	20 ft (6.1 m)	20 ft (6.1 m)

B. Transverse Joint Considerations

Transverse contraction joints create a weakened plane at planned locations perpendicular to the direction of paving in order to control where cracks form. Sawing the pavement creates transverse contraction joints and the saw kerf depth for contraction joints is most effective if it is at least **one-fourth** of the slab thickness. For pavement constructed on stabilized subbase, a saw kerf of **one-third** the thickness of the pavement is most effective.

Joint Spacing – Table 1 lists the recommended maximum transverse joint spacings for concrete pavements built on unstabilized (granular) or stabilized subbases. It should be noted, however, that the climate and concrete aggregate common to some geographic regions may allow transverse joints to be further apart, or require them to be closer together than listed in Table 1. For example, concrete made from granite and limestone coarse aggregate is much less sensitive to temperature change than concrete made from siliceous gravel, chert, or slag aggregate. A less temperature-sensitive concrete does not expand or contract much with temperature change, which allows a longer spacing between pavement contraction joints without any greater chance of random cracking.

Aspect Ratio Limit – Performance has shown that it is desirable to have panels with approximately equal transverse and longitudinal joint spacing. When slabs are long and narrow, they tend to crack under traffic into smaller pieces of nearly equal dimensions, as is alluded to in Table 1. Panels are not likely to develop an intermediate crack if the length-to-width ratio does not exceed 1.25. This ratio may be difficult to maintain within intersections and can be disregarded in favor of common-sense jointing patterns.

Butt Joints – Transverse construction joints are necessary at the end of paving each day or where paving operations are suspended for 30 minutes or more. If the construction joint occurs at or near the location of a transverse contraction joint, a doweled butt joint is recommended.

Odd-Shaped Panels – The odd-shaped panels that result in the road intersection areas where pavements intersect require the use of embedded steel. Cracks may form in odd shaped panels. A steel quantity of 0.05 % of the cross-sectional area in both directions is adequate for slabs where the length-to-width ratio exceeds 1.25 or in slabs that are not rectangular in shape.

In the intersection, to reduce the risk of cracking in odd-shaped panels of curve areas,

- the last 3 ft (1 m) of all joints need to align perpendicular to the perimeter edge of the pavement and along a radial line.
- need to avoid layout patterns that create acute angles less than 60 degrees. Regardless of the situation, creation
- need to avoid creating a slab less than 2 ft (0.6 m) wide.

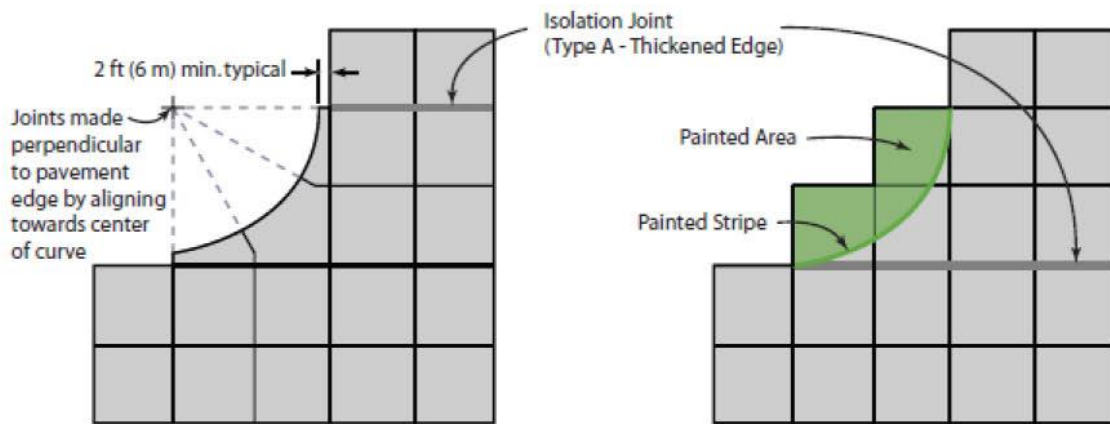

Sealing Joints

Joint sealants are used in pavement joints to keep out incompressible material and to minimize infiltration of water. To perform well, sealant materials must be capable of withstanding repeated extension and compression as the pavement slabs expand and contract with temperature and moisture changes. The size and shape of the sealant cross-section affects the sealant material performance.

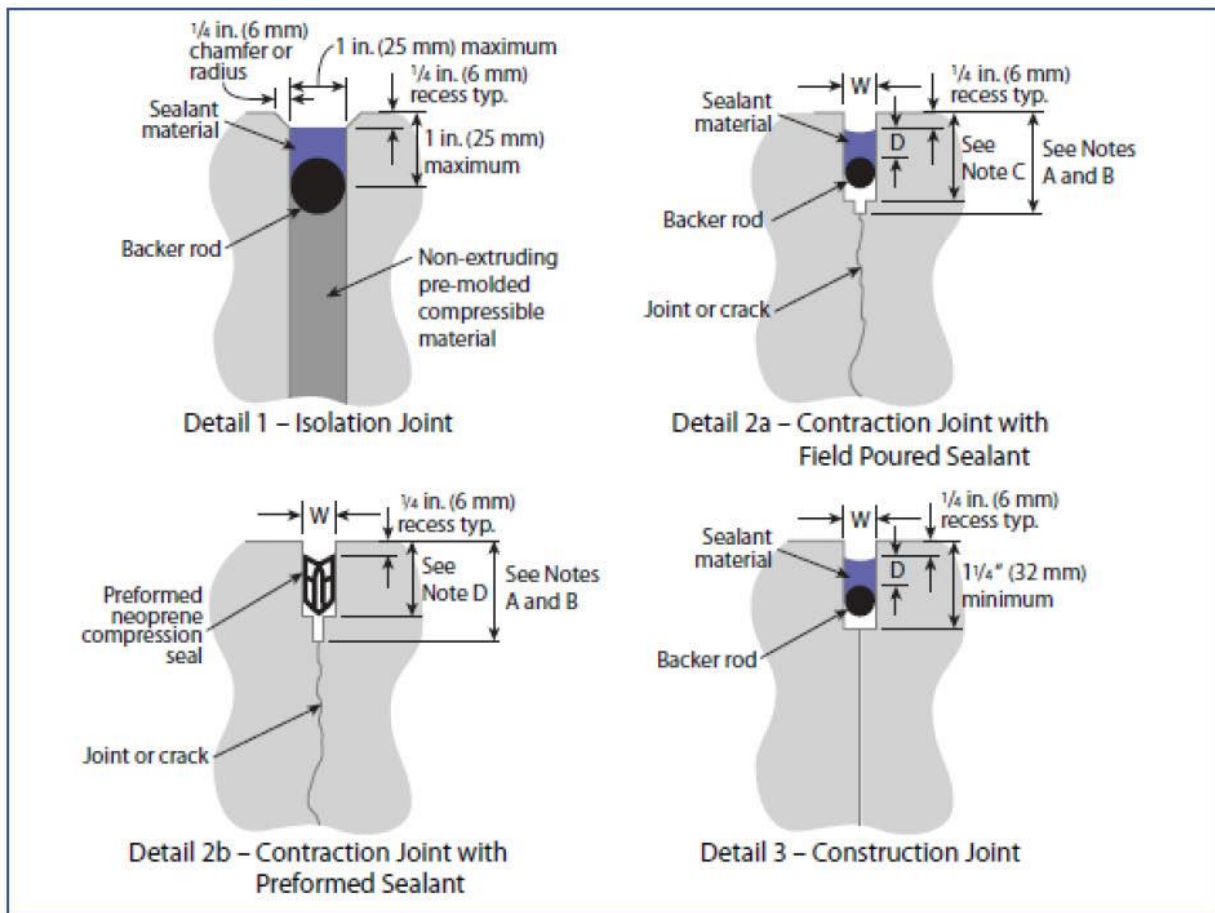

Joint Reservoir Details

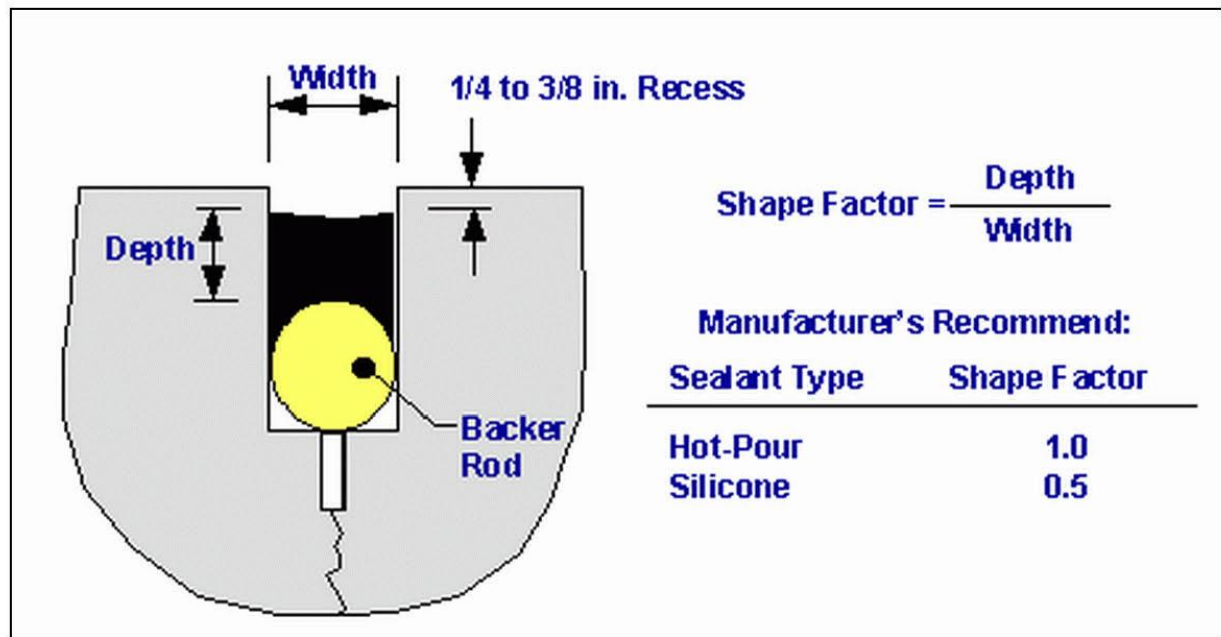
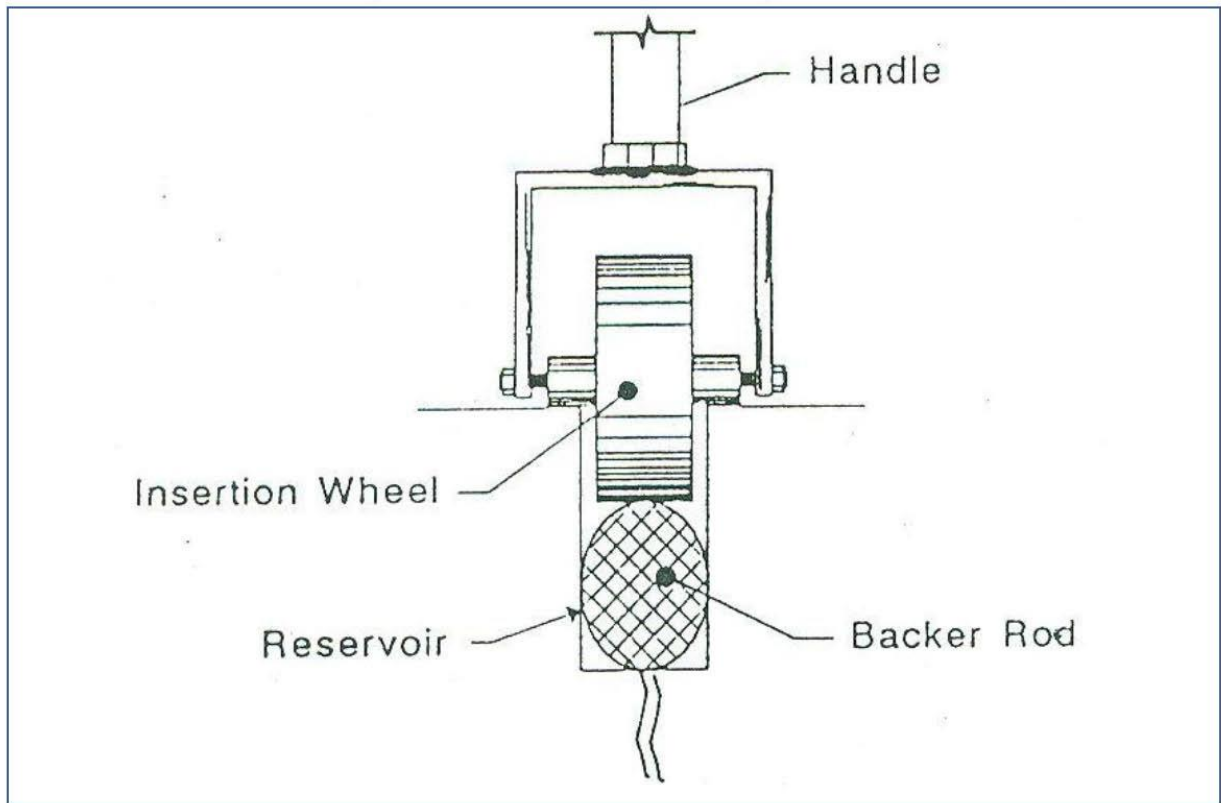

Roller Compacting Concrete



Porous Concrete



Rigid Runway Pavement

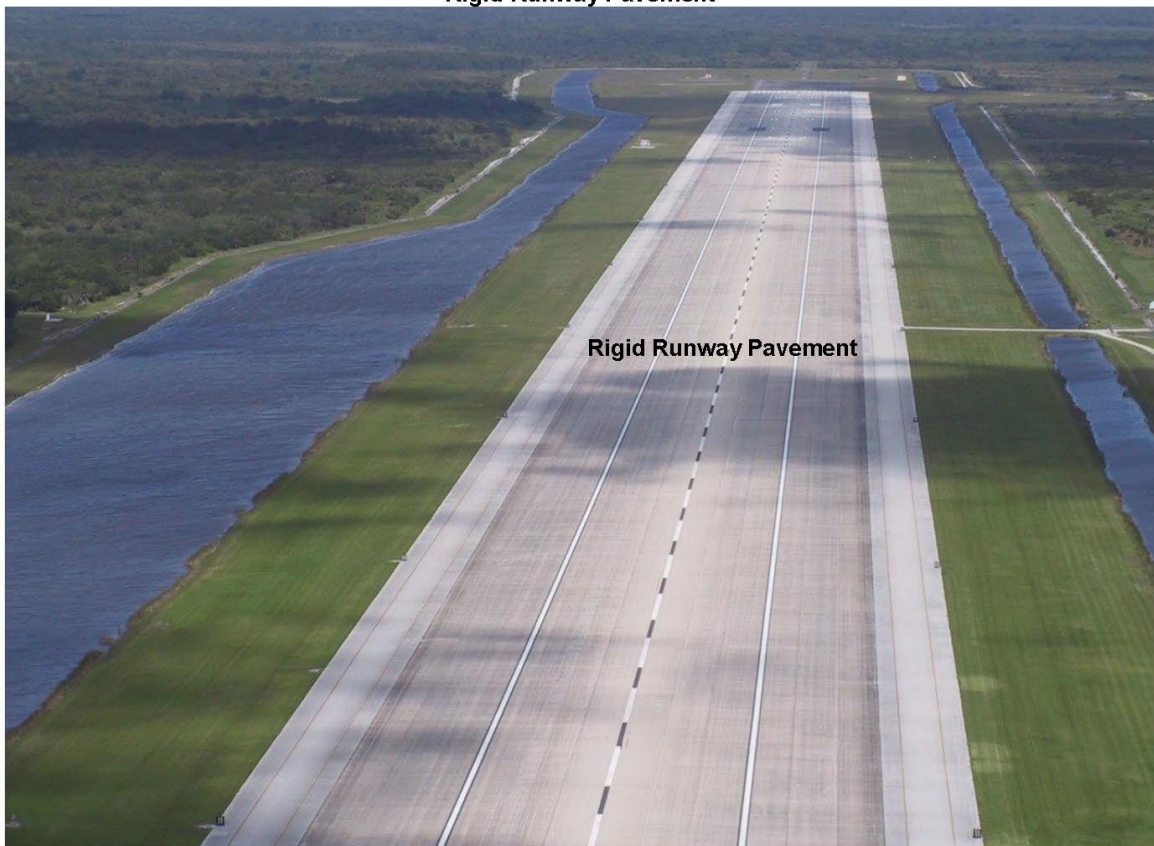

Why Joints are used in rigid Pavement?

1. To reduce influence of weathering as well as to reduce requirement of reinforcement
2. To control cracks
3. To accommodate pavement movements

What is the difference between tie bars and dowel bars?

- Tie bars are deformed rebars or connectors used for holding faces of rigid slabs in contact to maintain aggregate interlock. Tie bars are not load transferring device. For instance, tie bars are used in longitudinal joints in concrete pavement.
- Dowel bars are smooth round bars which mainly serve as load transfer device across concrete joints. They are placed across transverse joints of concrete pavement to allow movement to take place. Where movement is purposely designed for longitudinal joints, dowel bars can be adopted.

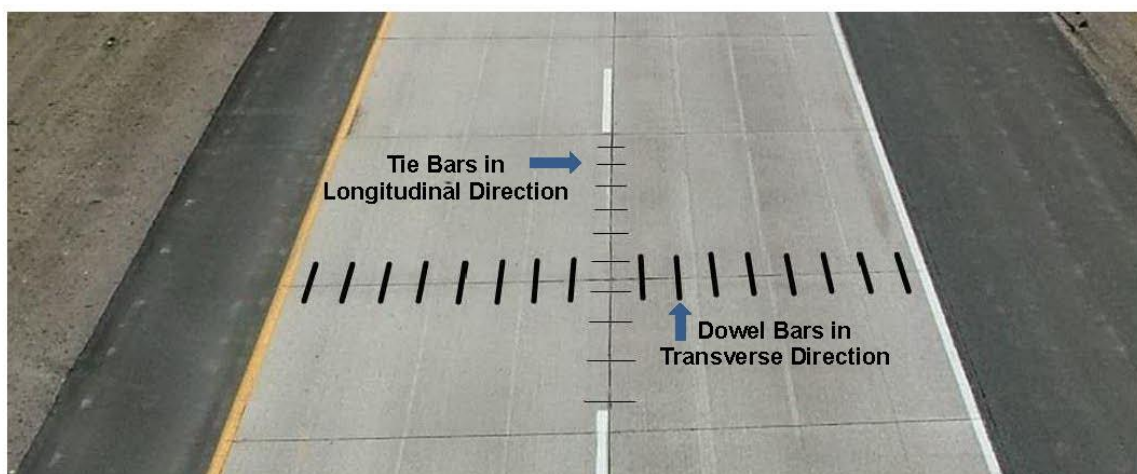
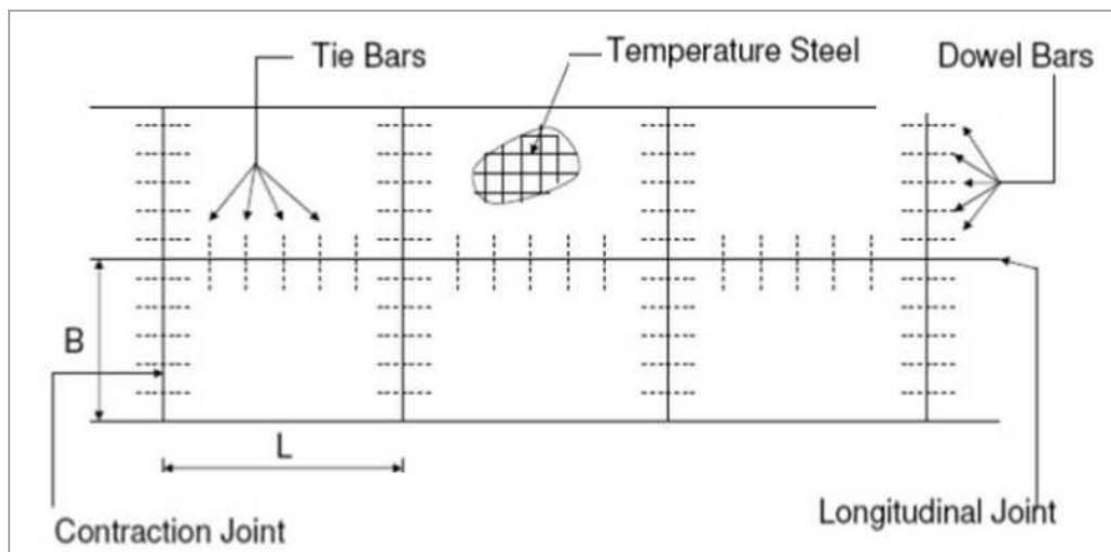
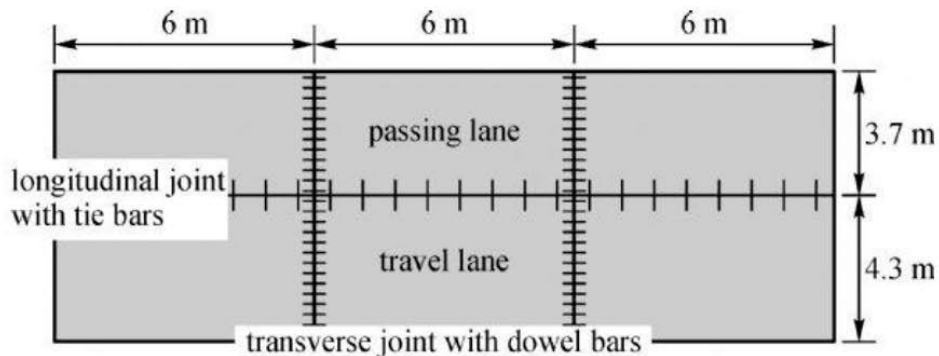

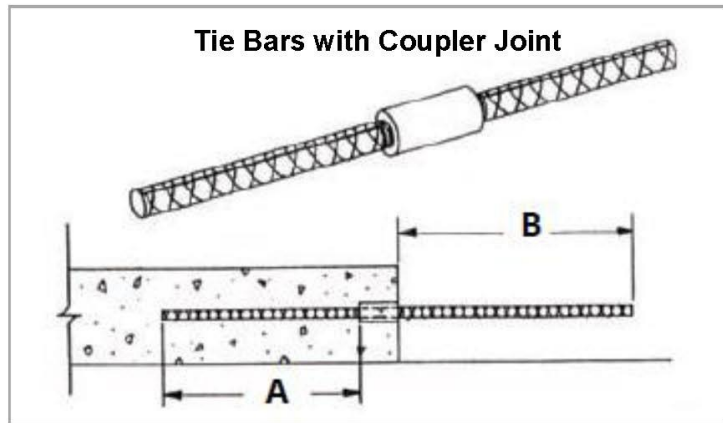
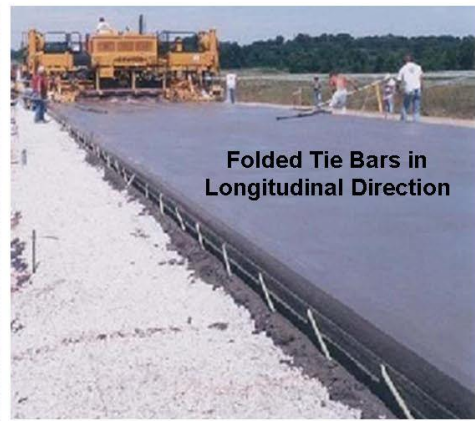

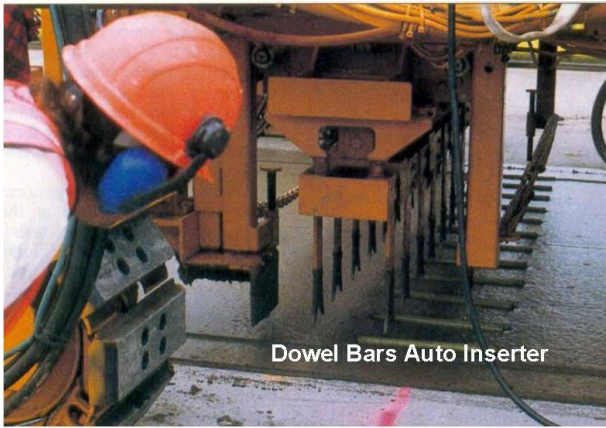

Dowel Bars Auto Inserter

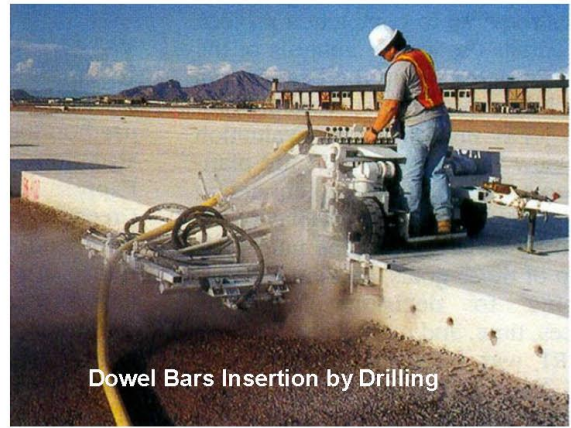

Dowel Bars Insertion by Drilling



Dowel Bars Insertion by Saw Cutting



Dowel Bars Insertion by Saw Cutting



Sawed



Sawed Contraction Joint



Construction Joint by using Steel Plate

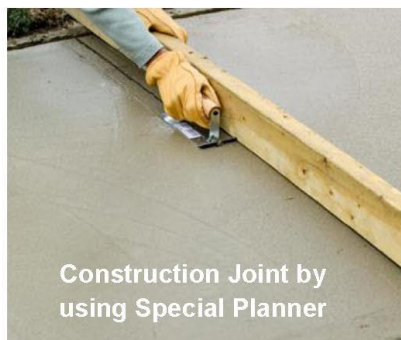

Construction Joint by using Special Planner



Steel Planner Cutting Tool



Joint-wise Rigid Pavement Types

a. Stabilised sub-base

- Cement treated subbase/base add to the structural capability of pavement &
- also assist in load transfer across joints without dowel bars
- therefore, use of short slabs (increase no. of joints) and a cement-treated sub-base sometimes go hand in hand

b. Plain Versus Reinforced Pavements

- Jointed Plain Concrete Pavements (JPCP):
 - o no temperature reinforcement is required
 - o no contraction joints
 - o Transverse joint spacing is selected such that temperature and moisture stresses do not produce intermediate cracking between joints
 - o dowel bars are typically used at transverse joints to assist in load transfer. Tie bars are typically used at longitudinal joints.
 - o dowel bars can be omitted if stabilised sub-base is used
 - o suitable for
 - pavements that will carry low volume of traffic and
 - slab length is <6m or 20'
- Jointed Reinforcement Concrete Pavements (JRCP):
 - o Transverse joint spacing is longer than that required for JPCP
 - o Usually used when slab length lies in between 6m (20') to 15m (50')
 - o JRCP uses contraction joints and reinforcing steel to control cracking
 - o dowel bars are needed at the joints to assist with load transfer
 - o JRCP is suitable for pavements that will carry medium volume of traffic

Top View

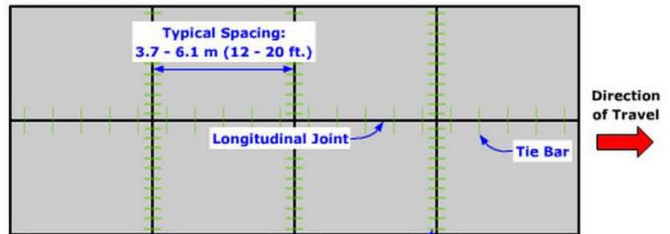

Side View

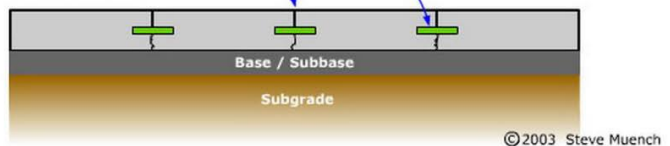

Jointed Plain Concrete Pavement (JPCP)

©2003 Steve Muench

Top View

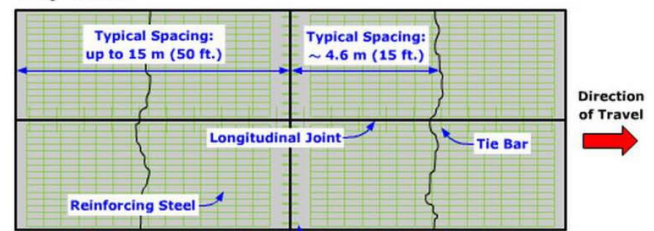

Side View

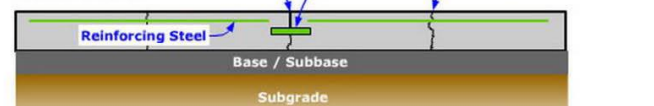

Jointed Reinforced Concrete Pavement (JRCP)

©2003 Steve Muench

- Continuously Reinforced Concrete Pavements (CRCP):
 - o when slab length is > 15m or 50'
 - o CRCP provides joint-free design. The formation of transverse cracks at relatively close intervals is a distinctive characteristic of CRCP.
 - o Cracks are held tightly by the reinforcement and should be of no concern as long as the cracks are uniformly spaced, do not spall excessively, and a uniform non-erosive base is provided.
 - o no need for contraction joints

Top View

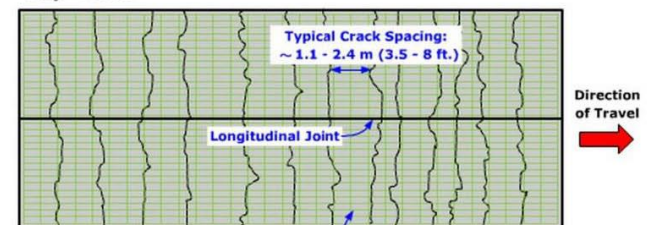

Side View

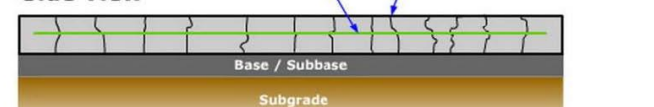

Continuously Reinforced Concrete Pavement (CRCP)

©2003 Steve Muench

Comparison between Flexible and Rigid Pavements

Flexible Pavements	Rigid Pavements
Layer system	
Consists of several layers: <input type="checkbox"/> Surface course <input type="checkbox"/> Base course <input type="checkbox"/> Sub-base course (may or may not) <input type="checkbox"/> Subgrade (compacted/improved soil) <input type="checkbox"/> Roadbed (natural soil)	Usually single layered <input type="checkbox"/> With portland cement concrete surface <input type="checkbox"/> Base course may or may not be used
Load carrying/distribution mechanism	
Each layer <input type="checkbox"/> Carry a fraction of total load <input type="checkbox"/> Distribute it gradually, due to aggregate interlocking/frictions/shearing, over a wider area than the previous layer <input type="checkbox"/> Finally over a wide area of roadbed and thereby protect the roadbed being overstressed	<input type="checkbox"/> A major portion of the load carried by the slab itself <input type="checkbox"/> Distribute it over a relatively wide area of roadbed
Aggregate Type	
<input type="checkbox"/> Aggregates with high angularity are required to ensure good interlocking	<input type="checkbox"/> Rounded aggregates may be used as they only fill the voids
Resistance/Stability	
<input type="checkbox"/> Stability comes from aggregate interlocking, shearing	<input type="checkbox"/> Bending (beam) action of concrete slab
Modulus of Elasticity	
<input type="checkbox"/> Each layer is flexible with low modulus of elasticity	<input type="checkbox"/> Surface course is very rigid with high modulus of elasticity
Design Concept	
<input type="checkbox"/> Factor considered in the design is the different layer system (each layer must be capable of sustaining the load intensity of that layer) <input type="checkbox"/> Minor variation in any layer strength has pronounced influence upon riding quality of the pavement (due to rutting). <input type="checkbox"/> Since intensity of traffic load is maximum at the surface - highest quality of material is used at or near the surface	<input type="checkbox"/> Factor considered here is the structural strength of the concrete. <input type="checkbox"/> Minor variation in roadbed strength has little influence upon the structural capability of the pavement.
Main Modes of failure	
<input type="checkbox"/> Rutting <input type="checkbox"/> Fatigue <input type="checkbox"/> Shear	<input type="checkbox"/> Fatigue <input type="checkbox"/> Join failure <input type="checkbox"/> Temperature cracks
Advantages	
<input type="checkbox"/> Low initial investment <input type="checkbox"/> Offer stage construction <input type="checkbox"/> Easy to maintain/correct foundation error <input type="checkbox"/> Give smooth riding quality (in hilly area/rolling terrain it is the better option) <input type="checkbox"/> Offer high skid resistance <input type="checkbox"/> Non-slippery even in wet condition <input type="checkbox"/> Produce low level of noise <input type="checkbox"/> Cutting/digging road side trench for upgradation of utility services is easier <input type="checkbox"/> Can be open for traffic immediately after construction <input type="checkbox"/> Recycling is easier	<input type="checkbox"/> Can deal with very heavy traffic <input type="checkbox"/> Very long life span <input type="checkbox"/> Require little maintenance <input type="checkbox"/> Give good light reflectance quality <input type="checkbox"/> Provide pleasing appearance <input type="checkbox"/> They perform quite satisfactory even when constructed on poor sub-grade <input type="checkbox"/> Less susceptible to weather - specially at submerged condition <input type="checkbox"/> Heating of aggregates and cement is not required
Disadvantages	
<input type="checkbox"/> High maintenance cost <input type="checkbox"/> Susceptible to weather - bleeding at high temperature, cracking at low temperature and stripping under submerged condition <input type="checkbox"/> Poor light reflectance quality <input type="checkbox"/> Short life span <input type="checkbox"/> Suitable for roads in residential and built-up areas <input type="checkbox"/> Required uniform support <input type="checkbox"/> Reflect the deformation of lower layers <input type="checkbox"/> Performance is very sensitive to surface as well as sub-surface drainage condition <input type="checkbox"/> Produce high built-up of superheated air layer above pavement surface or high ambient temperature	<input type="checkbox"/> High initial cost (but low life-cycle cost) <input type="checkbox"/> Difficult to repair and correct foundation error <input type="checkbox"/> Produce high noise due to wear and tear of vehicles <input type="checkbox"/> Up-gradation of different underground utility services is very difficult <input type="checkbox"/> Stage construction is not possible <input type="checkbox"/> Cannot be reconstructed. <input type="checkbox"/> At the end of pavement life, crushing of the layer is required before laying of new bituminous surface course

	<ul style="list-style-type: none"> <input type="checkbox"/> Before opening for traffic at least 28 days curing is required <input type="checkbox"/> After some time of use surface becomes smooth and slippery. <input type="checkbox"/> Suitable for roads in open areas where noise problem is not a big issue & no need to lay utility pipes.
Submerged Condition	
<ul style="list-style-type: none"> <input type="checkbox"/> Water is enemy for bituminous wearing course (stripping prob.) 	<ul style="list-style-type: none"> <input type="checkbox"/> Wearing course is water friendly (Concrete gains strength)
Quality Control Compliances	
<ul style="list-style-type: none"> <input type="checkbox"/> Aggregate quality, gradation & layer compaction <input type="checkbox"/> Stringent requirement of temperature control 	<ul style="list-style-type: none"> <input type="checkbox"/> W/C control <input type="checkbox"/> Curing control
Equipment Involvement	
<ul style="list-style-type: none"> <input type="checkbox"/> High no. of equipment is needed <input type="checkbox"/> Need involvement of heavy compaction equipment <input type="checkbox"/> Need heating facility <input type="checkbox"/> Need professional contractor 	<ul style="list-style-type: none"> <input type="checkbox"/> Involvement of equipment is minimum <input type="checkbox"/> For concreting work, no roller is needed <input type="checkbox"/> For low standard road, no need of involving professional contractor

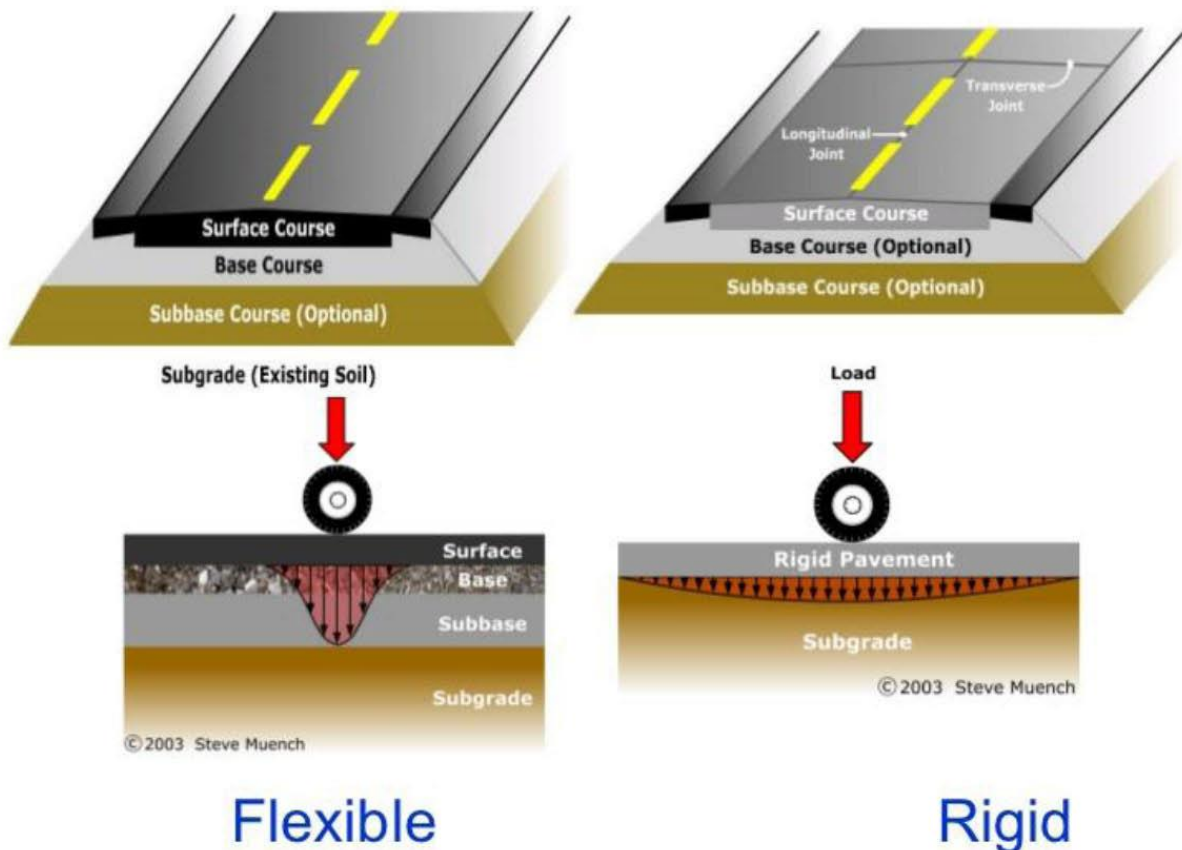

Stringent Temperature Compliances for Flexible Pavement

Temperature shall be controlled within the following limits.

Binder	135 - 183°C
Aggregate (ex-dryer)	140 - 165°C
Mix (pug mill)	135 - 165°C
Delivery (paver)	130°C minimum
Rolling (initial)	110°C minimum

Glare and night visibility:

Concrete is naturally brighter and more reflective than asphalt. This requires less energy to illuminate comparable areas, which is good for the environment.

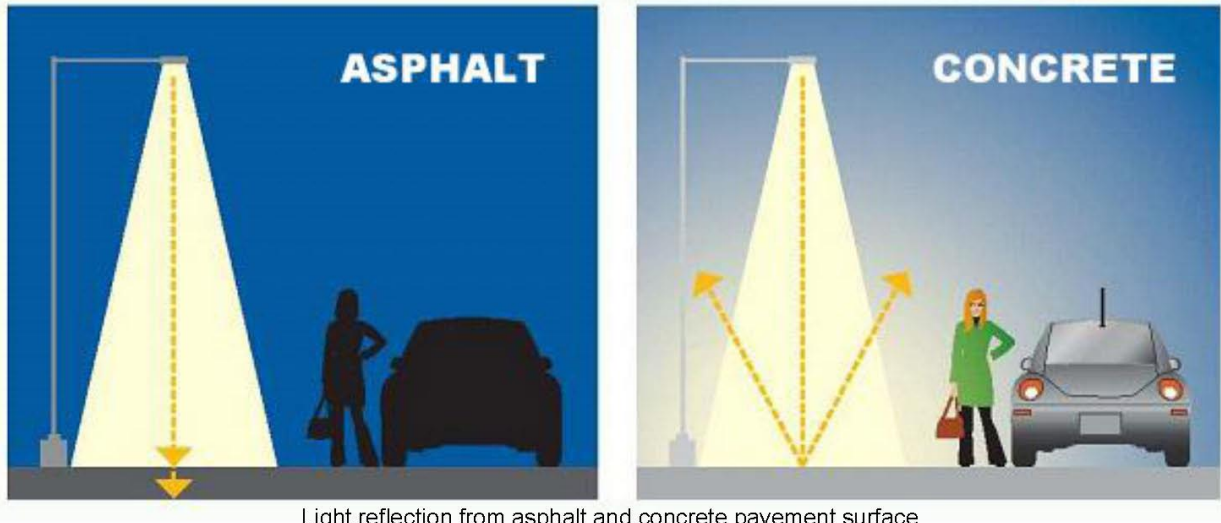

Light reflection from asphalt and concrete pavement surface

To overcome the lack of light reflectance, an asphalt pavement requires either:

- (1) more street lights per km than a concrete pavement, or
- (2) higher watt light bulbs at the same light pole spacing as a used on a concrete pavement.

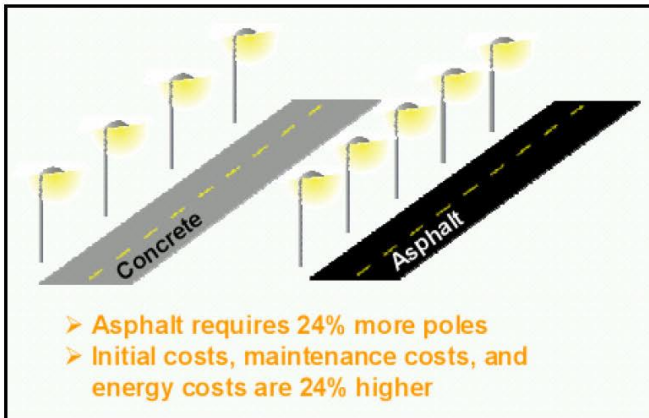

More street poles needed for asphalt pavement

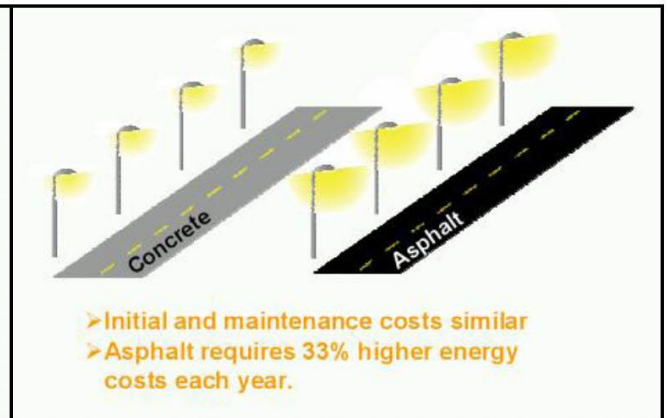

Higher watt bulbs needed for asphalt pavement



Night time light reflectance contrast between Flexible & Rigid pavements

Safety (w.r.t Skid resistance and Minimum Stopping Distance) :

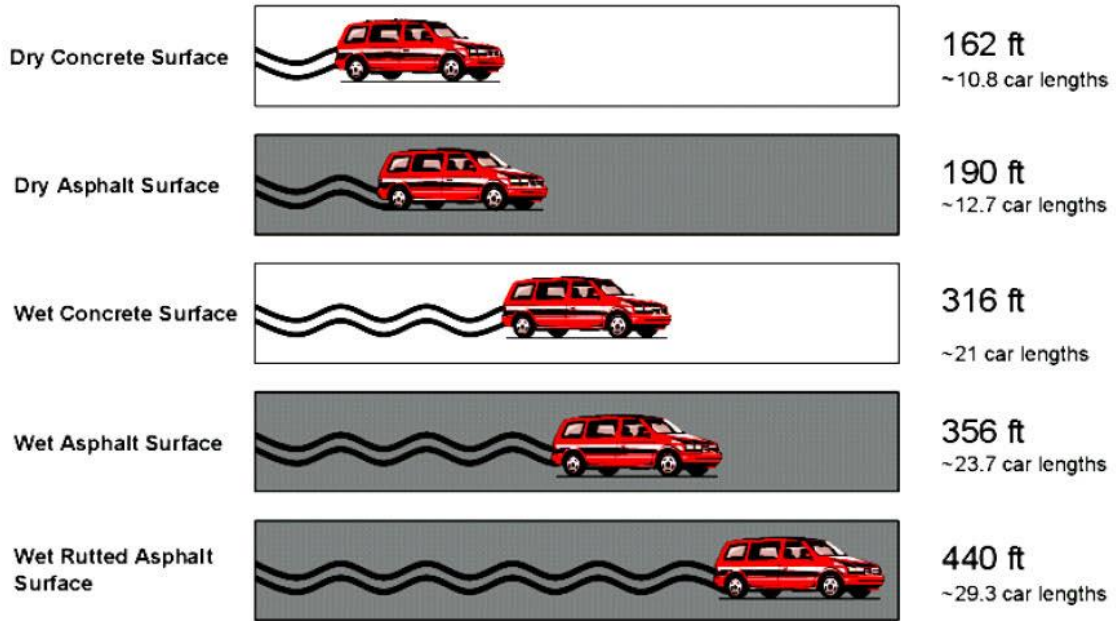

Source: Chevrolet stopping data (not anti-lock brakes) from report "Safety Considerations of Rutting and Washboarding Asphalt Road Surfaces," Department of General Engineering, University of Illinois, 1989.

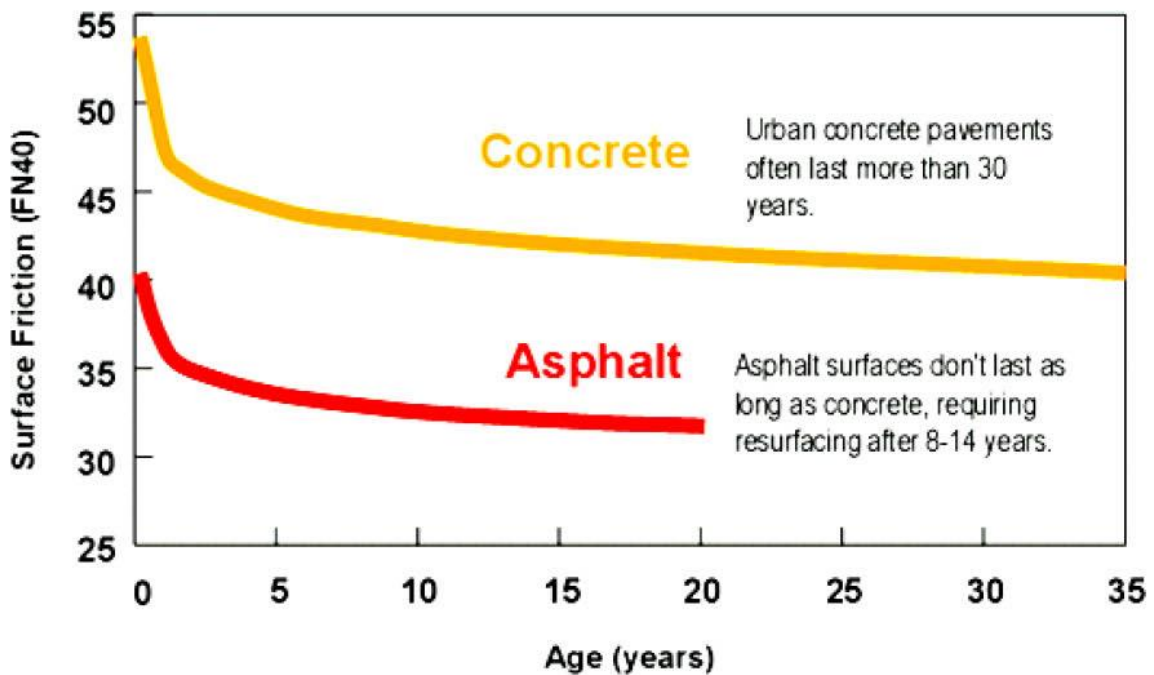

Source: Wisconsin Pavement Performance Report. Wisconsin Department of Transportation. Madison, WI., 1996.

Concrete Pavement provides fuel savings for heavy vehicles:

Heavy vehicles cause greater deflection on flexible pavements than on rigid pavements. This increased deflection of the pavement absorbs part of the vehicle energy that would otherwise be available to propel the vehicle, thus, the hypothesis can be made that more energy and therefore more fuel, is required to drive on flexible pavements. Concrete's rigid design reduces road deflection and corresponding fuel consumption. A study for the Federal Highway Administration (FHWA) to update The difference in fuel consumption performance of heavy vehicles operating on concrete and asphalt pavements shows that the savings in fuel consumption for heavy vehicles traveling on concrete versus asphalt pavements was up to 20%.

Penetration of water:

A cement concrete slab is practically impervious, except at joints. If joints are sealed and well maintained, water will not penetrate and soften the subgrade. A bituminous surface is not impervious. Water can find its way into the lower layers through cracks and pores. Such water can impair the stability of the pavement.

Utility location:

For concrete pavement it is difficult to rip open the slab and restore it to the original condition if any changes in the utility lines are to be made. For this purpose, gaps are left in the pavement. In flexible pavement random cut in pavement structure is possible. So for an unplanned and densely populated city flexible pavement is preferable because utility cutting is a very common feature in these road areas.

Traffic dislocation:

A cement concrete pavement requires 28 days before it can be thrown open to traffic. On the other hand a bituminous surface can be thrown to open to traffic shortly after it is rolled. So from construction point of view concrete pavement cause longer dislocation of traffic than flexible pavements. But maintenance work needed for flexible pavement is very frequent than rigid pavement, which causes small dislocation or disturbance of traffic very frequently over the life time of flexible pavement.

Pavement Recycling:

All pavements eventually have to be replaced. In case of concrete pavement recycling, the recycled material is used as granular fill, base course for new pavement, or as aggregate to strengthen new concrete pavement. Asphalt pavement can be recycled as "Reclaimed Asphalt Pavement" (RAP). RAP is essentially old pavement that is reclaimed for use. In its most common form, it is collected in loose granular form as a byproduct of pavement rehabilitation or reconstruction (see Figures 1 and 2). RAP can be used in a variety of ways such as:

- As an addition to regular HMA.
- As an aggregate in cold-mix asphalt.
- As a granular base course when pulverized.
- As a fill or embankment material.

Environmental Consideration:

During construction of a flexible pavement where bituminous layers are to be provided, the process of heating of bitumen and aggregates and mixing them together in hot-mix plants, can prove to be much more hazardous to the environment than cement concrete construction where no heating of any material is involved. Use of bitumen cutbacks can also prove to be environmentally hazardous due to evaporation of volatile constituents into the atmosphere. Concrete pavements are a key element of the "Cool Communities Movement"; concrete surfaces can be 30°F to 70°F cooler than asphalt surfaces.

Concrete pavement is longer lasting and therefore environment friendly in a sense that

- a) They don't need to be rehabbed or reconstructed as often.
- b) This means fewer raw materials are used both in the short term and over the life of the pavement.
- c) This also means fewer pollutants are going into our water, air, and soil.
- d) It also result in less energy being used in construction. i.e. less motor fuels and oils are needed for heavy construction equipment.
- e) Longer lasting concrete helps reduce traffic congestion because there are simply fewer construction work zones slowing traffic flow.

Concrete pavements are a key element of the "Cool Communities Movement"; concrete surfaces can be 30°F to 70°F cooler than asphalt surfaces

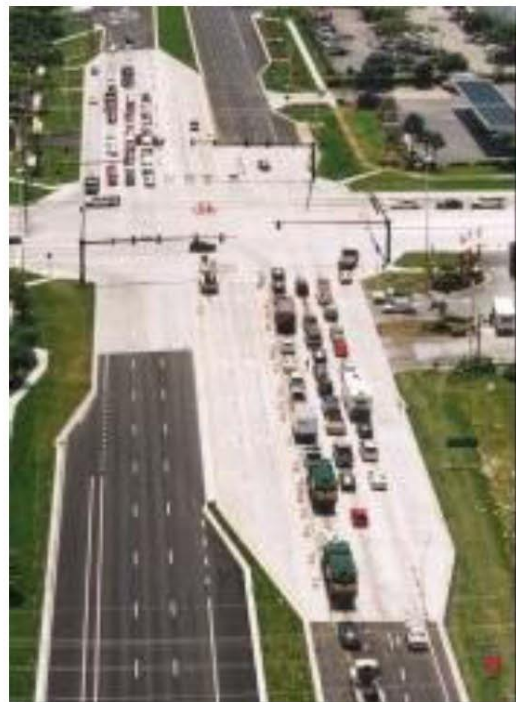



Equipment Arcade for the Construction of Flexible Pavements





Equipment Arcade for the Construction of Rigid Pavements





Quality Control of Rigid Pavement



Curing of Rigid Pavement



Saw Cutting Equipment for making Construction Joint

Where rigid pavements are warranted ?

1. Where extra performance (due to stationary/slow loading condition, stopping & starting, impact) is needed:
 - Junction
 - Bus pul-out/bay
 - Toll plaza
 - Level x-ing
 - Runway threshold / truning area
 - Taxiway
2. Road at Narrow (Lane by-lane) / Remote area (Roller accessibility problem)
3. Channelized/guided Traffic
4. Inundation / Submerssible potential
5. Heavy duty pavements (Sea Port and Airport)





Submersible Concrete Road



Submersible Concrete Road



**Concrete Road on tight r.o.w.
(Roller inaccessible)**



Concrete Road on tight r.o.w.



Concrete Road on guided busway



Concrete Twin-Track Road on guided busway



Normal Level Crossing



Concrete at Level Crossing



Concrete road at tight by-lane



Concrete road at tight by-lane
(Roller inaccessible)



Concrete Road without embankment



Concrete Road without embankment



Concrete Yard at Sea Port Container Yard



Concrete Track at Sea Port Container Yard



Concrete Runway End at Airport Port

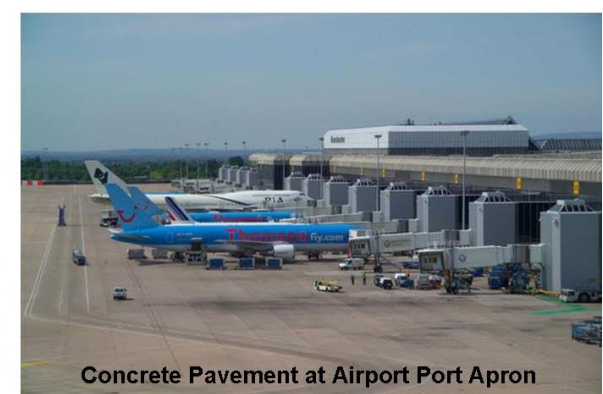

Concrete Pavement at Airport Port Apron

Rigid Pavement at Runway Turn Around Area

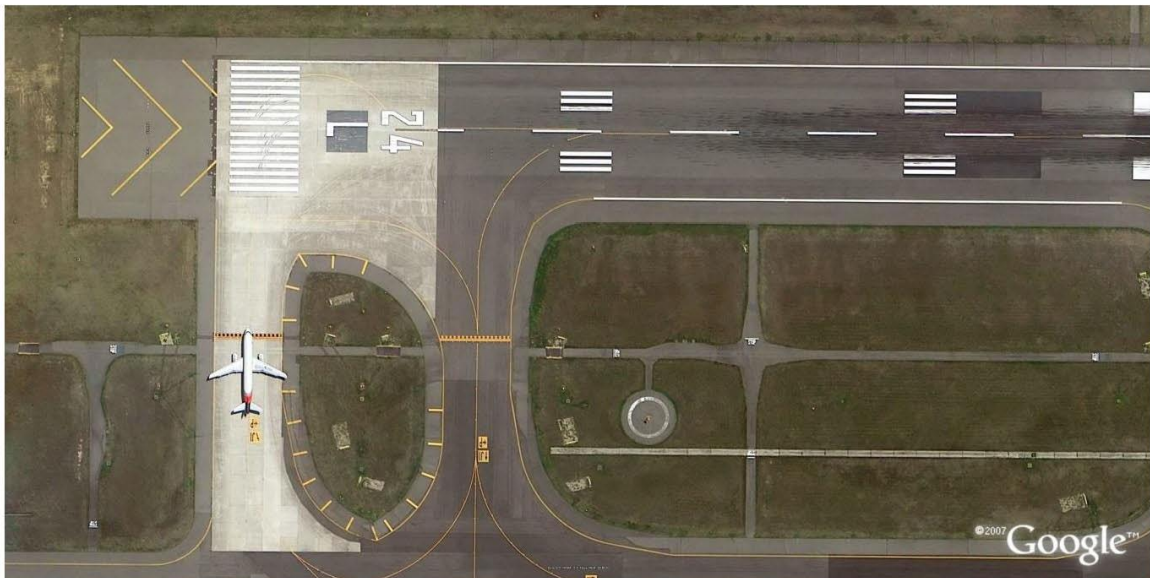

Perpetual Pavement

INTRODUCTION

Advancements in compaction, high performance binder, material transfer vehicle (MTV), asphalt reinforcement and HMA technology over the last few decades have created HMA pavements that perform better, longer and with lower life-cycle costs than was previously possible. Today's HMA pavements can be designed to last in perpetuity.

DEFINITION

A Perpetual Pavement is defined as a HMA pavement designed and built to last longer than 50 years without requiring major structural rehabilitation or reconstruction, and needing only periodic surface renewal in response to distresses confined to the top of the pavement.

CONCEPT

The concept of Perpetual Pavements, or long-lasting HMA pavements, is not new. Full-depth and deep-strength HMA pavement structures have been constructed since the 1960s and before, and those that were well-designed and well-built have been very successful in providing long service lives under heavy traffic (APA, 2002). The basic concept is that HMA pavements over a minimum strength are not likely to exhibit structural damage even when subjected to very high traffic flows over long periods of time. Rather, deterioration seems to initiate in the pavement surface as either top-down cracking or rutting. If surface-initiated cracking and rutting can be detected and remedied before they impact the structural integrity of the pavement, the pavement design life could be greatly increased. In fact, some HMA pavements in service today are living examples of perpetual pavements.

In order to work, the above pavement structure must be built on a solid foundation (i.e. with subgrade with a CBR greater than 5%, low swell & settlement potential). Besides, as always, proper construction techniques are essential to a perpetual pavement's performance.

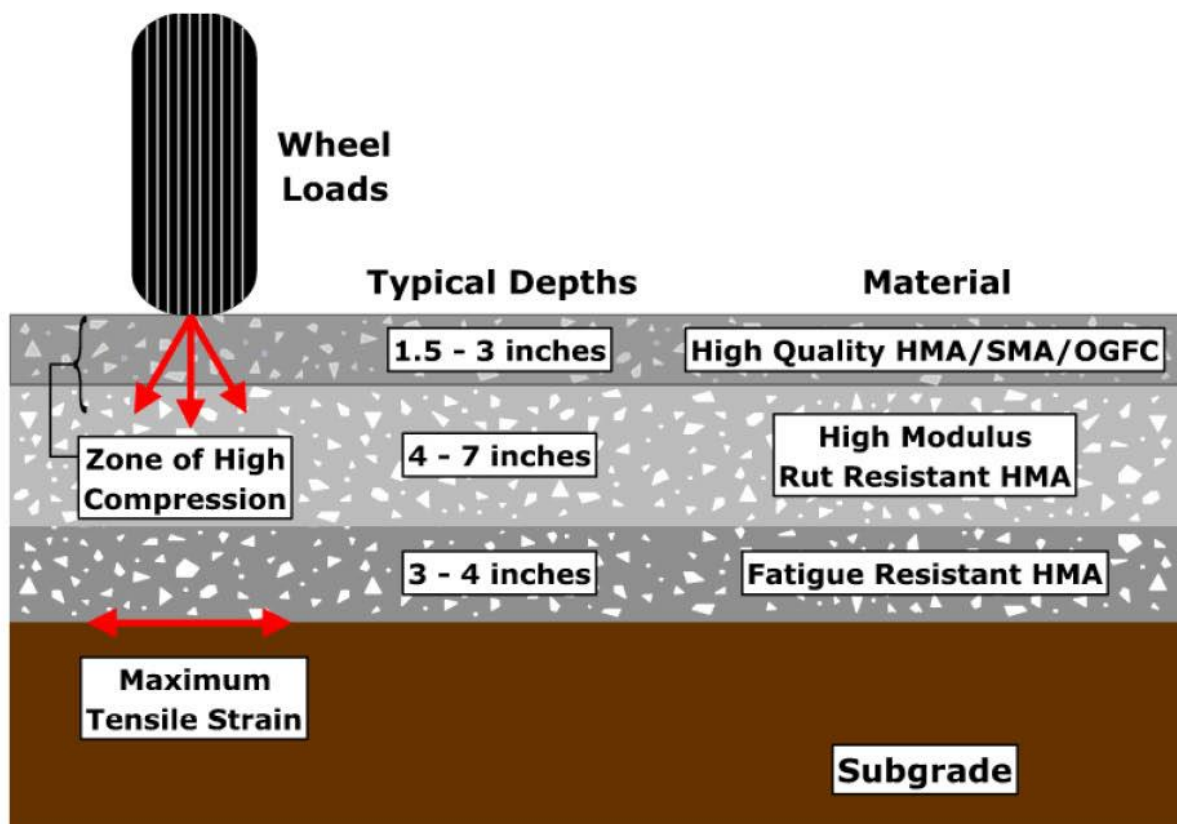

Figure 1: Perpetual pavement design concepts.

CONSIDERATIONS OF PERPETUAL PAVEMENT

1. Making pavement structure as a pure compression member by:
 - a. Building pavement structure on a solid foundation (i.e. subgrade with a CBR greater than 5%, low swell & settlement potential)
 - b. Proper layer compaction towards achieving uniform support condition (OMC, specified lift thickness, using Smart Dynamic Compactor with online compaction checking facility)
 - c. Ensuring adequate edge confinement/restraint
 - d. Ensuring – adequate sub-surface drainage facilities
2. Use of Polymer Modified Binder and Glass Grid/Geo-Grid as Asphalt Reinforcement
3. Plant based mix production – to ensure proper heating & mixing
4. Use of MTV (Material Transfer Vehicle) – to minimize aggregate & temperature segregation
5. Smart Paver based construction (GPS based) – to ensure even surface
6. Extending pavement life by:
 - a. Ensuring embankment stability
 - b. Enforcing overloading
 - c. Adopting Pavement Management Schemes
 - i. Constructing extra pavement strip and periodic shifting of markings
 - ii. Adopt twin-track system where applicable
 - iii. Construct Rigid pavement where extra performance is needed
7. Ensuring proper surface drainage facility & control of heavy vehicles under submerged condition

Making Pavement Structure as a pure Compression Member by Ensuring Proper Compaction



Making pavement structure as a pure compression member by ensuring uniform support

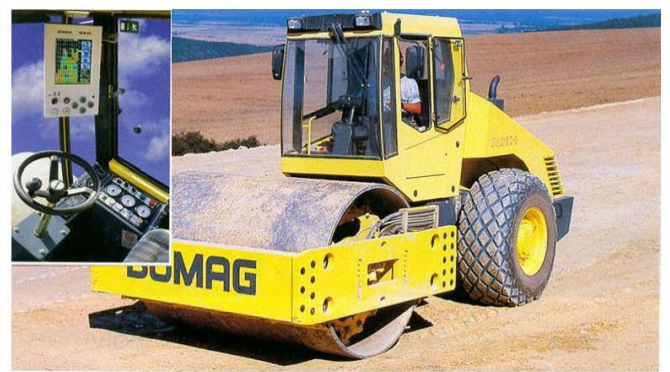

Ensuring adequate edge confinement/restraint



Ensuring adequate sub-surface drainage facilities



Use of Asphalt Reinforcement Glass-Grid/Geo-Grid



USE OF POLYMER MODIFIED BINDER (PMB)

WHAT ARE THE INHERENT WEAKNESSES OF CONVENTIONAL BITUMEN?

- is highly susceptible to temperature
- has low elastic recovery
- forms very thin film on aggregate

WHAT IS POLYMER?

Polymer is a non-biodegradable, very visco-elastic material.

SOURCES OF POLYMER

- Pure form/new – Pellets
- Scrap/reclaimed – tyre, polythene, plastic product



WHAT DO POLYMERS DO?

When a suitable polymer is blended with bitumen, it

- reduces temperature susceptibility & thereby reduce rutting & material flow potential
- imparts elastic property
- increases film thickness on the aggregate & thereby reduce stripping potential
- provides greater cohesion and binding strength
- Improves creep behavior

SIGNIFICANCE OF PMB IN BANGLADESH

- Heavy rainfall during monsoon causes inundation of pavement
- Lack of proper drainage facilities
- Roads and Highways endure severe congestion that induced flow of material in summer time
- Rampant overloading

Therefore, there is a need for pavement with extra performance binder or PMB.

Adoption of Plant based mix production to ensure proper heating & mixing (high quality mix)



Use of MTV (Material Transfer Vehicle) – to minimize temperature segregation

Material Transfer Vehicles (MTVs)

Material transfer vehicles (MTVs) are used to assist the paver in accepting HMA. Most pavers are equipped to receive HMA directly from end dump or live bottom trucks, however in certain situations it can be necessary or advantageous to use an MTV. Paving using bottom dump trucks and windrows requires a windrow elevator MTV, while other MTVs are used to provide additional surge volume, which is advantageous because it allows the paver to operate continuously without stopping, minimizes truck waiting time at the paving site and may minimize aggregate segregation and temperature differentials.



Paving Operation using Shuttle Buggy MTV

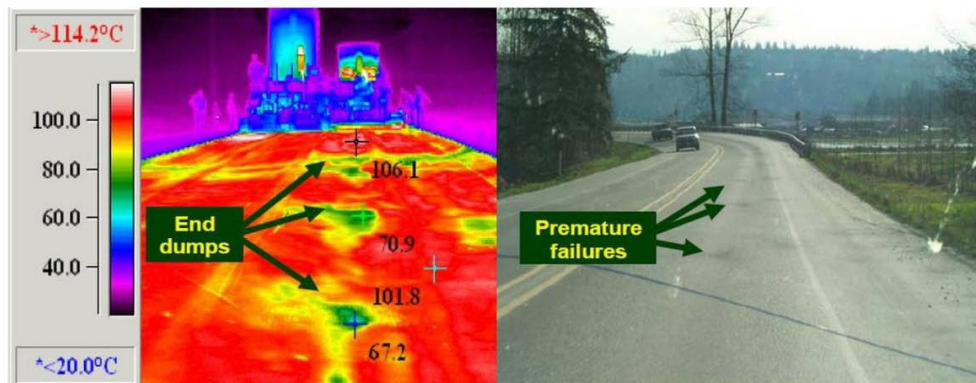
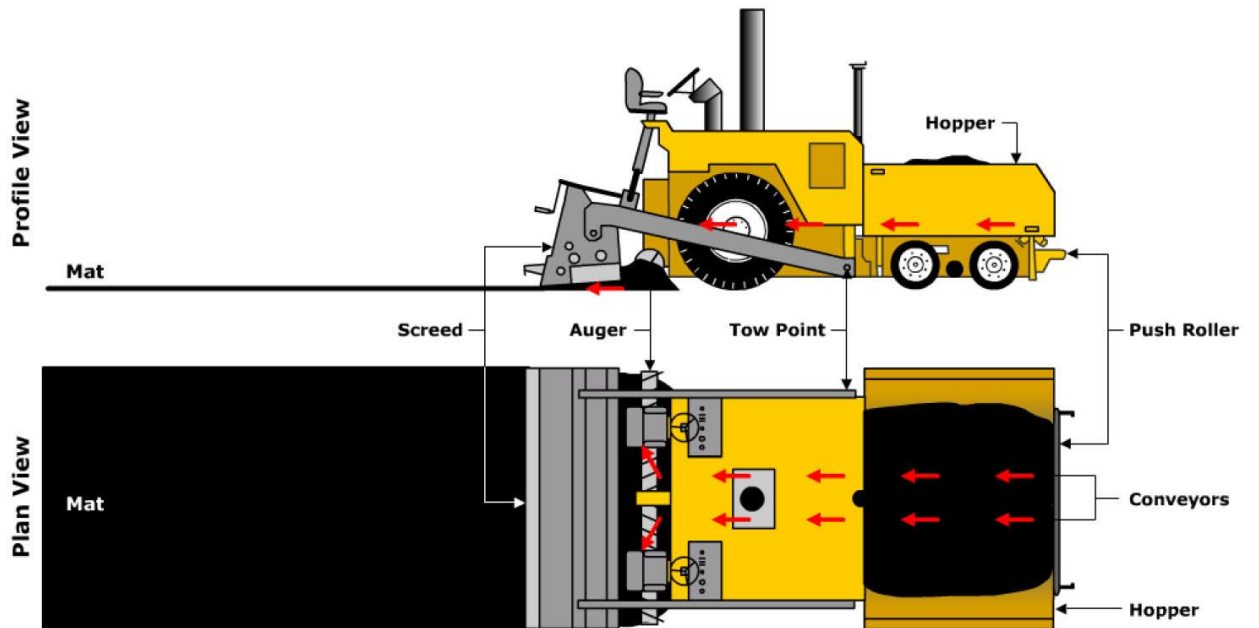

Figure 7. Asphalt that is cooler than about 175°F (79°C) is relatively stiff, and resists compaction, which results in a lower density than hotter areas after compaction, and is therefore prone to premature failure. Note the low-temperature spots in the thermograph, which are as cool as 153°F (67.2°C) and correlate with the visibly worn dark spots in the visual photo of the road after about a year of service. No MTV was used in the paving process.

Adoption of Paver based construction – to ensure even surface



Use of Smart Pavers System to Ensure Accurate Surface Profile



Paver with Sonic Levelling Device



Paver with GPS (3D Positioning) System

Adopting Innovative Pavement Management System



Channelized Traffic Causes Rutting Problems



Use of full rd can be ensured by shifting of marking



Use of Twin-Track system for Busway



Use of Rigid Pavement at Bus Stoppage



Use of Rigid Pavement at Waiting Area



Controlling Surface Drainage Problem by adopting Integrated Landuse Control



Controlling Overloading Problems



Maintaining Embankment Stability

Pavement Stresses

A. FLEXIBLE - PAVEMENT

Horizontal Shear Stress

The stresses that occur in a Hot Mix Asphalt (HMA) pavement under load are quite complex; routine calculation of these stresses is a recent development. Using a basic two-dimensional layered elastic model, the relationship between layer stiffness and stress for a two-layer flexible pavement structure is shown in Figure 1 below.

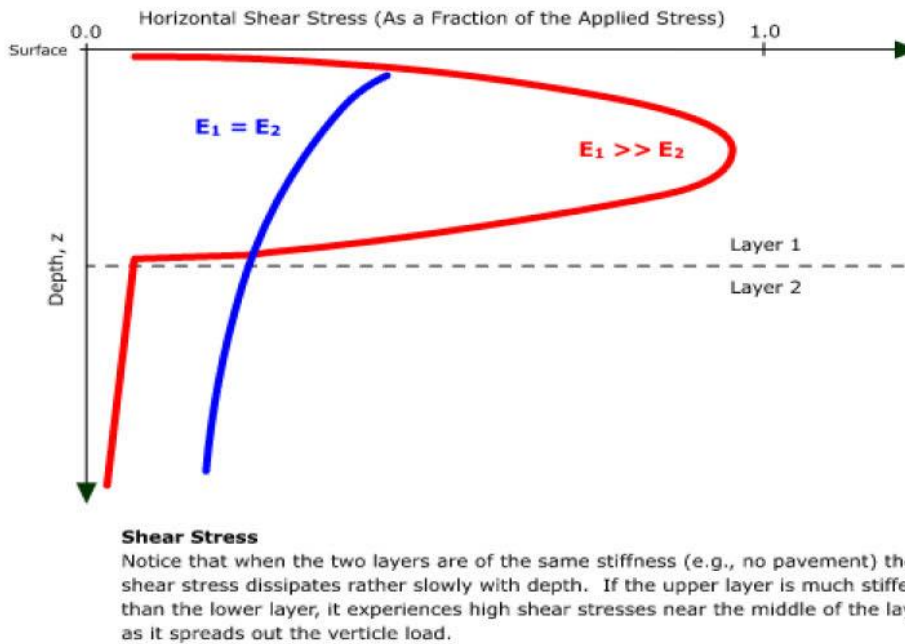

[View Vertical Stress](#) [View Horizontal Stress](#) [View Shear Stress](#)

Figure 1: Typical Two-Layer Flexible Pavement Stresses as Calculated by a Two-Dimensional Linear Elastic Model.

Deflection

HMA pavements are often described as "flexible" because they deflect under load. Figure 2 shows schematically how pavements deflect under load. Falling weight deflectometers (FWDs) can be used to accurately determine deflection characteristics of in-service pavements.

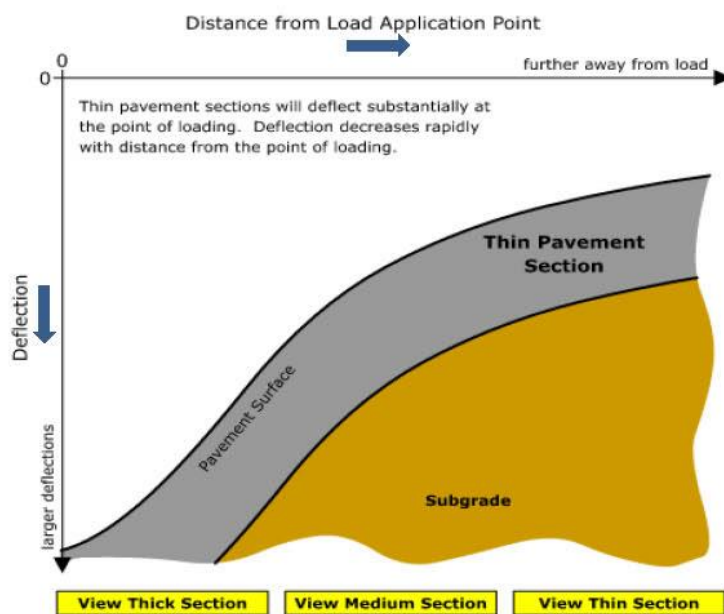
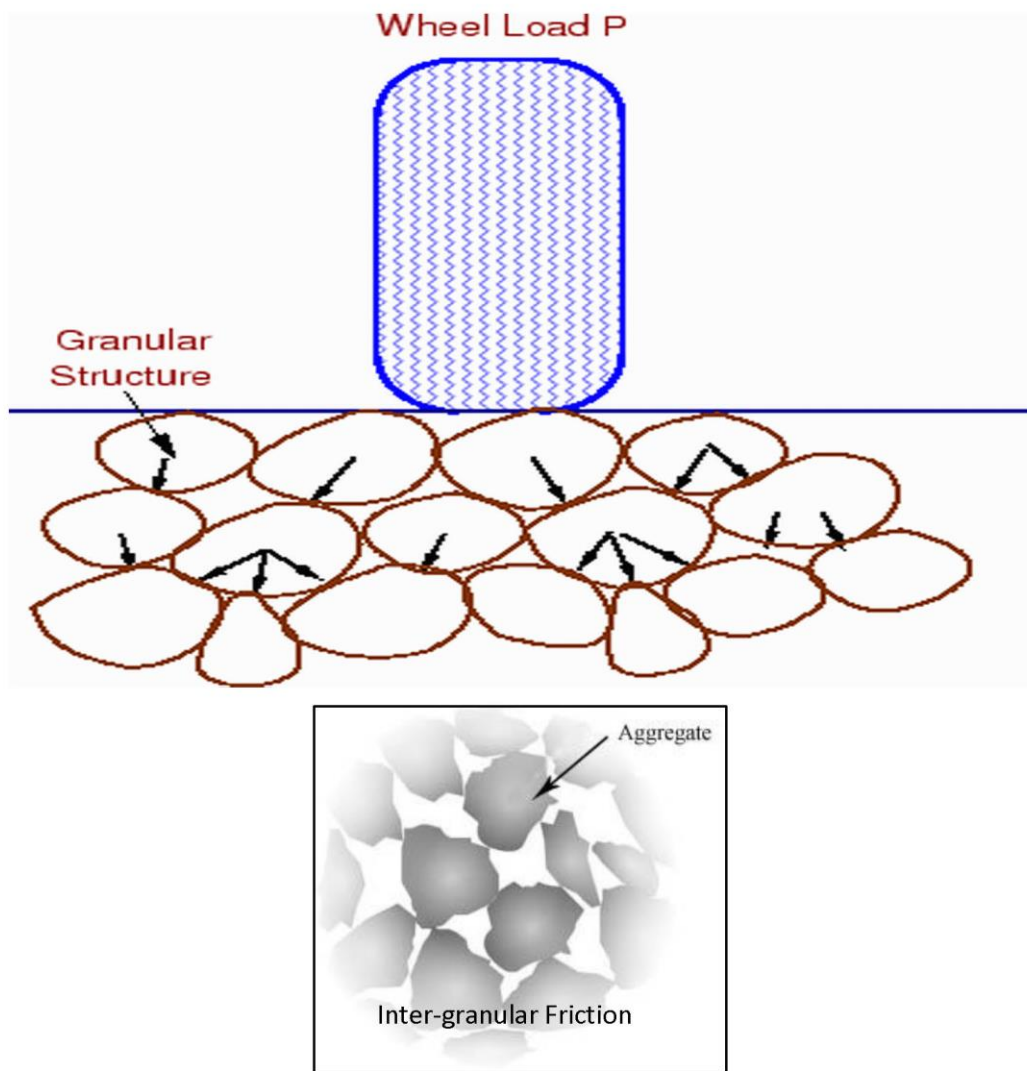
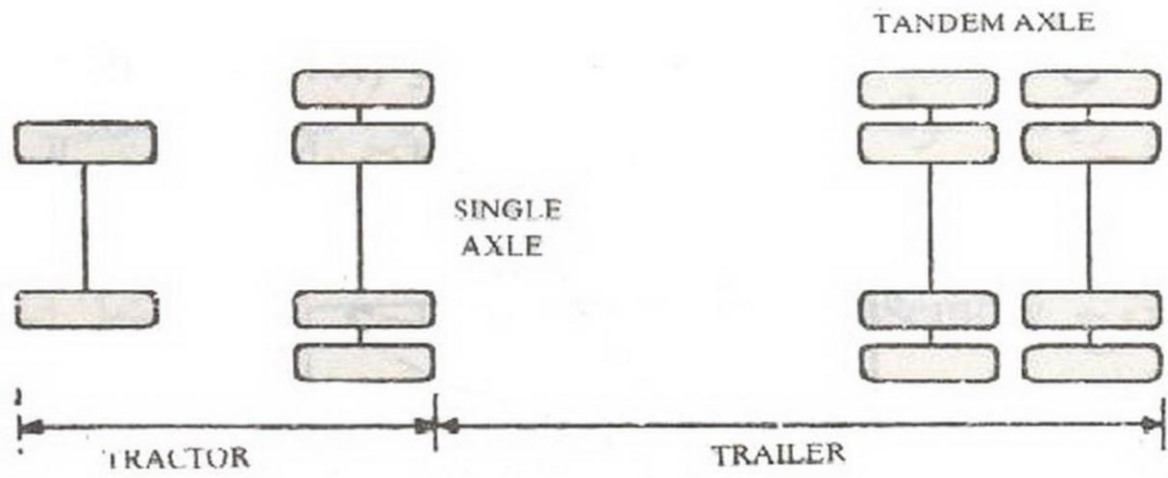
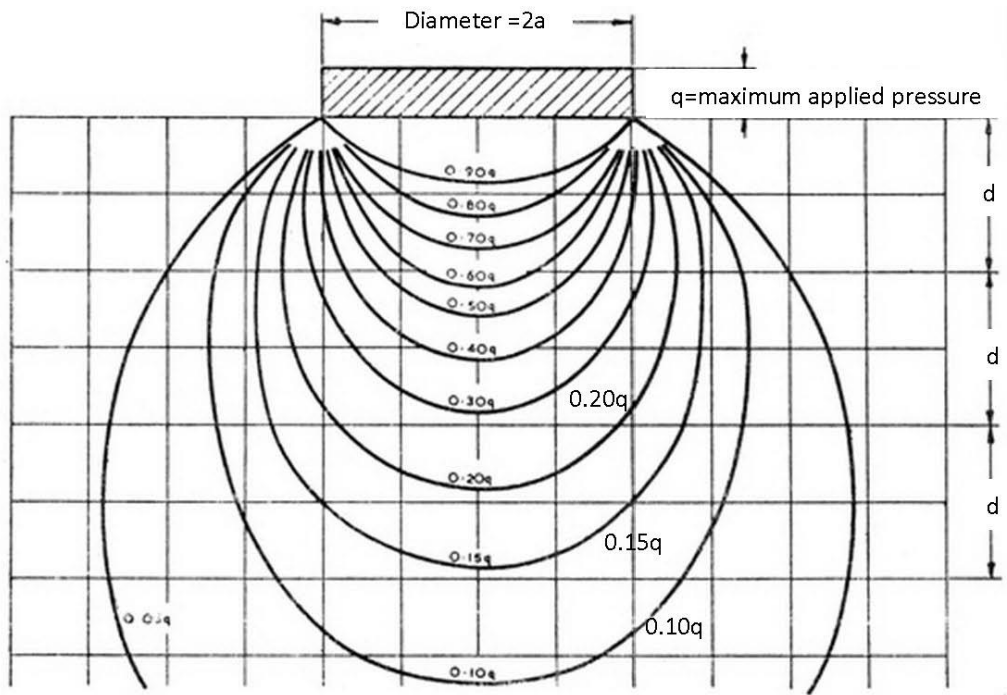

Figure 2: Schematic Showing Deflections for Different Pavement Thicknesses. The same HMA material characteristics are assumed for each graph - only the thickness varies.

[View Thick Section](#) [View Medium Section](#) [View Thin Section](#)





Bulb of Pressure under Uniform Circular Load

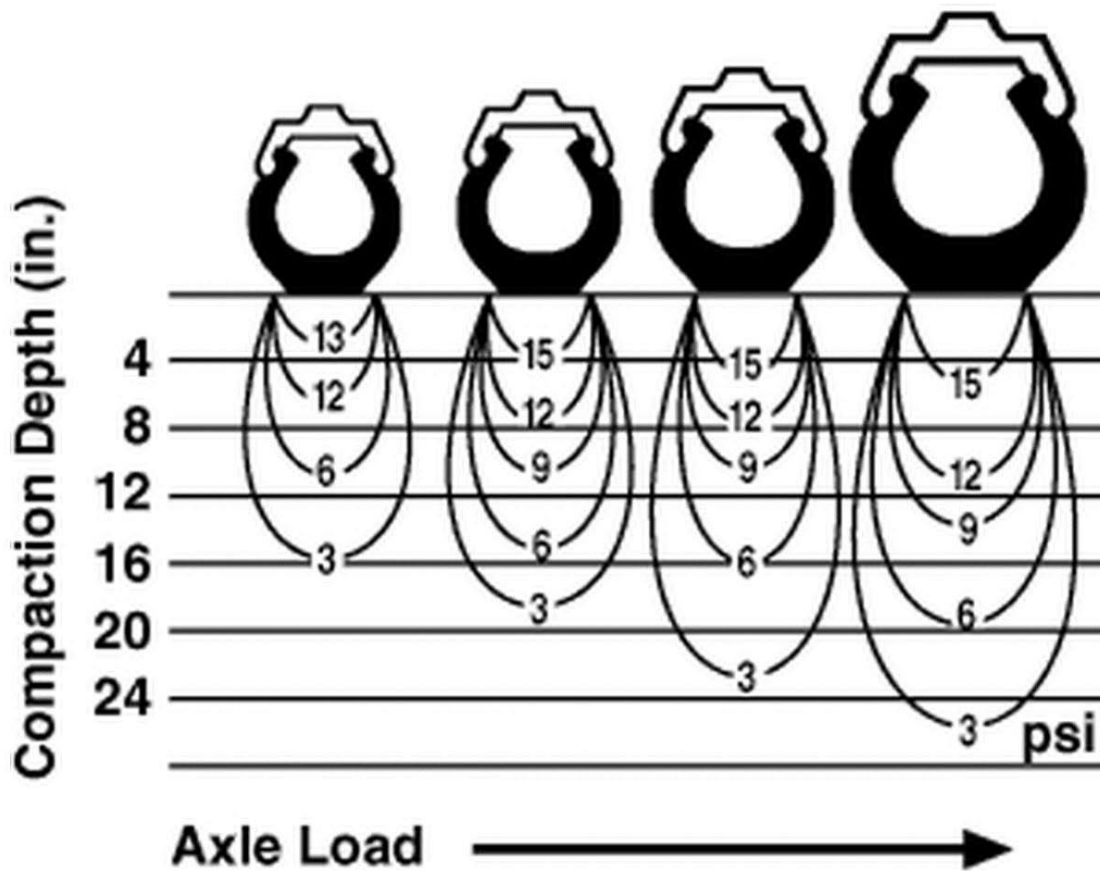

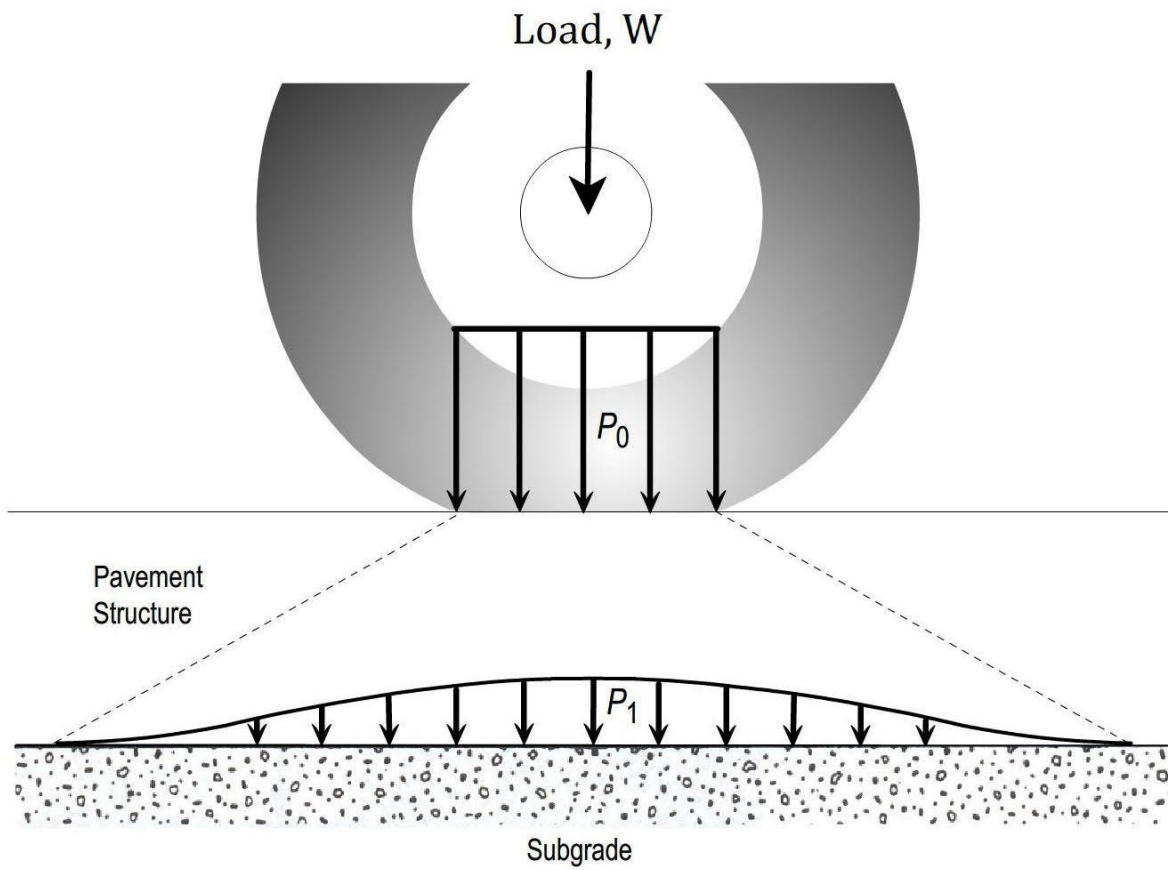

Spread of Wheel Load Pressure through Pavement Structure

(Source: The Asphalt Institute)

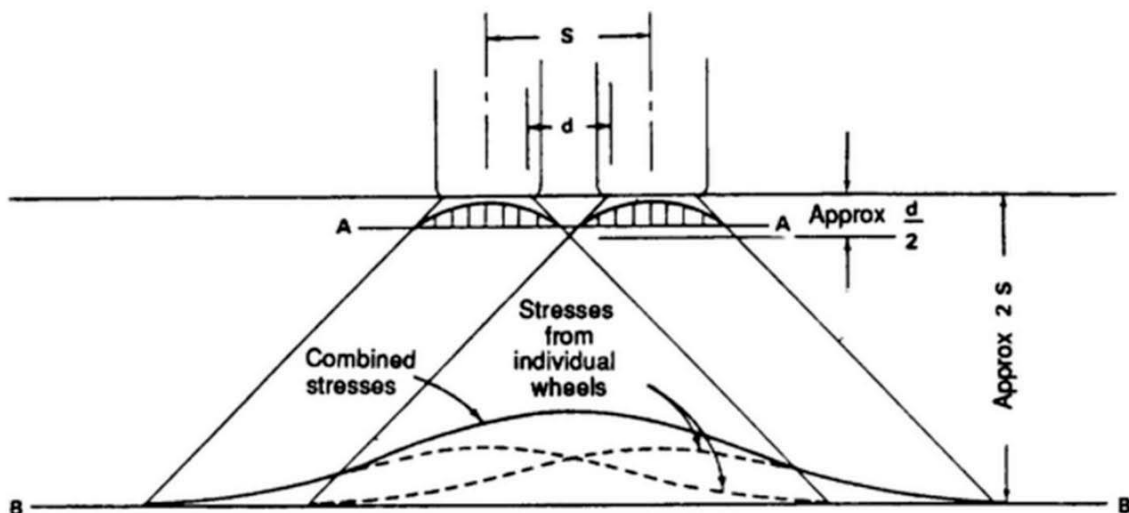

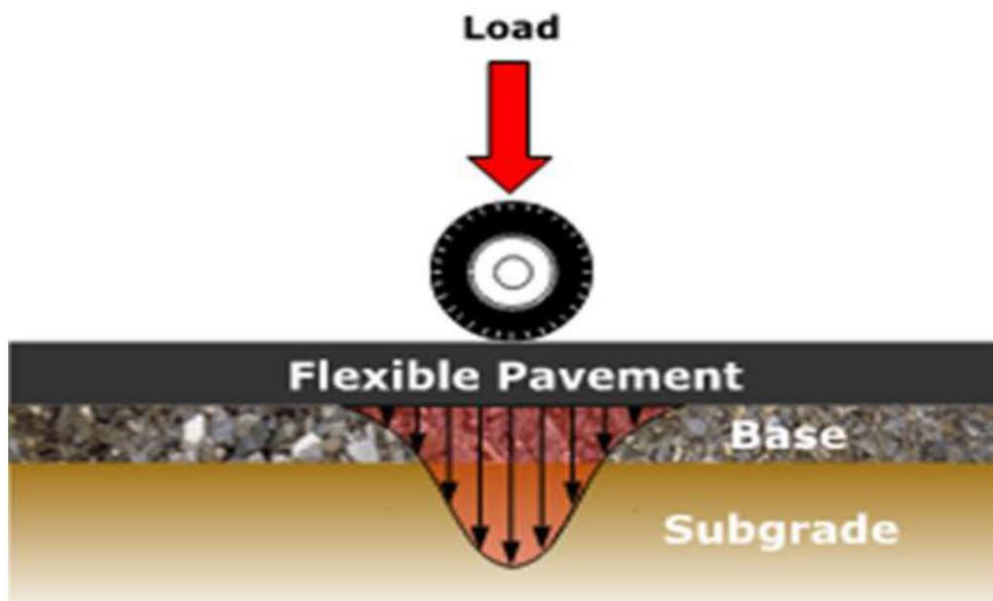
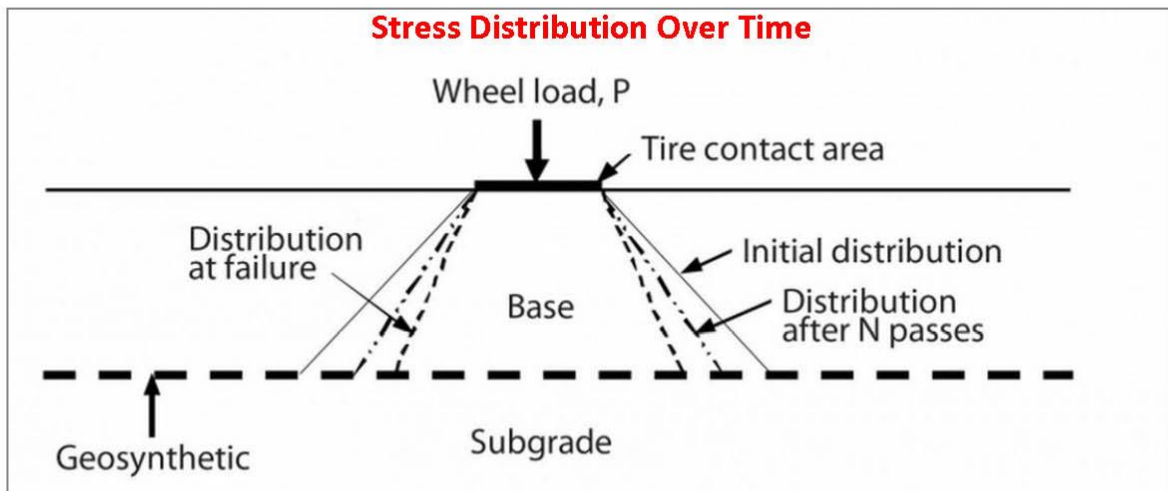
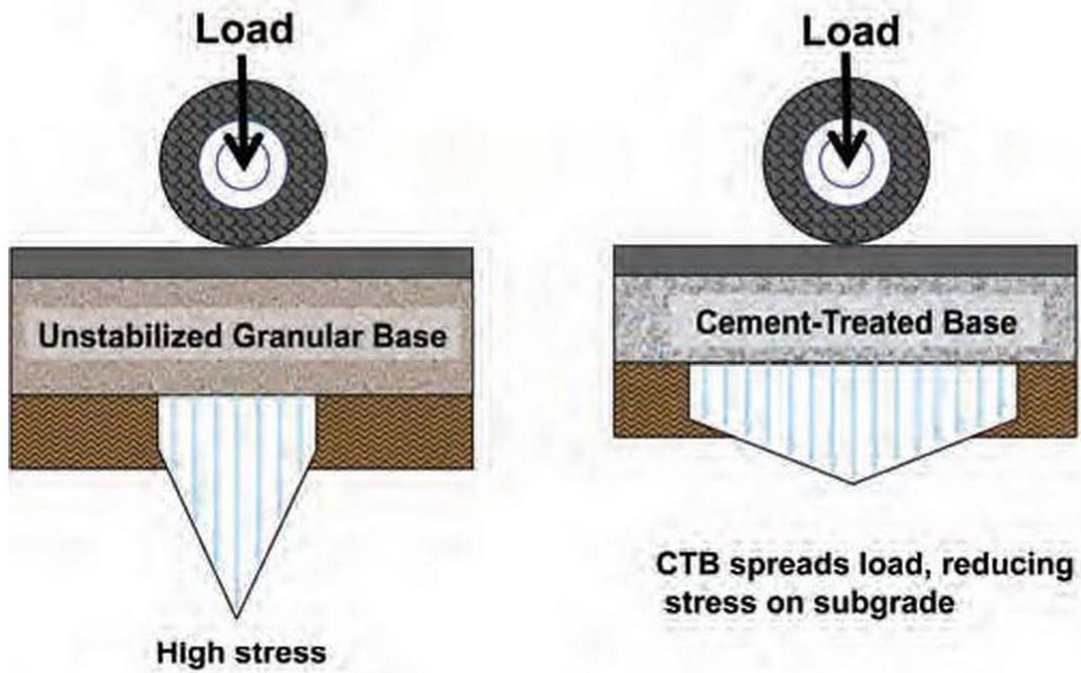

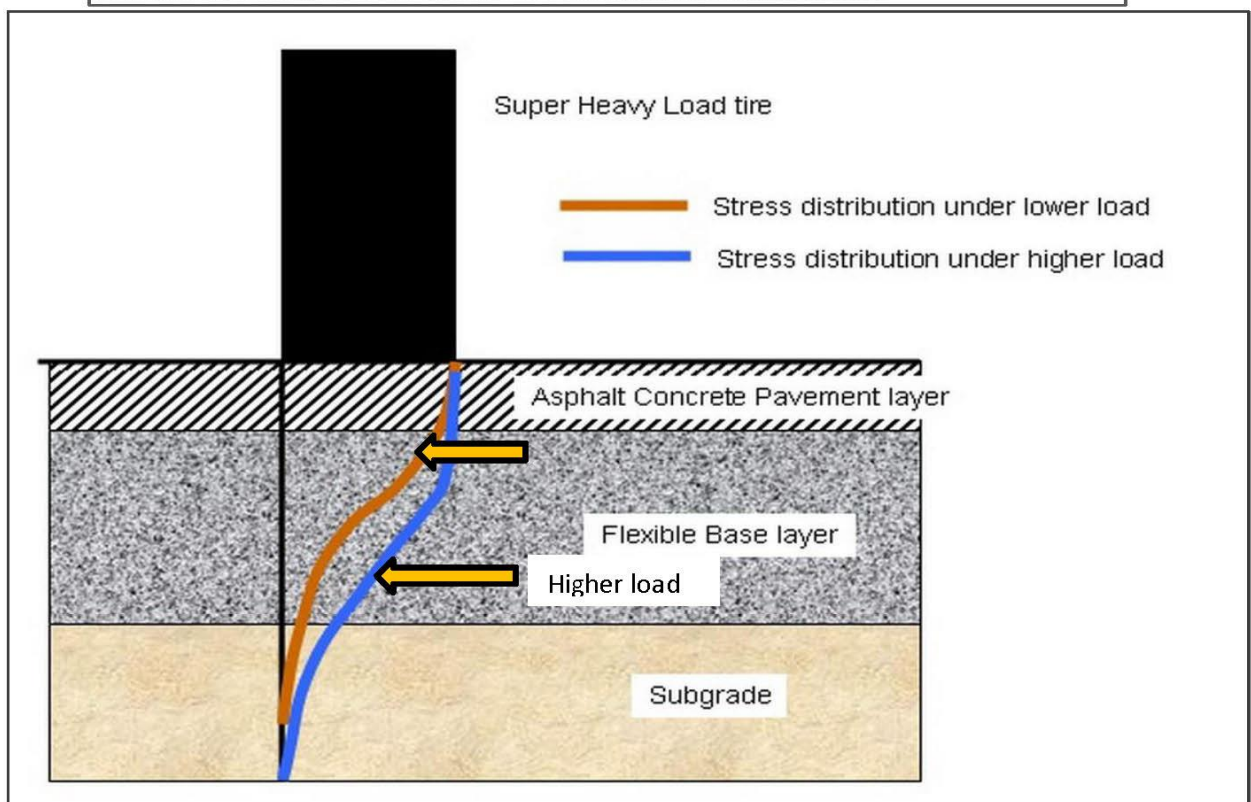
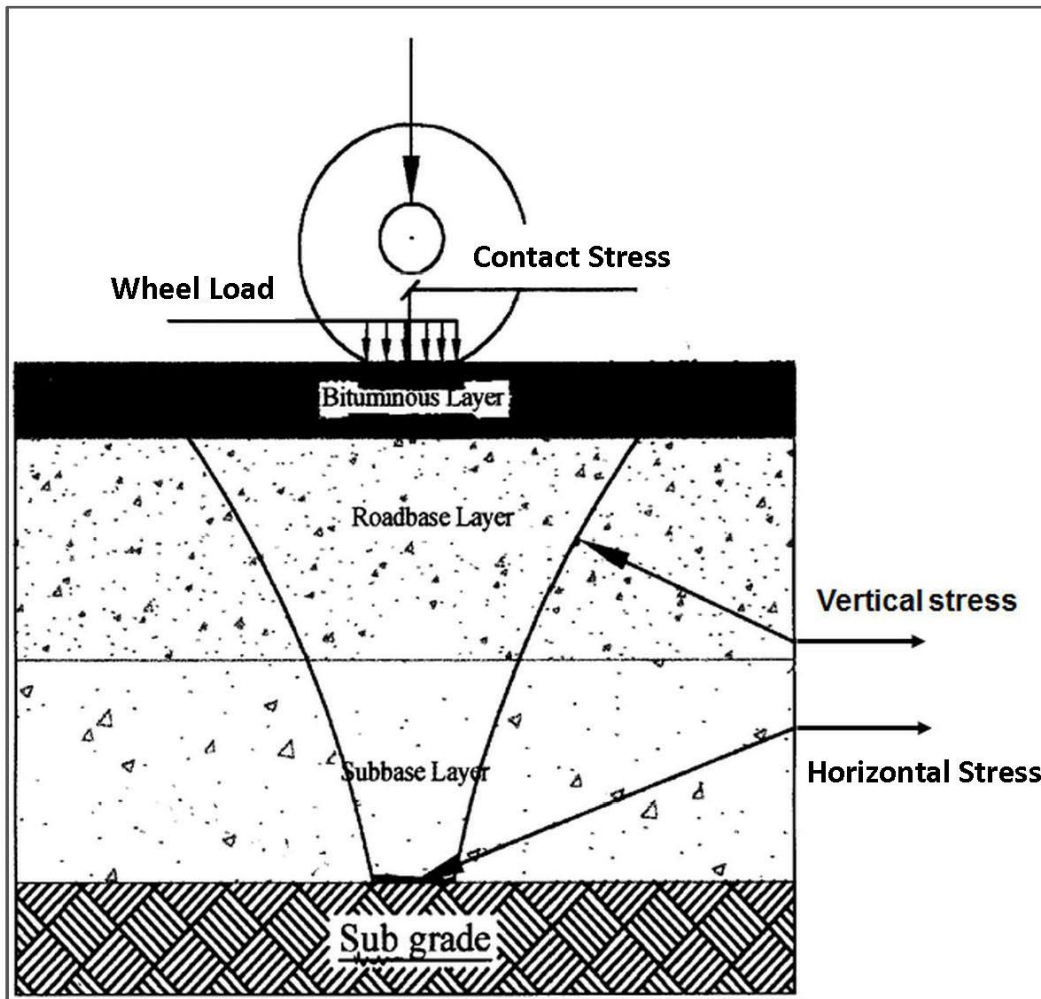

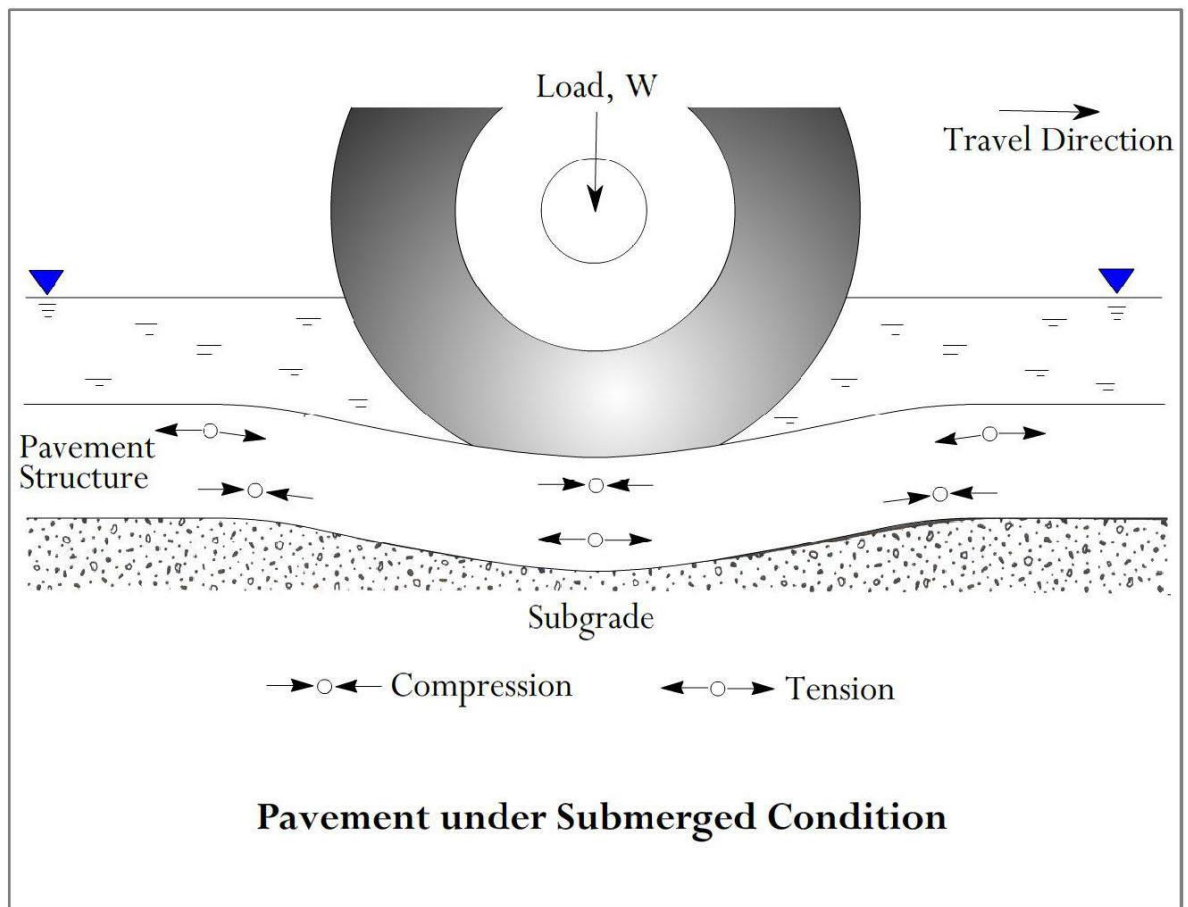
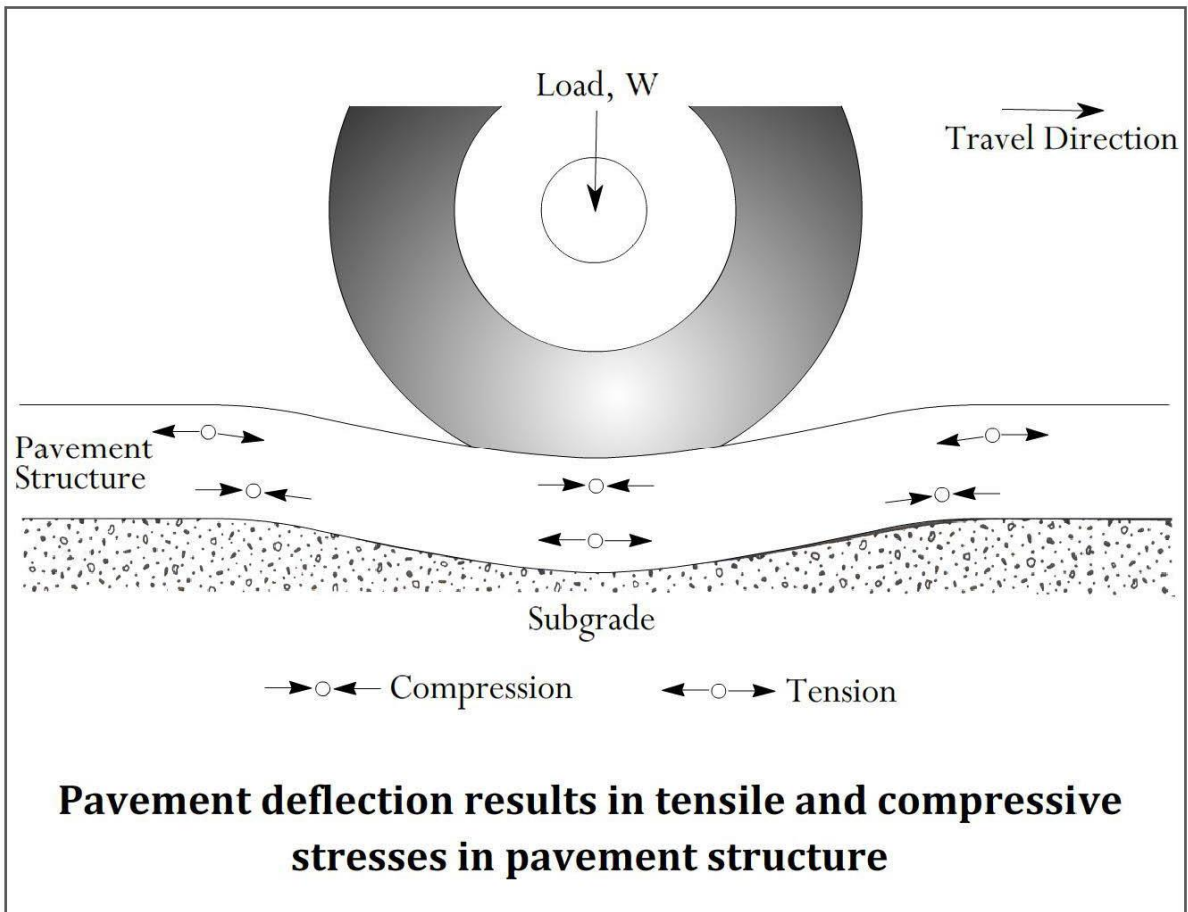

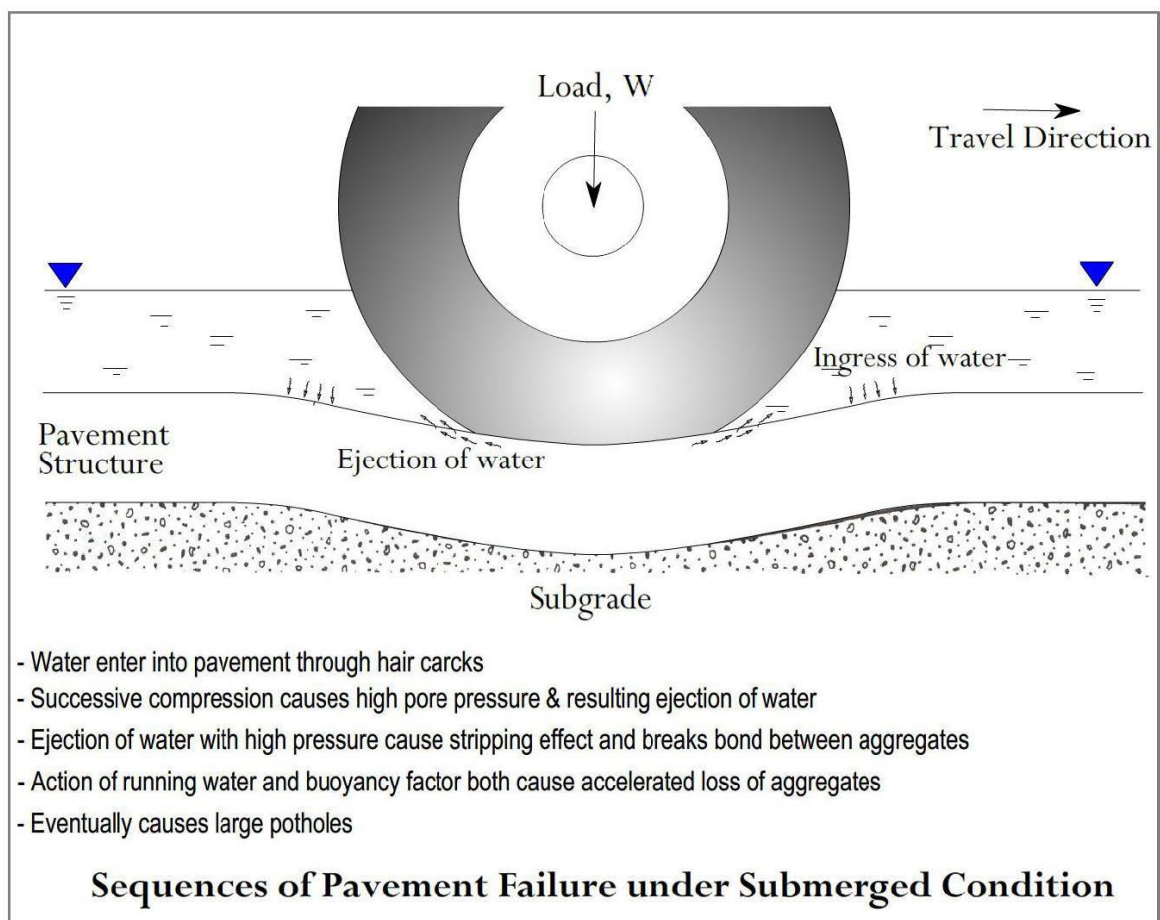
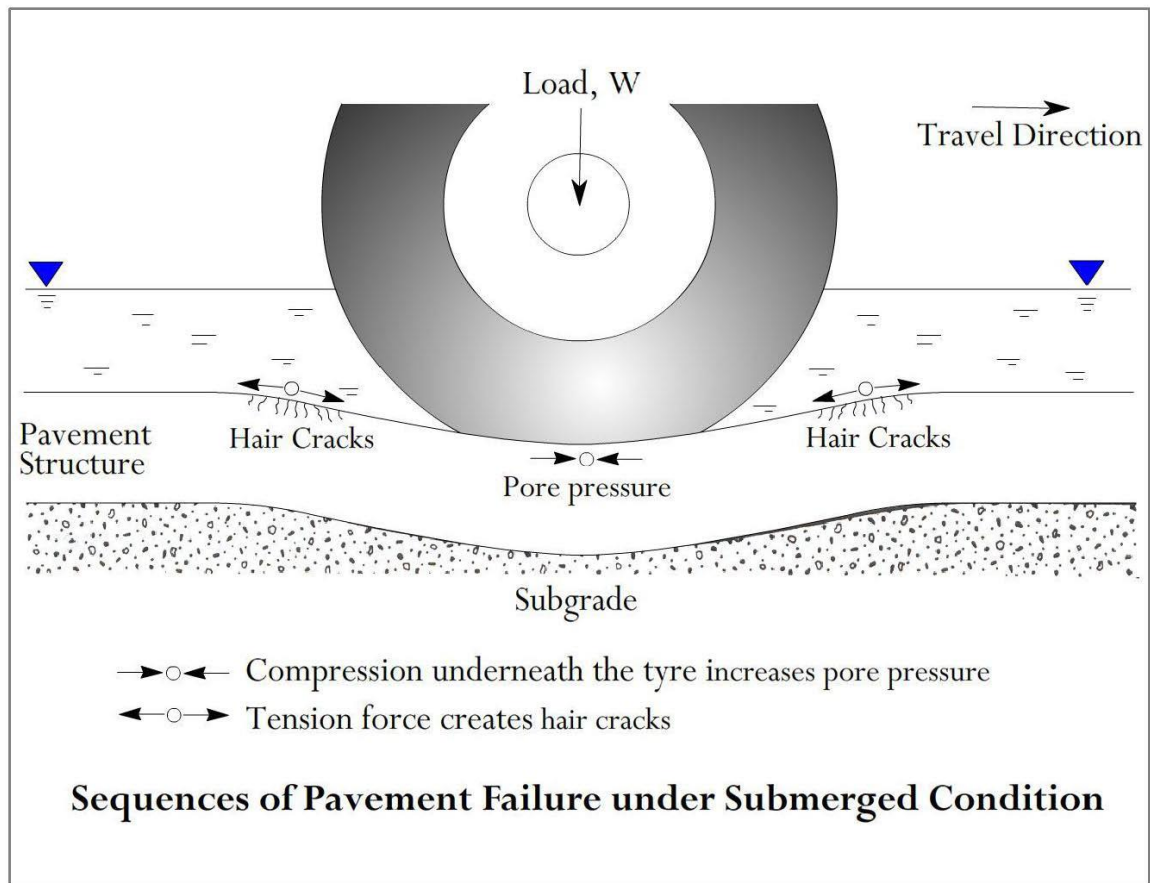



Suction force induced by action of running water and lifting force is produced by buoyancy factor



Successive compression & tension caused by moving of heavy vehicles

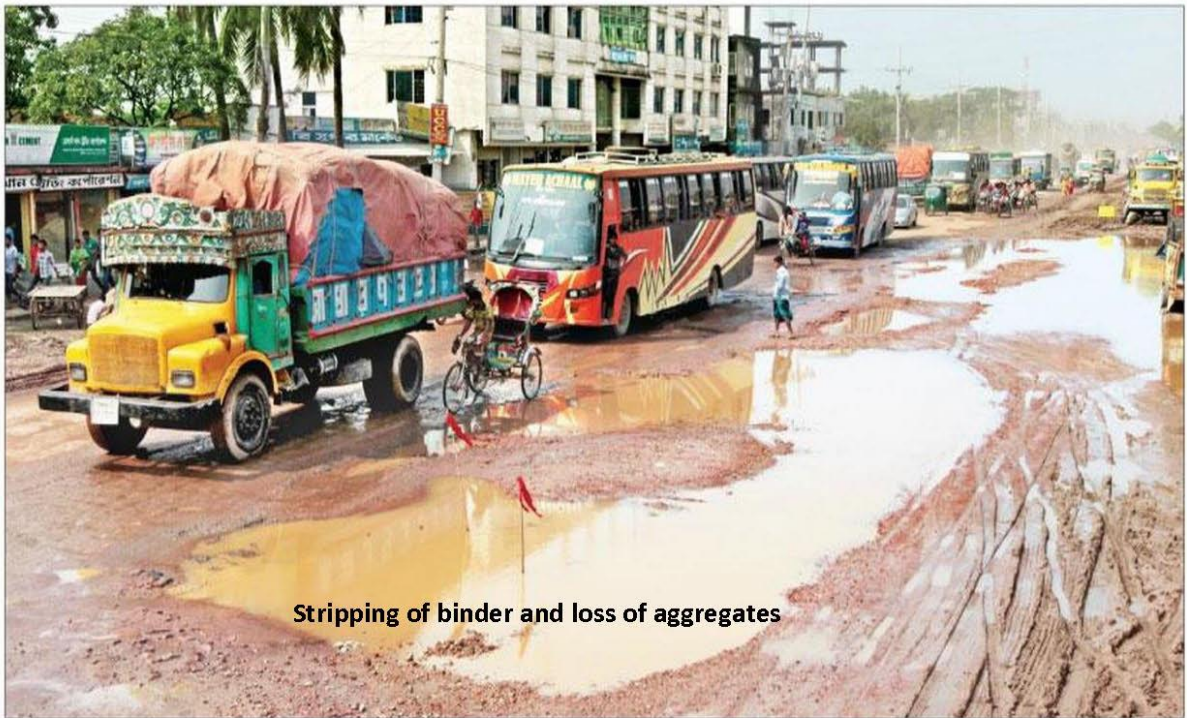

B. RIGID - PAVEMENT RESPONSE

Rigid pavements respond to loading in a variety of ways that affect performance (both initial and long-term). The three principal responses are:

- *Curling stress.* Differences in temperature between the top and bottom surfaces of a PCC slab will cause the slab to curl. Since slab weight and contact with the base restrict its movement, stresses are created.
- *Load stress.* Loads on a PCC slab will create both compressive and tensile stresses within the slab and any adjacent one (as long as load transfer efficiency is > 0).
- *Shrinkage/Expansion.* In addition to curling, environmental temperatures will cause PCC slabs to expand (when hot) and contract (when cool), which causes joint movement.

These three principal responses typically determine PCC slab geometry (typically described by slab thickness and joint design). As slabs get longer, wider and thinner, these responses, or a combination of them, will eventually exceed the slab's capacity and cause failure in the form of slab cracking, joint widening or blowup. Note that additional issues, notably load transfer stresses and deflections, must also be accounted for in design. There are a variety of ways to calculate or at least account for these responses in design. The empirical approach uses the AASHTO Road Test results to correlate measurable parameters (such as slab depth and PCC modulus of rupture) and derived indices (such as the load transfer coefficient and pavement serviceability index) to pavement performance. The mechanistic-empirical approach relates calculated pavement stresses to empirically derived failure conditions.

Stress

The stresses of primary concern are associated with slab bending either due to temperature gradients, loading or a combination thereof.

Curling

Since PCC is much stronger in compression than tension, tensile stresses tend to control PCC pavement design. Therefore, slab curling calculations seek to find the points of maximum tensile stress as the slab curls due to temperature gradients within (see the following Figure). In 1935, measurements reported by Teller and Southerland of the Bureau of Public Roads showed that the maximum temperature differential (hence, maximum curling and maximum tensile stresses) is much larger during the day than during the night. Therefore, the daytime curling stresses are usually most limiting.

Load

The original equations developed by Westergaard (1926) for three critical load locations will be presented. The critical load locations are (after Bradbury, 1938 and Westergaard, 1926):

1. *Interior loading.* Occurs when a load is applied on the interior of a slab surface which is "remote" from all edges.
2. *Edge loading.* Occurs when a load is applied on a slab edge "remote" from a slab corner.
3. *Corner loading.* Occurs when the center of a load is located on the bisector of the corner angle.

Assuming a poisson's ratio = 0.15, Westergaard's original equations are:

- Interior loading (tensile stress at the slab bottom)

$$\sigma_i = \frac{0.3162(W)}{h^2} \left[4 \log_{10} \left(\frac{l}{b} \right) + 1.069 \right]$$

- Edge loading (tensile stress at the slab bottom)

$$\sigma_e = \frac{0.572(W)}{h^2} \left[4 \log_{10} \left(\frac{l}{b} \right) + 0.359 \right]$$

- Corner loading (tensile stress at slab top)

$$\sigma_c = \frac{3(W)}{h^2} \left[1 - \left(\frac{a\sqrt{2}}{l} \right)^{0.6} \right]$$

where:

$\sigma_i, \sigma_e, \sigma_c$ = maximum stress (psi) for in interior, edge and corner loadings, respectively

W = wheel load (lbs.)

H = slab thickness (inches)

A = radius of wheel contact area (inches)

L = radius of relative stiffness (inches)

B = radius of resisting section (inches) = $\sqrt{1.6(a^2) + h^2} - 0.675(h)$

Note that all three equations involved the depth of slab (h) *squared*. This suggests that slab thickness is very critical in reducing load stresses to acceptable levels.

Shrinkage/Expansion

Although slab shrinkage and expansion causes internal stress, especially as the PCC sets and hardens, the long term concern centers on the joint movement that this shrinkage/expansion can cause. The following formula can be used to estimate joint movement in PCC slabs (FHWA, 1989):

$$z = (C)(L)[(e)(\Delta t) + \delta]$$

where:

- Z = joint opening = change in slab length (inches)
- C = base/slab frictional restraint factor
 - = 0.65 for stabilized bases
 - = 0.80 for granular bases
- L = slab length (inches)
- E = thermal coefficient of PCC (listed by coarse aggregate type)
 - = $6.6 \times 10^{-6}/^{\circ}\text{F}$ (quartz)
 - = $6.5 \times 10^{-6}/^{\circ}\text{F}$ (sandstone)
 - = $6.0 \times 10^{-6}/^{\circ}\text{F}$ (gravel)
 - = $5.3 \times 10^{-6}/^{\circ}\text{F}$ (granite)
 - = $4.8 \times 10^{-6}/^{\circ}\text{F}$ (basalt)
 - = $3.8 \times 10^{-6}/^{\circ}\text{F}$ (limestone)
- ΔT = the maximum temperature range (for some cases it is the temperature of the PCC at the time of placement minus the average daily minimum temperature in January) ($^{\circ}\text{F}$)
- Δ = shrinkage coefficient of PCC
 - ~ 0.0008 in./in. for indirect tensile strength of 300 psi or less
 - ~ 0.00045 in./in. for indirect tensile strength of 500 psi
 - ~ 0.0002 in./in. for indirect tensile strength of 700 psi or greater

(Note: δ should be omitted for rehabilitation projects as shrinkage (assuming no new slab PCC) is not a factor.)

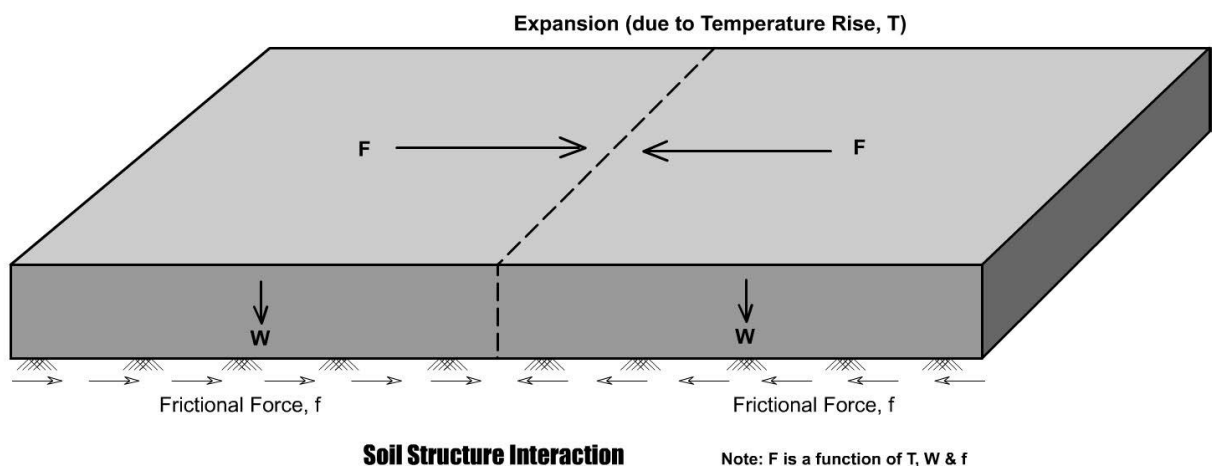
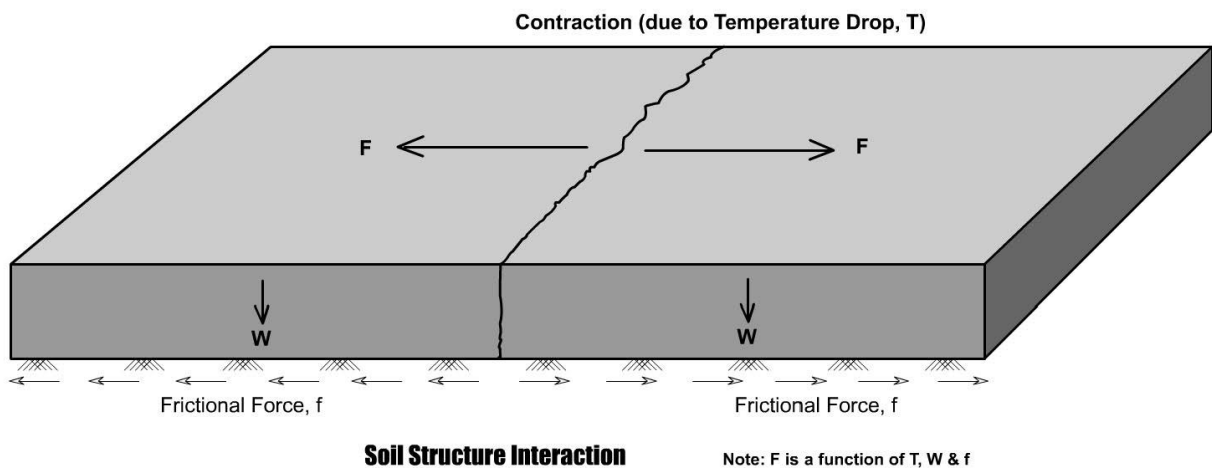

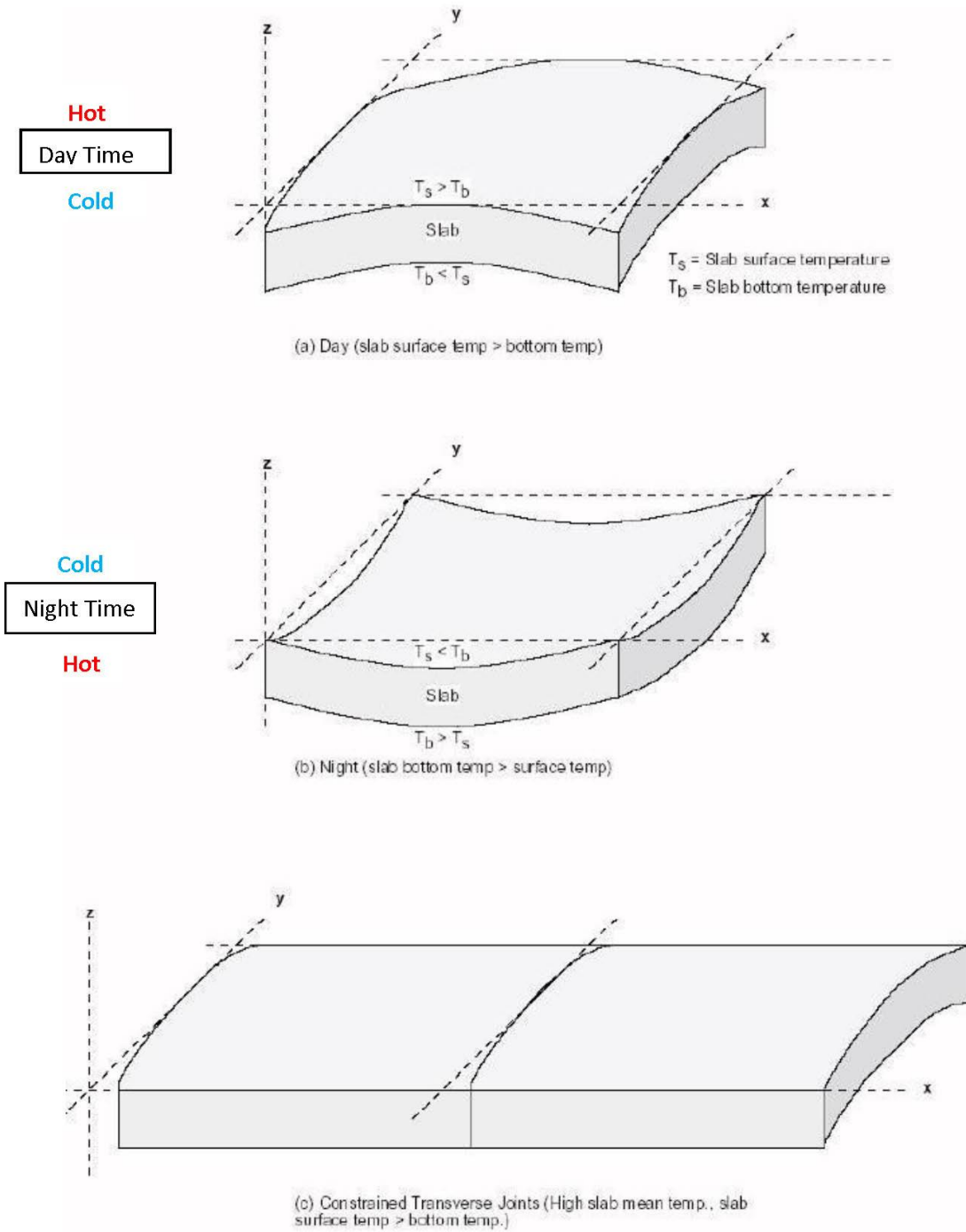
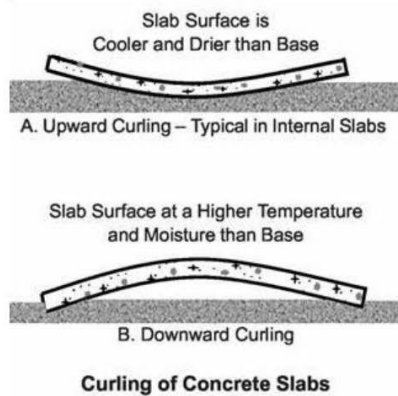
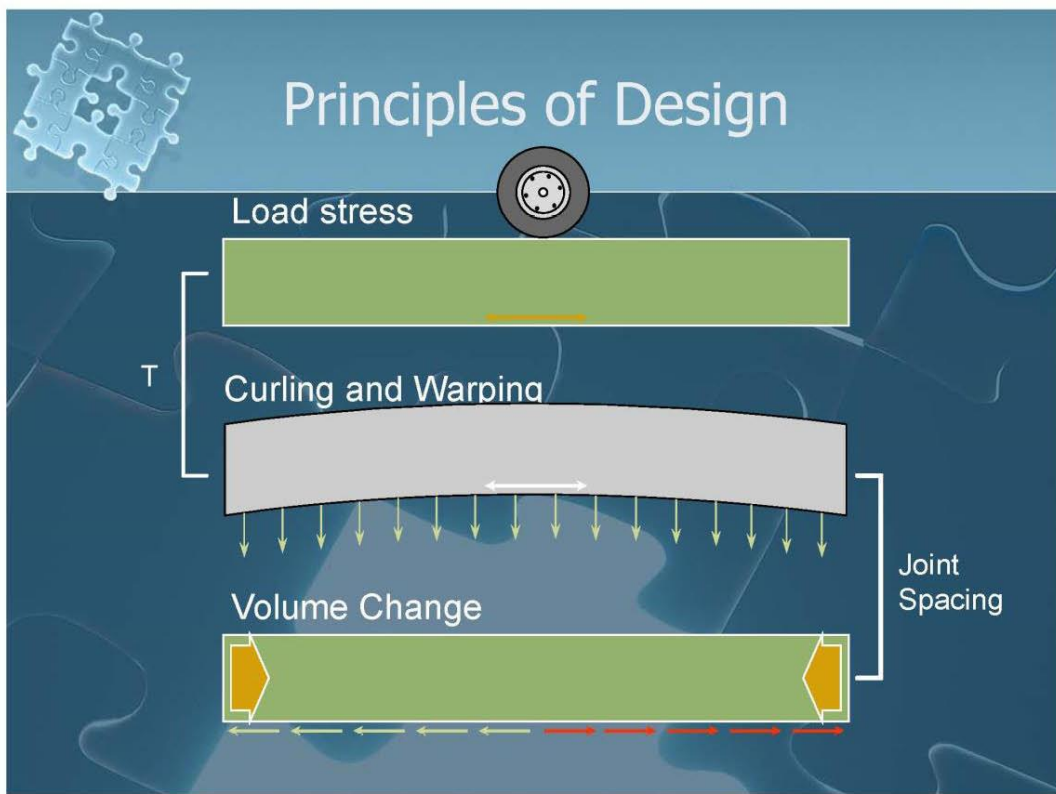
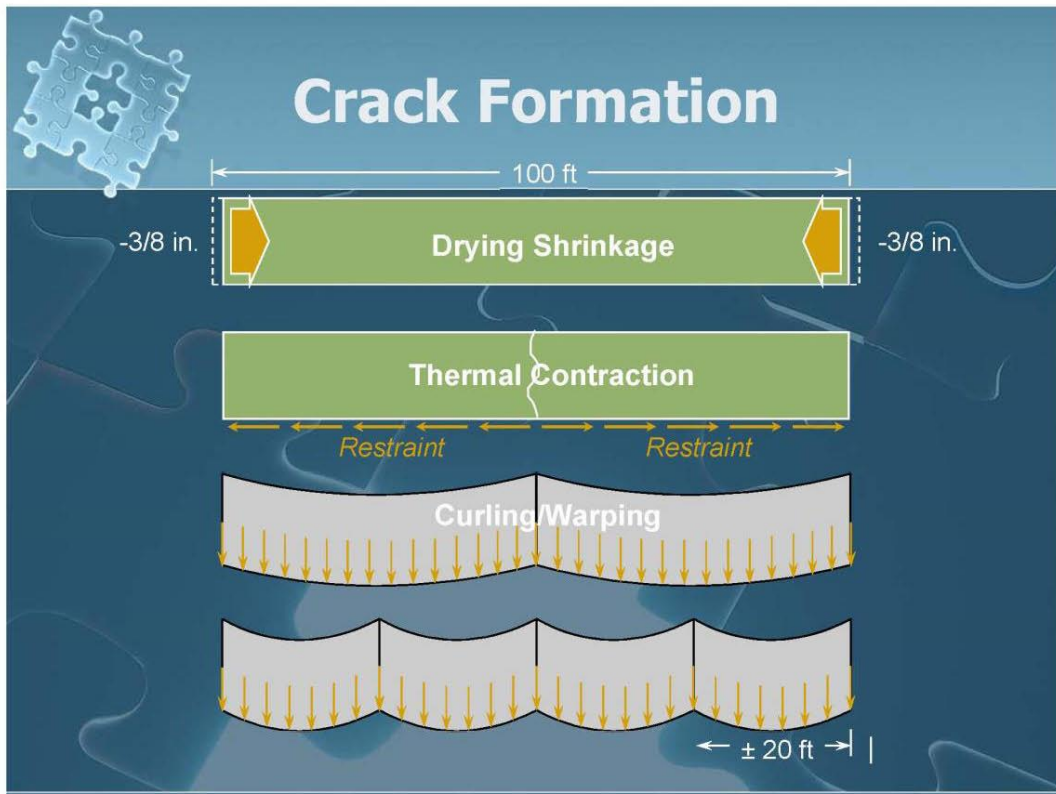

Figure: Slab Curling





Shrinkage (cycle)

Curling: caused by temperature gradient
Warping: caused by moisture gradient

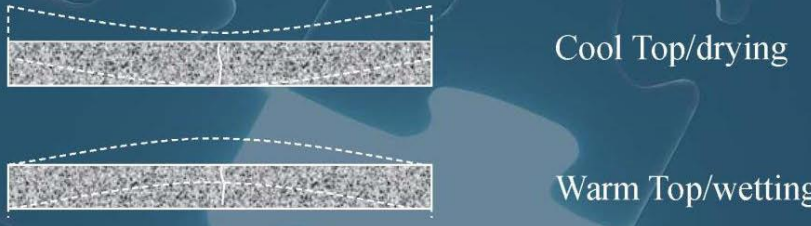

Cool Top/drying

Warm Top/wetting

What Causes Curling?

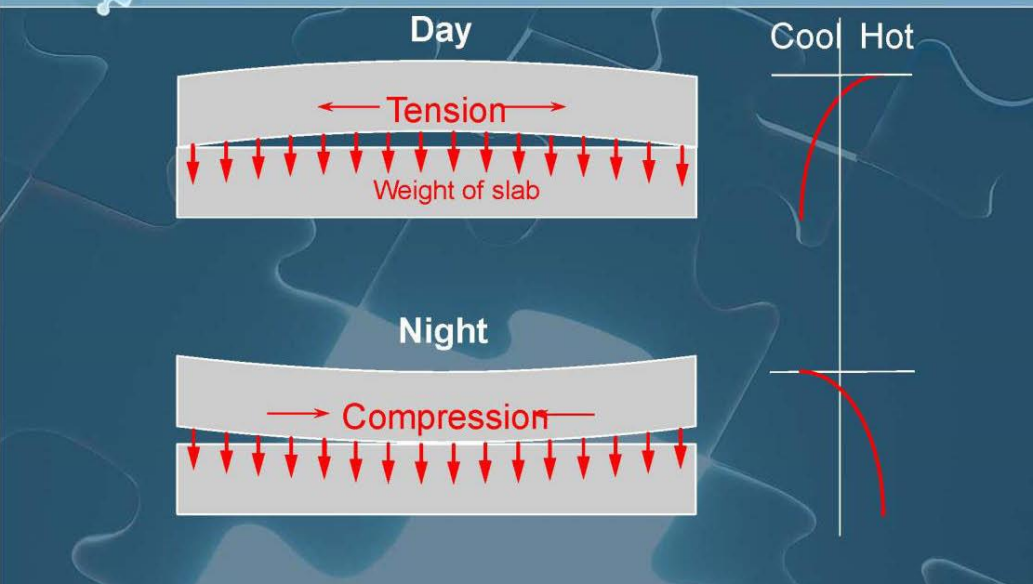

Day

Tension

Weight of slab

Night

Compression

Cool Hot

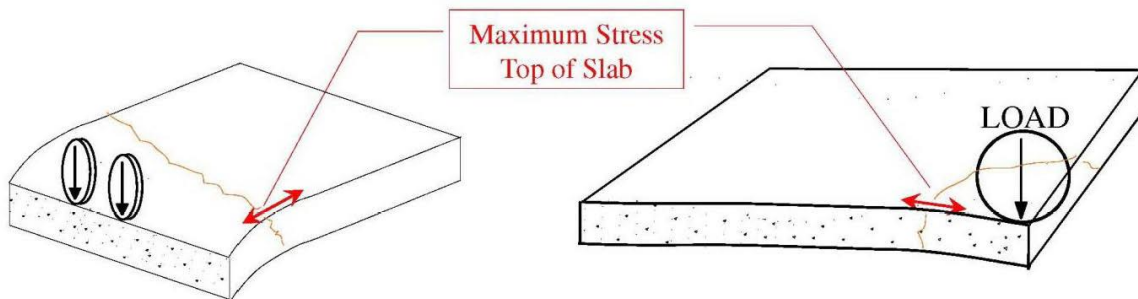
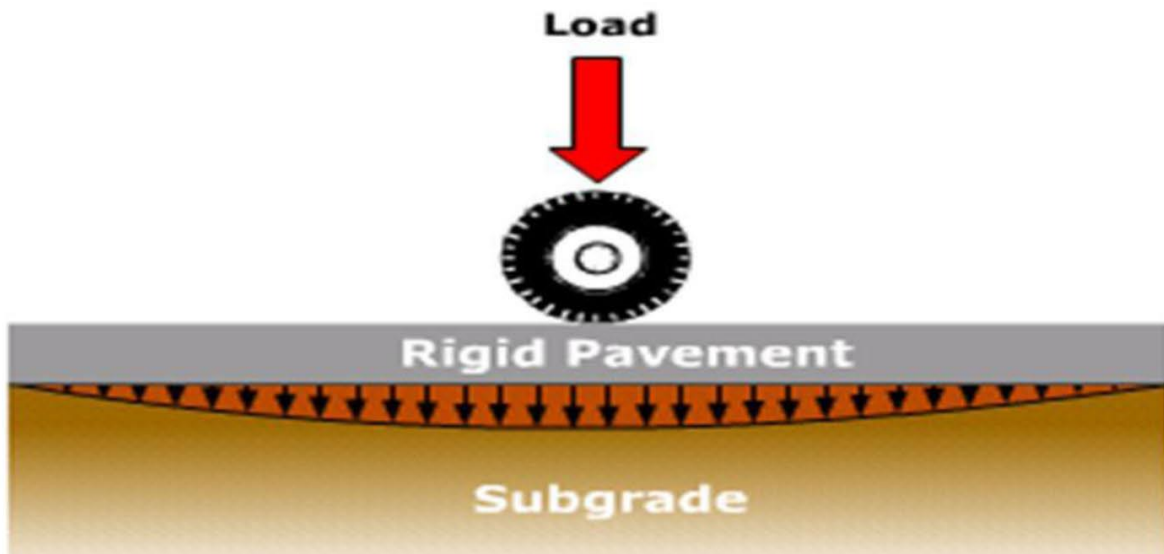



Pavement Distresses

FLEXIBLE PAVEMENT

Properly designed and maintained Hot Mix Asphalt (HMA) pavements can provide many years of satisfactory service. However, like all pavements, HMA pavements can be damaged by certain conditions. This section is a summary of the major flexible pavement distresses. Each distress discussion includes:

- Identifying basic HMA pavement damage
- Providing some insight into why particular surface distresses are problematic.
- Providing) typical causes of the distress.
- Suggest some basic repair strategies.

The most common pavement distresses in Bangladesh are low to moderate severity alligator (fatigue) cracking, ravelling and potholes. Mix stability problems like rutting, corrugation and shoving are also common.

Type of Pavement Distresses	
Fatigue (alligator) cracking	Polished aggregate
Bleeding	Potholes
Block cracking	Raveling
Corrugation and shoving	Rutting
Depression	Slippage cracking
Joint reflection cracking	Stripping
Longitudinal cracking	Transverse (thermal) cracking
Patching	Water bleeding and pumping

Fatigue (Alligator) Cracking



Bad fatigue cracking

Fatigue cracking from frost action

Fatigue cracking from edge failure

Description: Series of interconnected cracks caused by fatigue failure of the HMA surface (or stabilized base) under **repeated traffic loading**. In thin pavements, cracking initiates at the bottom of the HMA layer where the tensile stress is the highest then propagates to the surface as one or more longitudinal cracks (usually along the wheelpaths). This is commonly referred to as "**bottom-up**" or "**classical**" **fatigue cracking**. In thick pavements, the cracks most likely initiate from the top in areas of high localized tensile stresses resulting from tire-pavement interaction and asphalt **binder aging (top-down cracking)**. After repeated loading, the longitudinal cracks connect forming many-sided sharp-angled pieces that develop into a pattern resembling the back of an alligator or crocodile.

Problem: Increase roughness (loss riding quality), indicator of structural failure, cracks allow moisture infiltration, eventually results in potholes and pavement disintegration if not treated.

Possible Causes: Inadequate structural support, which can be caused by a myriad of things. A few of the more common ones are listed here:

- Decrease in pavement load supporting characteristics
 - Loss of base, subbase or subgrade support (e.g., poor drainage or spring thaw resulting in a less stiff base).
 - Stripping on the bottom of the HMA layer (the stripped portion contributes little to pavement strength so the effective HMA thickness decreases)

- Increase in loading (e.g., more or heavier loads than anticipated in design)
- Inadequate structural design
- Poor construction (e.g., inadequate compaction)

Repair: A fatigue cracked pavement should be investigated to determine the root cause of failure. Any investigation should involve digging a pit or coring the pavement to determine the pavement's structural makeup as well as determining whether or not subsurface moisture is a contributing factor. Once the characteristic alligator pattern is apparent, repair by crack sealing is generally ineffective. Fatigue crack repair generally falls into one of two categories:

- *Small, localized fatigue cracking indicative of a loss of subgrade support.* Remove the cracked pavement area then dig out and replace the area of poor subgrade and improve the drainage of that area if necessary. Patch over the repaired subgrade.
- *Large fatigue cracked areas indicative of general structural failure.* Place an HMA overlay over the entire pavement surface. This overlay must be strong enough structurally to carry the anticipated loading because the underlying fatigue cracked pavement most likely contributes little or no strength.

Bleeding



BST bleeding in wheel paths



BST bleeding in wheel paths



HMA bleeding from over-asphalting

Description: A film of asphalt binder on the pavement surface. It usually creates a shiny, glass-like reflecting surface (as in the third photo) that can become quite sticky.

Problem: Loss of skid resistance when wet and make loss on vehicle control in summer due to lack of tractive force.

Possible Causes: Bleeding occurs when asphalt binder fills the aggregate voids during hot weather and then expands onto the pavement surface. Since bleeding is not reversible during cold weather, asphalt binder will accumulate on the pavement surface over time. This can be caused by one or a combination of the following:

- Excessive asphalt binder in the HMA (either due to mix design or manufacturing)
- Excessive application of asphalt binder during BST application (as in the above figures)
- Low HMA air void content (e.g., not enough room for the asphalt to expand into during hot weather)

Repair: The following repair measures may eliminate or reduce the asphalt binder film on the pavement's surface but may not correct the underlying problem that caused the bleeding:

- Minor bleeding can often be corrected by applying coarse sand to blot up the excess asphalt binder.
- Major bleeding can be corrected by cutting off excess asphalt with a motor grader or removing it with a heater planer. If the resulting surface is excessively rough, resurfacing may be necessary.

Block Cracking

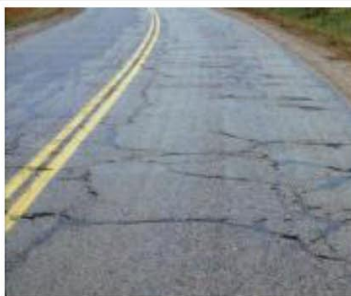

Description: Interconnected cracks that divide the pavement up into rectangular pieces. Blocks range in size from approximately 0.1m^2 (1ft^2) to 9m^2 (100ft^2). Larger blocks are generally classified as longitudinal and transverse cracking. Block cracking normally occurs over a large portion of pavement area but sometimes will occur only in non-traffic areas.

Problem: Allows moisture infiltration, roughness

Possible Causes: HMA shrinkage and daily temperature cycling. Typically caused by an inability of asphalt binder to expand and contract with temperature cycles because of:

- Asphalt binder aging
- Poor choice of asphalt binder in the mix design

Repair: Strategies depend upon the severity and extent of the block cracking:

- *Low severity cracks (< 1/2 inch wide).* Crack seal to prevent (1) entry of moisture into the subgrade through the cracks and (2) further raveling of the crack edges. HMA can provide years of satisfactory service after developing small cracks if they are kept sealed.
- *High severity cracks (> 1/2 inch wide and cracks with raveled edges).* Remove and replace the cracked pavement layer with an overlay.

Corrugation and Shoving



Description: A form of plastic movement typified by ripples (corrugation) or an abrupt wave (shoving) across the pavement surface. The distortion is perpendicular to the traffic direction. Usually occurs at points where traffic starts and stops (corrugation) or areas where HMA abuts a rigid object (shoving).

Problem: Roughness

Possible Causes: Usually caused by traffic action (starting and stopping) combined with:

- An unstable (i.e. low stiffness) HMA layer (caused by mix contamination, poor mix design, poor HMA manufacturing, or lack of aeration of liquid asphalt emulsions)
- Excessive moisture in the subgrade

Repair: A heavily corrugated or shoved pavement should be investigated to determine the root cause of failure. Repair strategies generally fall into one of two categories:

- *Small, localized areas of corrugation or shoving.* Remove the distorted pavement and patch.
- *Large corrugated or shoved areas indicative of general HMA failure.* Remove the damaged pavement and overlay.

Depression



Depression in left lane and shoulder

Depression in the middle

Local Ponding on Depression

Description: Localized pavement surface areas with slightly lower elevations than the surrounding pavement. Depressions are very noticeable after a rain when they fill with water.

Problem: Roughness, depressions filled with substantial water can cause vehicle hydroplaning

Possible Causes: Frost heave or subgrade settlement resulting from inadequate compaction during construction.

Repair: By definition, depressions are small localized areas. A pavement depression should be investigated to determine the root cause of failure (i.e., subgrade settlement or frost heave). Depressions should be repaired by removing the affected pavement then digging out and replacing the area of poor subgrade. Patch over the repaired subgrade.

Joint Reflection Cracking



Joint reflection cracking on an arterial

Joint reflection cracking on an arterial

Joint reflection cracking close-up

Description: Cracks in a flexible overlay of a rigid pavement. The cracks occur directly over the underlying rigid pavement joints. Joint reflection cracking does not include reflection cracks that occur away from an underlying joint or from any other type of base (e.g., cement or lime stabilized).

Problem: Allows moisture infiltration, roughness

Possible Causes: Movement of the PCC slab beneath the HMA surface because of thermal and moisture changes. Generally not load initiated, however loading can hasten deterioration.

Repair: Strategies depend upon the severity and extent of the cracking:

- *Low severity cracks (< 1/2 inch wide and infrequent cracks).* Crack seal to prevent (1) entry of moisture into the subgrade through the cracks and (2) further raveling of the crack edges. In general, rigid pavement joints will eventually reflect through an HMA overlay without proper surface preparation.
- *High severity cracks (> 1/2 inch wide and numerous cracks).* Remove and replace the cracked pavement layer with an overlay.

Longitudinal Cracking



Longitudinal cracking as the onset of fatigue cracking

Longitudinal cracking from poor joint construction

Description: Cracks parallel to the pavement's centerline or laydown direction. Usually a type of fatigue cracking.

Problem: Allows moisture infiltration, roughness, indicates possible onset of alligator cracking and structural failure.

Possible Causes:

- Poor joint construction Joints are generally the **least dense** areas of a pavement. Therefore, they should be constructed outside of the wheel path so that they are only infrequently loaded. Joints in the wheel path like those shown in third through fifth figures above, will general fail prematurely.
- A reflective crack from an underlying layer (not including joint reflection cracking)
- HMA fatigue (indicates the onset of future alligator cracking)
- Top-down cracking

Repair: Strategies depend upon the severity and extent of the cracking:

- *Low severity cracks (< 1/2 inch wide and infrequent cracks).* Crack seal to prevent (1) entry of moisture into the subgrade through the cracks and (2) further raveling of the crack edges. HMA can provide years of satisfactory service after developing small cracks if they are kept sealed.
- *High severity cracks (> 1/2 inch wide and numerous cracks).* Remove and replace the cracked pavement layer with an overlay.

Patching

Failing patch

Patch over localized distress

Utility cut patch

Description: An area of pavement that has been replaced with new material to repair the existing pavement. A patch is considered a defect no matter how well it performs.

Problem: Roughness

Possible Causes:

- Previous localized pavement deterioration that has been removed and patched
- Utility cuts

Repair: Patches are themselves a repair action. The only way they can be removed from a pavement's surface is by either a structural or non-structural overlay.

Polished Aggregate

SMAs at the NCAT test track

5 years of wear

Polished Surface

Description: Areas of HMA pavement where the portion of aggregate extending above the asphalt binder is either very small or there are no rough or angular aggregate particles.

Problem: Decreased skid resistance

Possible Causes: Repeated traffic applications. Generally, as a pavement ages the protruding rough, angular particles become polished. This can occur quicker if the aggregate is susceptible to abrasion or subject to excessive studded tire wear.

Repair: Apply a skid-resistant slurry seal or BST or overlay.

Potholes



Pothole from fatigue cracking



Developing pothole



Large Pothole

Description: Small, bowl-shaped depressions in the pavement surface that penetrate all the way through the HMA layer down to the base course. They generally have sharp edges and vertical sides near the top of the hole. Potholes are most likely to occur on roads with thin HMA surfaces (25 to 50 mm (1 to 2 inches)) and seldom occur on roads with 100 mm (4 inch) or deeper HMA surfaces.

Problem: Roughness (serious vehicular damage can result from driving across potholes at higher speeds), moisture infiltration

Possible Causes: Generally, potholes are the end result of alligator cracking. As alligator cracking becomes severe, the interconnected cracks create small chunks of pavement, which can be dislodged as vehicles drive over them. The remaining hole after the pavement chunk is dislodged is called a pothole.

Repair: In accordance with patching techniques.

Raveling



Raveling due to low density



Raveling from snowplow operations



From segregation

Description: The progressive disintegration of an HMA layer from the surface downward as a result of the dislodgement of aggregate particles.

Problem: Loose debris on the pavement, roughness, water collecting in the ravelled locations resulting in vehicle hydroplaning, loss of skid resistance

Possible Causes: Several including:

- Loss of bond between aggregate particles and the asphalt binder as a result of:
 - A dust coating on the aggregate particles that forces the asphalt binder to bond with the dust rather than the aggregate
 - Aggregate Segregation. If fine particles are missing from the aggregate matrix, then the asphalt binder is only able to bind the remaining coarse particles at their relatively few contact points.

- Inadequate compaction during construction. High density is required to develop sufficient **cohesion** within the HMA. The third figure above shows a road suffering from raveling due to inadequate compaction caused by cold weather paving.
- Mechanical dislodging by certain types of traffic (studded tires, snow-plough blades or tracked vehicles). The first and fourth figures above show raveling most likely caused by snow ploughs.

Repair: A ravelled pavement should be investigated to determine the root cause of failure. Repair strategies generally fall into one of two categories:

- *Small, localized areas of raveling.* Remove the ravelled pavement and patch.
- *Large ravelled areas indicative of general HMA failure.* Remove the damaged pavement and overlay.

Rutting (Post consolidation along wheel track)



Mix rutting

Mix rutting

Rutting from mix instability

Description: Surface depression in the wheel path. Pavement uplift (shearing) may occur along the sides of the rut. Ruts are particularly evident after a rain when they are filled with water. There are two basic types of rutting: mix rutting and subgrade rutting. Mix rutting occurs when the subgrade does not rut yet the pavement surface exhibits wheel path depressions as a result of compaction/mix design problems. Subgrade rutting occurs when the subgrade exhibits wheel path depressions due to loading. In this case, the pavement settles into the subgrade ruts causing surface depressions in the wheel path.

Problem: Ruts filled with water can cause vehicle hydroplaning, can be hazardous because ruts tend to pull a vehicle towards the rut path as it is steered across the rut.

Possible Causes: Permanent deformation in any of a pavement's layers or subgrade usually caused by consolidation or lateral movement of the materials due to traffic loading. Specific causes of rutting can be:

- Insufficient compaction of HMA layers during construction. If it is not compacted enough initially, HMA pavement may continue to densify under traffic loads.
- Subgrade rutting (e.g., as a result of insufficient compaction or inadequate pavement structure)
- Improper mix design or manufacture (e.g., excessively high asphalt content, excessive mineral filler, insufficient amount of angular aggregate particles)

Repair: A heavily rutted pavement should be investigated to determine the root cause of failure (e.g. insufficient compaction, subgrade rutting, poor mix design or studded tire wear). Slight ruts (< 1/3 inch deep) can generally be left untreated. Pavement with deeper ruts should be levelled and overlaid.

Slippage Cracking



Slippage cracking at a bus stop



Slippage cracking



Slippage cracking

Description: Crescent or half-moon shaped cracks generally having two ends pointed into the direction of traffic.

Problem: Allows moisture infiltration, roughness

Possible Causes: Braking or turning wheels cause the pavement surface to slide and deform. The resulting sliding and deformation is caused by a low-strength surface mix or poor bonding between the surface HMA layer and the next underlying layer in the pavement structure.

Repair: Removal and replacement of affected area.

Stripping



Core hole showing stripping at the bottom



Stripping at bottom of hole



Fatigue failure from stripping



Description: The loss of bond between aggregates and asphalt binder that typically begins at the bottom of the HMA layer and progresses upward. When stripping begins at the surface and progresses downward it is usually called raveling. The third photo show the surface effects of underlying stripping.

Problem: Decreased structural support, rutting, shoving/corrugations, raveling, or cracking (alligator and longitudinal)

Possible Causes: Bottom-up stripping is very difficult to recognize because it manifests itself on the pavement surface as other forms of distress including rutting, shoving/corrugations, raveling, or cracking. Typically, a core must be taken to positively identify stripping as a pavement distress.

- Poor aggregate surface chemistry
- Water in the HMA causing moisture damage
- Overlays over an existing open-graded surface course.

Repair: A stripped pavement should be investigated to determine the root cause of failure (i.e., how did the moisture get in?). Generally, the stripped pavement needs to be removed and replaced after correction of any subsurface drainage issues.

Transverse (Thermal) Cracking



Large patched thermal crack



Smaller patched thermal crack



Small thermal crack



Description: Cracks perpendicular to the pavement's centerline or laydown direction. Usually a type of thermal cracking.

Problem: Allows moisture infiltration, roughness

Possible Causes: Several including:

- Shrinkage of the HMA surface due to low temperatures or asphalt binder hardening
- Reflective crack caused by cracks beneath the surface HMA layer
- top-down cracking

Repair: Strategies depend upon the severity and extent of the cracking:

- *Low severity cracks (< 1/2 inch wide and infrequent cracks).* Crack seal to prevent (1) entry of moisture into the subgrade through the cracks and (2) further raveling of the crack edges. HMA can provide years of satisfactory service after developing small cracks if they are kept sealed (Roberts et. al., 1996).
- *High severity cracks (> 1/2 inch wide and numerous cracks).* Remove and replace the cracked pavement layer with an overlay.

Water Bleeding and Pumping



Water bleeding



Water bleeding up close

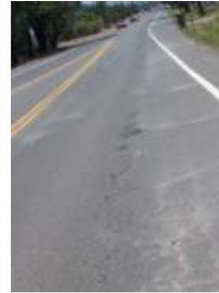

CTB base pumping
through HMA cracks



Description: Water bleeding occurs when water seeps out of joints or cracks or through an excessively porous HMA layer. Pumping (right-most photo) occurs when water and fine material is ejected from underlying layers through cracks in the HMA layer under moving loads.

Problem: Decreased skid resistance, an indication of high pavement porosity (water bleeding), decreased structural support (pumping)

Possible Causes: Several including:

- Porous pavement as a result of inadequate compaction during construction or poor mix design
- High water table
- Poor drainage

Repair: Water bleeding or pumping should be investigated to determine the root cause. If the problem is a high water table or poor drainage, subgrade drainage should be improved. If the problem is a porous mix (in the case of water bleeding) a **fog seal or slurry seal** may be applied to limit water infiltration.

Repair Techniques

Fog Seals

A fog seal is a light application of a diluted slow-setting asphalt emulsion to the surface of an aged (oxidized) pavement surface. Fog seals are low-cost and are used to restore flexibility to an existing HMA pavement surface. They may be able to temporarily postpone the need for a surface treatment or non-structural overlay. Generally, it is recommended as a preventive maintenance measure. Fog seals are used to restore or rejuvenate an HMA surface. They may be able to postpone the need for a Bituminous Surface Treatment (BST) or non-structural overlay for a year or two. Fog seals are suitable for low-volume roads which can be closed to traffic for the 4 to 6 hours it takes for the slow-setting asphalt emulsion to break and set. An excessive application rate may result in a thin asphalt layer on top of the original HMA pavement. This layer can be very smooth and cause a loss of skid resistance. Sand should be kept in reserve to blot up areas of excess application.



Slurry Seals

A slurry seal is a homogenous mixture of emulsified asphalt, water, well-graded fine aggregate and mineral filler that has a creamy fluid-like appearance when applied. Slurry seals are used to fill existing pavement surface defects as either a preparatory treatment for other maintenance treatments or as a wearing course.



Slurry seal close-up.



Slurry seal placement

Micro-surfacing

Micro-surfacing is an advanced form of slurry seal that uses the same basic ingredients (emulsified asphalt, water, fine aggregate and mineral filler) and combines them with advanced polymer additives. Figures 1 through 4 show a micro-surfacing slurry seal project. It is recommended as a preventive maintenance measure. Repair slight to moderate pavement surface defects, improve skid resistance.



Figure 1: Ignition method major equipment.



Figure 2: Micro-surfacing placement.



Figure 3: Micro-surface close-up.

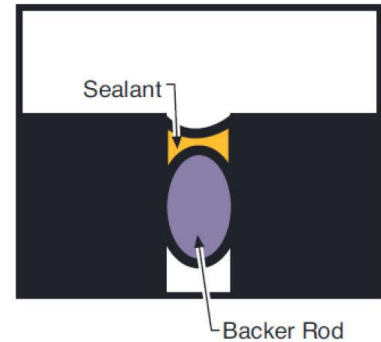

Figure 4: Finished micro-surface.

Crack sealing

Crack sealing should generally be done during the winter months when the cracks are open; and thus, sealant can more easily penetrate the crack. Before placing sealant, all cracks must be thoroughly cleaned to ensure a clean, dry crack channel and to optimize adhesion between the sealant and the pavement surface. To effectively clean the crack, high-pressure air blasting, which uses compressors to produce a jet stream of air, is used to remove dust, debris or loose pavement fragments. The cracks should be cleaned to a depth of at least twice the crack width. Sealant should be placed immediately after crack cleaning.

When sealing large cracks, it is important that the sealant does not drain to the bottom of the crack. To prevent this, sand or backer rods may be placed in the cracks before the placement of the sealant.



Patch Work Steps

1. Mark the area to remove. Crews use paint or chalk to mark a straight-sided rectangle or polygon. Lines should delineate the inclusion of at least a foot of sound pavement surrounding the pothole. Prepare the pothole.
2. Remove damaged material to reach a firm base and make certain the remaining material is sound and free of cracks. This step usually involves three operations: (1) cutting to remove deteriorated pavement material, (2) cleaning the hole of dirt and debris and backfilling if subgrade is removed, and (3) drying with air or heat to eliminate moisture that would negatively affect adhesion.
3. Apply tack to sides and bottom.
4. Immediately before filling, the crew hot mops, pours, or sprays a tack coat onto the sides and bottom of the pothole. The tack improves adhesion between the old pavement and the patching mixture. Tack included: asphalt cement (poured or sprayed while hot), cut-back asphalt (may be poured cold, but is usually slightly heated), and emulsified asphalt (add water to spray, pour, or mop into the hole).
5. Place layers of HMA, compacting each layer, and extend final un-compacted lift above the surrounding pavement.
6. Seal the edges of the patch.



Pavement Distresses

RIGID PAVEMENT DISTRESS

An introduction to common forms of distress in rigid pavements:

Type of Rigid Pavement Distresses	
Blow-up	Reactive Aggregate Distress
Corner Break	Spalling
Durability Cracking	Shrinkage Cracking
Faulting	Polished Aggregate
Joint Load Transfer System Deterioration	Pumping
Linear Cracking	Punchout

The most common pavement distresses in Bangladesh are low to moderate Corner break, Faulting, Joint Load Transfer deterioration, Spalling, Shrinkage cracking and pumping.

Blow-up

Description

A localized upward slab movement and shattering at a joint or crack. Usually occurs in spring or summer and is the result of insufficient room for slab expansion during hot weather.



Figure 1: Blowup on SR 195 in eastern Washington.



Figure 2: Blowup on SR 195 in eastern Washington.

Problem

Roughness, moisture infiltration, in extreme cases (as in the second photo) can pose a safety hazard

Possible Causes

During cold periods (e.g., winter) PCC slabs contract leaving wider joint openings. If these openings become filled with incompressible material (such as rocks or soil), subsequent PCC slab expansion during hot periods (e.g., spring, summer) may cause high compressive stresses. If these stresses are great enough, the slabs may buckle and shatter to relieve the stresses. Blowup can be accelerated by:

- Joint spalling (reduces slab contact area and provides incompressible material to fill the joint/crack)
- D cracking (weakens the slab near the joint/crack area)
- Freeze-thaw damage (weakens the slab near the joint/crack area)

Repair: Full-depth patch

Corner Break

Description:

A crack that intersects the PCC slab joints near the corner. "Near the corner" is typically defined as within about 2 m (6 ft) or so. A corner break extends through the entire slab and is caused by high corner stresses.



Figure 1: Corner break in Seattle, WA on a local road.



Figure 2: Corner break on a high volume road.

Problem:

Roughness, moisture infiltration, severe corner breaks will fault, spall and disintegrate

Possible Causes

Severe corner stresses caused by load repetitions combined with a loss of support, poor load transfer across the joint, curling stresses and warping stresses.

Repair

Full-depth patch

Durability Cracking

Description

Series of closely spaced, crescent-shaped cracks near a joint, corner or crack. It is caused by freeze-thaw expansion of the large aggregate within the PCC slab. Durability cracking is a general PCC distress and is not unique to pavement PCC.

photo courtesy of C.L. Monismith

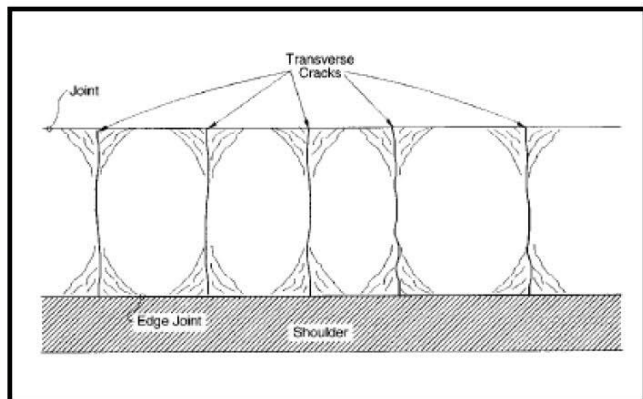

Figure 1: D cracking at a slab

Problem: Some roughness, leads to spalling and eventual slab disintegration

Possible Causes: Freeze-thaw susceptible aggregate.

Repair

"D" cracking is indicative of a general aggregate freeze-thaw problem. Although a full-depth patch or partial-depth patch can repair the affected area, it does not address the root problem and will not, of course, prevent "D" cracking elsewhere.

Faulting

Description

A difference in elevation across a joint or crack usually associated with undoweled JPCP. Usually the approach slab is higher than the leave slab due to pumping, the most common faulting mechanism. Faulting is noticeable when the average faulting in the pavement section reaches about 2.5 mm (0.1 inch). When the average faulting reaches 4 mm (0.15 in), diamond grinding or other rehabilitation measures should be considered.



Figure 1: Faulting - looking in the opposite direction of traffic flow.



Figure 2: Faulting close-up.



Figure 3: Faulting

Problem: Roughness

Possible Causes

Most commonly, faulting is a result of slab pumping. Faulting can also be caused by slab settlement, curling and warping.

Repair

Faulting heights of less than 3 mm (0.125 inch) need not be repaired. Faulting in an undoweled JPCP between 3 mm (0.125 inch) and 12.5 mm (0.5 inch) is a candidate for a dowel bar retrofit. Faulting in excess of 12.5 mm (0.5 inches) generally warrants total reconstruction.

Joint Load Transfer System Deterioration

Description: Transverse crack or corner break developed as a result of joint dowels.



Figure 1: Dowel bar corrosion.



Figure 2: Patch over an area of dowel bar failure.

Problem

Indicator of a failed load transfer system, roughness

Possible Causes

Load transfer dowel bars can fail for two principal reasons:

- **Corrosion.** If inadequately protected, dowel bars can corrode over time. The corrosion products occupy volume, which creates tensile stresses around the dowel bars, and a severely corroded dowel bar is weaker and may fail after repeated loading.
- **Misalignment.** Dowel bars inserted crooked or too close to the slab edge may create localized stresses high enough to break the slab. Misalignment can occur during original construction or during dowel bar retrofits.

Repair

Removal and replacement of the affected joint load transfer system followed by a full-depth patch for affected area.

Linear/Panel Cracking

Description

Linear cracks not associated with corner breaks or blowups that extend across the entire slab. Typically, these cracks divide an individual slab into two to four pieces. Often referred to as "panel cracking".



Figure 1: Large panel cracks on highway.



Figure 2: Multiple panel cracks on a residential street.

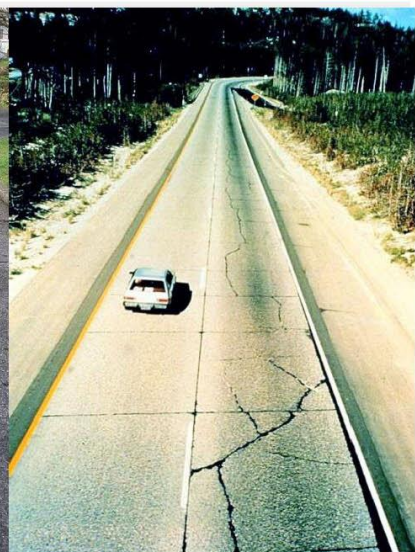

Figure 3: Panel cracks in the truck lane of an Interstate highway.

Problem

Roughness, allows moisture infiltration leading to erosion of base/subbase support, cracks will eventually spall and disintegrate if not sealed

Possible Causes

Usually a combination of traffic loading, thermal gradient curling, moisture stresses and loss of support.

Repair

Slabs with a single, narrow linear crack may be repaired by crack sealing. More than one linear crack generally warrants a full-depth patch.

Reactive Aggregate Distress

Description

Pattern or map cracking (crazing) on the PCC slab surface caused by reactive aggregates. Reactive aggregates are those that either expand or develop expansive by products when introduced to certain chemical compounds.



Figure 1: Severe crazing (alkali-silica reaction).

Problem

Roughness, an indication of poor aggregate – will eventually lead to PCC slab disintegration.

Possible Causes

This type of distress is indicative of poor aggregate qualities. Most commonly, it is a result of an **alkali-aggregate reaction**.

Repair

Partial depth patch for small areas of scaling or slab replacement for large areas of scaling.

Spalling

Description

Cracking, breaking or chipping of joint/crack edges. Usually occurs within about 0.6 m (2 ft.) of joint/crack edge.



Figure 1: Spalling along a linear (panel) crack.



Figure 2: Onset of spalling up close.



Figure 3: Bad construction joint spalling.

Problem

Loose debris on the pavement, roughness, generally an indicator of advanced joint/crack deterioration

Possible Causes

Possible causes are (AASHTO, 1993[1]):

- Excessive stresses at the joint/crack caused by infiltration of incompressible materials and subsequent expansion (can also cause blowups).
- Disintegration of the PCC from freeze-thaw action or "D" cracking.
- Weak PCC at a joint caused by inadequate consolidation during construction. This can sometimes occur at a construction joint if (1) low quality PCC is used to fill in the last bit of slab volume or (2) dowels are improperly inserted.
- Misalignment or corroded dowel.
- Heavy traffic loading.

Repair

Spalling less than 75 mm (3 inches) from the crack face can generally be repaired with a partial-depth patch. Spalling greater than about 75 mm (3 inches) from the crack face may indicate possible spalling at the joint bottom and should be repaired with a full-depth patch.

Shrinkage Cracking**Description**

Hairline cracks formed during PCC setting and curing that are not located at joints. Usually, they do not extend through the entire depth of the slab. Shrinkage cracks are considered a distress if they occur in an uncontrolled manner (e.g., at locations outside of contraction joints in JPCP or too close together in CRCP).



Figure 1: Shrinkage cracking on new slabs.

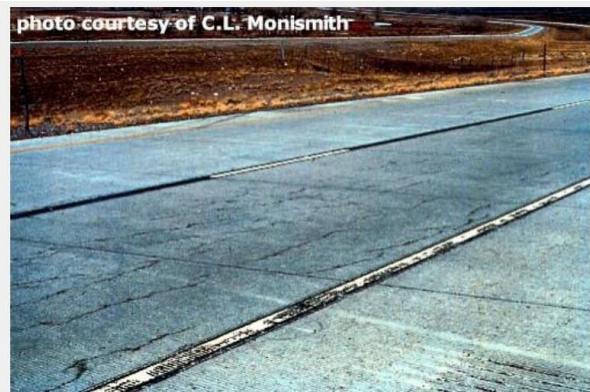

Figure 2: Severe shrinkage cracking.

Problem

Aesthetics, indication of uncontrolled slab shrinkage. In JPCP they will eventually widen and allow moisture infiltration. In CRCP, if they are allowed to get much wider than about 0.5 mm (0.02 inches) they can allow moisture infiltration.

Possible Causes

All PCC will shrink as it sets and cures, therefore shrinkage cracks are expected in rigid pavement and provisions for their control are made. However, uncontrolled shrinkage cracking can indicate:

- Contraction joints sawed too late. In JPCP, if contraction joints are sawed too late the PCC may already have cracked in an undesirable location.
- Poor reinforcing steel design. In CRCP, proper reinforcing steel design should result in shrinkage cracks every 1.2 – 3 m (4 – 10 ft.).
- Improper curing technique. If the slab surface is allowed to dry too quickly, it will shrink too quickly and crack.
- High early strength PCC. In an effort to quickly open a newly constructed or rehabilitated section to traffic, high early-strength PCC may be used. This type of PCC can have a high heat of hydration and shrinks more quickly and to a greater extent than typical PCC made from unmodified Type 1 portland cement.

Repair

In mild to moderate severity situations, the shrinkage cracks can be sealed and the slab should perform adequately. In severe situations, the entire slab may need replacement.

Polished Aggregate

Description

Areas of pavement (either PCC or HMA) where the portion of aggregate extending above the asphalt binder (in the case of HMA) or cement paste (in the case of PCC) is either very small or there are no rough or angular aggregate particles.



Figure 1: Polished PCC aggregate after 40 years of wear.

Figure 2: Close up of polished Hot Mix Asphalt aggregate.

Figure 3: Aggregate from two different SMAs at NCAT test track.

Problem: Decreased skid resistance

Possible Causes

Repeated traffic applications. Generally, as a pavement ages the protruding rough, angular particles become polished. This can occur quicker if the aggregate is susceptible to abrasion or subject to excessive studded tire wear.

Repair

- HMA: Apply a skid-resistant slurry seal or BST or overlay.
- PCC: Diamond grinding or overlay.
- Klaruw: Bush-Hammering or Shot-Blasting.

Pumping

Description

Movement of material underneath the slab or ejection of material from underneath the slab as a result of water pressure. Water accumulated underneath a PCC slab will pressurize when the slab deflects under load. This pressurized water can do one of the following:

- Move about under the slab.
- Move from underneath one slab to underneath an adjacent slab. This type of movement leads to faulting.
- Move out from underneath the slab to the pavement surface. This results in a slow removal of base, subbase and/or subgrade material from underneath the slab resulting in decreased structural support.



Figure 1: Pumping in action.

Figure 2: Broken slabs.

Figure 3: Pumping damage.

Problem

Decreased structural support of the slab, which can lead to linear cracking, corner breaks and faulting.

Possible Causes

Water accumulation underneath the slab. This can be caused by such things as: a high water table, poor drainage, and panel cracks or poor joint seals that allow water to infiltrate the underlying material.

Repair

First, the pumping area should be repaired with a full depth patch to remove any deteriorated slab areas. Second, consideration should be given to using dowel bars to increase load transfer across any significant transverse joints created by the repair. Third, consideration should be given to stabilizing any slabs adjacent to the pumping area as significant amounts of their underlying base, subbase or subgrade may have been removed by the pumping. Finally, the source of water or cause of poor drainage should be addressed.

Punchout**Description**

Localized slab portion broken into several pieces. Typically a concern only with CRCP.



Figure 1: Severe punchout.

Problem

Roughness, allows moisture infiltration leading to erosion of base/subbase support, cracks will spall and disintegrate.

Possible Causes

Can indicate a localized construction defect such as inadequate consolidation. In CRCP, it can be caused by steel corrosion, inadequate amount of steel, excessively wide shrinkage cracks or excessively close shrinkage cracks.

Repair

Full-depth patch.

Joint and Crack Repair

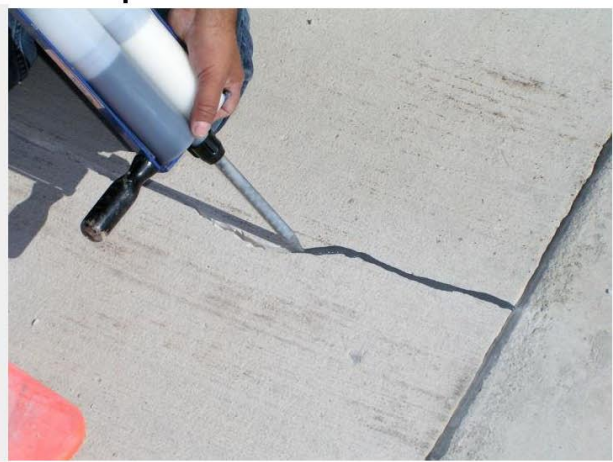

Rubber Stopper



AASHO Road Test

Background

The **AASHO Road Test** was a series of experiments carried out by the American Association of State Highway and Transportation Officials to determine how traffic contributed to the deterioration of highway pavements. Officially, the Road Test was "...to study the performance of pavement structures of known thickness under moving loads of known magnitude and frequency." This study, carried out in the late 1950s in Ottawa, Illinois, is frequently quoted as a primary source of experimental data when vehicle wear to highways is considered, for the purposes of road design, vehicle taxation and costing.

The road test consisted of six two-lane loops along the future alignment of Interstate 80. Each lane was subjected to repeated loading by a specific vehicle type and weight. The pavement structure within each loop was varied so that the interaction of vehicle loads and pavement structure could be investigated.

The results from the AASHO road test were used to develop a pavement design guide, first issued in 1961 as the "AASHO Interim Guide for the Design of Rigid and Flexible Pavements", with major updates issued in 1972 and 1993. The 1993 version is still in widespread use in the United States. A new guide, originally planned for release in 2002 but as yet still under development, would be the first AASHTO pavement design guide not primarily based on the results of the AASHO road test.

Test Facilities

Six 2-lane test loops (see Figure 1)

Loop 1 = not subject to traffic, used to test environmental effects

Loops 2 through 6 = subject to traffic described in Figure 2

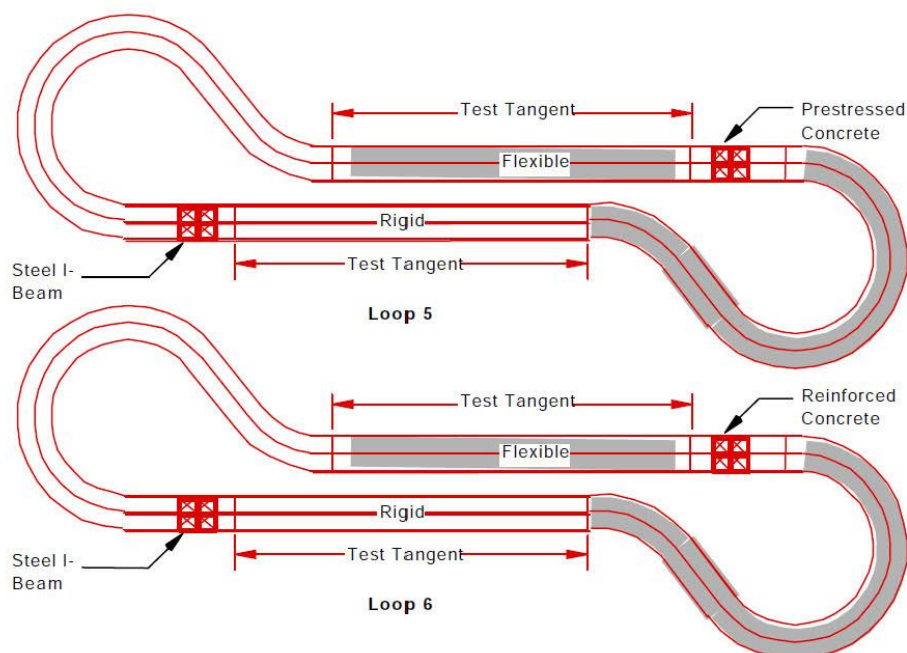

Figure 1: Loop 5 and 6 AASHO Road Test Layout (redrawn from Highway Research Board, 1961)













Loop	Lane	Weight in Kips		
		Front Axle	Load Axle	Gross Weight
②	① 	2	2	4
	② 	2	6	8
③	① 	4	12	28
	② 	6	24	54
④	① 	6	18	42
	② 	9	32	73
⑤	① 	6	22.4	50.8
	② 	9	40	89
⑥	① 	9	30	69
	② 	12	48	108

Figure 2: Axle Weights and Distributions Used on Various Loops of the AASHO Road Test (redrawn from Highway Research Board, 1961)



MAJOR TECHNICAL FINDINGS OF THE AASHO ROAD TEST

Surface Thickness

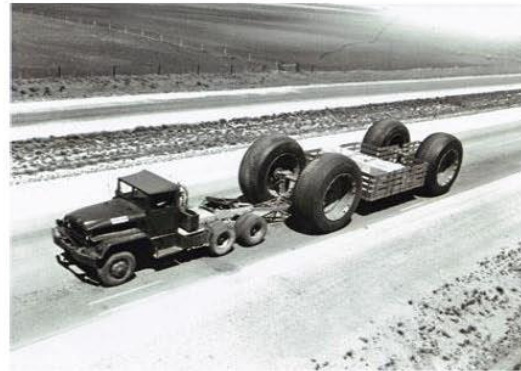
The AASHO Road Test gave quantitative value to the importance of pavement surface thickness in increasing the number of load repetitions that can be carried to pavement failure. It tied pavement surface thickness to pavement performance, where “performance” is defined as the service provided by the pavement or the number of load repetitions that can be carried to an unserviceable level.

Load Equivalency/Damage Factor

Pavement engineers had long had trouble dealing with various axle loads in pavement design. Some methods used only the heaviest load (CBR), and others including the Texas Design Method used the average of the 10 heaviest loads that were expected to be carried on the pavement. The AASHO Road Test provided quantitative information about the relative damaging effect of heavy loads, and immediately after the Road Test, Paul Irick and Frank Scrivner used the Road Test equations to generate load equivalencies called ESALs. Francis Hveem of the California DOT had earlier hypothesized a load equivalency concept tied to 10-kip axles. The Road Test equivalencies validated and extended the Hveem hypothesis statistically. The load equivalency concept (ESAL) is by far the most widely used pavement concept in the world. We as authors have collectively visited more than 50 countries and all 50 states in the United States. All of these agencies use the ESAL concept in pavement design.

PSI: Performance/Serviceability Concept

Before the AASHO Road Test there was no good definition of pavement failure. This seems hard to believe but please check the literature; you will find it to be true. After the WASHO Road Test, Paul Irick and Bill Carey developed the Present Serviceability Index (PSI) concept and defined “performance” as “accumulated traffic to a fixed level of PSI.” The selected level of PSI was “failure.” While many agencies adopted this concept, some have continued to refer to “roughness.” Therefore, a defined level of roughness is sometimes accepted as failure in the form of an International Roughness Index (IRI) level. The technical literature shows that IRI and PSI are inversely related to each other.

The present serviceability concept (PSI) relates pavement failure directly to riding quality and the acceptance or satisfaction of the riding public. It is indeed more definitive of true performance than roughness alone and strong consideration should be given to resurrecting it in pavement studies and designs.

Structural number Concept/Layer Equivalencies: Material Properties

The AASHO Road Test included four types of base under asphalt pavements: (a) river gravel, (b) cement stabilized, (c) asphalt stabilized, and (d) crushed stone. These were compared to define the levels of performance that resulted from improving the quality of the base layer. Francis Hveem had also hypothesized such relative benefit of stronger layers as part of a "gravel equivalency concept" and he was instrumental in getting the wedge-shaped base sections added to the Road Test to validate that concept. The structural number concept, developed based on layer equivalencies, is widely used around the world and is the basis for layer selection in all AASHTO Pavement Design Guides up to 2002.

The Road Test of course was not perfect because it was impossible to make it large enough to solve all possible factors. We don't know if these layer equivalencies would be the same with different subgrades and in a different environment. These questions have been the subject of considerable research in the past 50 years.

Value of Subbase to Reduce Pumping in Rigid Pavements

At the Road Test those PCC pavement sections that had a gravel subbase under the slab performed much better than those that were placed directly on the clay subgrade. This occurred regardless of the thickness of the gravel subbase layer. However, there were no stabilized subbases used on the rigid pavements and we can only hypothesize what improvement would have resulted.

Pumping of Subbase and Subgrade Materials

Before the Road Test the PCC paving industry had strongly hypothesized that the problem of pumping of subgrade material from beneath pavements could be solved by placing a granular subbase beneath the slab. This was proved to be incorrect at the Road Test, where under heavy loads and high rainfall, even the gravel subbase layer pumped and caused early slab failure.

Effectiveness of Dowels for Load Transfer

Before 1960 most people were of the opinion that it was necessary to put some form of positive load transfer across joints and cracks in PCC pavements. Yet the concrete industry continued to claim that thicker pavements would solve the problem. The Road Test used load transfer dowels in all pavement sections. There was no faulting at the AASHO Road Test at cracks or joints, thus validating the effectiveness of dowels for load transfer under extremely heavy loads up to 30,000 pounds on a single axle.

Joint Spacing

Two joint spacings were used at the AASHO Road Test: 15-ft joint spacing with no reinforcement steel and 40-ft joint spacing with mild reinforcement. Both of these joint spacings performed well under heavy loads up to 30-kip single axle and both contained dowels across the joints. The 40-ft slabs cracked at approximately 12- to 15-ft spacing, and no faulting occurred at those cracks during the test. However, 15 years later, field studies of some of these same sections left in service on IH 80 did show faulting as the mild reinforcement steel rusted and lost its effectiveness.

Outcomes/Achievement of AASHO Road Test

- Serviceability Concept – PSI
- Traffic Damage Factors – ESALs
- Structural Number Concept – SN
- Empirical Process
- Simplified Pavement Design

Limitations of the AASHO Road Test Findings

Nothing is perfect, and there are several limitations of the AASHO Road Test findings. They are as follows:

1. One subgrade only—the Road Test was carried out on a lean clay subgrade and therefore no direct inference to other subgrades can be made.
2. Only 2 years long—the Road Test was conducted during the period October 1958 to December 1960 and related primarily to this time period and the climatic conditions existing during that period.
3. One environment only—the Road Test took place in Central Illinois, which is a freeze-thaw, wet environment. Information is needed to extend it to other environments.
4. One AC mix only—a single high-quality AC was used in the AASHO Road Test.
5. Information related to other qualities of asphalt concrete surfacing must be inferred in other ways.
6. One PCC mix only—a single high-quality PCC was used in the AASHO Road Test.
7. Information about the performance of other strengths of PCC must be inferred from other sources.

Pavement Design

Type of Pavements

- Bounded pavement (for high-volume roads)
 - Portland Cement Concrete Surface
 - Asphalt Concrete Surface
- Unbounded pavement - Aggregate/Granular material surfaced (for low-volume roads)

Objectives of Structural Design of Pavements

- to determine total thickness of pavement structure as well as
- to determine the individual layer thickness

Performance (life cycle) of pavement depends upon

- Traffic forecasting
- Weather forecasting
- Pavement design
- Construction control
- Maintenance practices
- Overweight vehicle control

As such pavement design involves more than choosing thicknesses.

Design Considerations

- Pavement performance
- Traffic
- Roadbed soil
- Construction materials
- Environment
- Drainage
- Reliability
- Life-cycle cost
- Shoulder design

Pavement Design Consists of

- Geometric design - to fix geometric profiles and dimensions of roadways
- Structural design - to know layer thickness and reinforcement requirements
- Mix design - to design paving mixes of required strength

Why structural design of pavement is a complex one?

Unlike the structural design of buildings and bridges - for pavement

- traffic loading pattern
 - is repetitive in nature
 - causes stresses of wide varying intensities
 - forecast is very difficult and become less reliable with longer design period
- environment loading pattern - as the pavement lies exposed upon the ground surface, it is greatly influenced by the environment factors viz.
 - **shrinkage** crack of slab due to temperature change
 - **swelling** of roadbed soil due to change moisture content
 - **pumping** - loss of roadbed material with water
 - **stripping** - break of bonding between aggregates at submerged condition

Theses **stress-inducing factors** are extremely complex and to some extent difficult to predict.

Moreover, as highway crosses many different soil deposits along its course, foundation analysis become more complex than that of building/bridges.

Design Parameters

- Subgrade
- Loads
- Environment

Subgrade

Characterized by strength and/or stiffness

- California Bearing Ratio (CBR)
 - Measures shearing resistance
 - Units: percent
 - Typical values: 0 to 20
- Resilient Modulus (M_R)
 - Measures stress-strain relationship
 - Units: psi or MPa
 - Typical values: 3,000 to 40,000 psi

Some Typical Values

Classification	CBR	M_R (psi)	Typical Description
Good	≥ 10	20,000	Gravels, crushed stone and sandy soils. GW, GP, GM, SW, SP, SM soils are often in this category.
Fair	5 – 9	10,000	Clayey gravel and clayey sand, fine silt soils. GM, GC, SM, SC soils are often in this category.
Poor	3 – 5	5,000	Fine silty sands, clays, silts, organic soils. CL, CH, ML, MH, CM, OL, OH soils are often in this category.

Loads*Load characterization*

- Tire loads
- Axle and tire configurations
- Load repetition
- Traffic distribution
- Vehicle speed

Load Quantification

- Equivalent Single Axle Load (ESAL)
- Converts wheel loads of various magnitudes and repetitions ("mixed traffic") to an equivalent number of "standard" or "equivalent" loads
- Based on the amount of damage they do to the pavement
- Commonly used standard load is the 18,000 lb or 18-kip/8.2t equivalent single axle load
- As truck traffic causes maximum damage to pavement, it is very important to correctly estimate future truck traffic for the facility during the design period.

Load Equivalency

- Generalized fourth power approximation

$$\left(\frac{\text{load}}{18,000\text{lb.}} \right)^4 = \text{relative damage factor}$$

- Load equivalency factors are presented in Tables for a range of
 - axle configurations
 - pavement structural combinations
 - terminal serviceability values

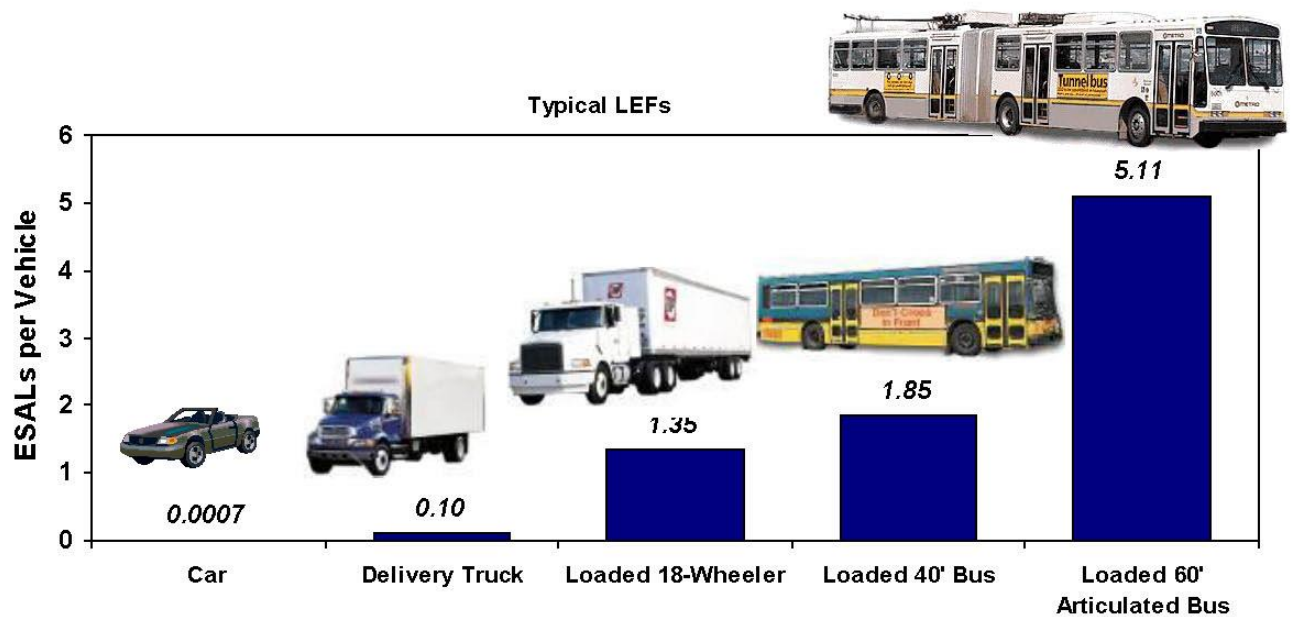
**LEF Example**

The standard axle weights for a standing-room-only loaded Metro articulated bus (60 ft. Flyer) are:

Axle	Empty	Full
Steering	13,000 lb.	17,000 lb.
Middle	15,000 lb.	20,000 lb.
Rear	9,000 lb.	14,000 lb.

Using the 4th power approximation, determine the total equivalent damage caused by this bus in terms of ESALs when it is empty. How about when it is full?

**Pavement Design Methods**

- Flexible Pavement
 - Design Catalog method
 - Empirical - 1993 AASHTO method
 - Mechanistic-empirical - New AASHTO method
 - Asphalt Institute Method
 - TRL- Road Note 31 method
 - AustRoads method &
 - IRC (Indian Road Congress) method
- Rigid Pavement
 - Empirical - 1993 AASHTO method
 - PCA (Portland Cement Association) Method
 - TRL- Road Note 29 method

1993 AASHTO Flexible Pavement Structural Design

Empirical equations are used to relate observed or measurable phenomena (pavement characteristics) with outcomes (pavement performance). This article presents the 1993 AASHTO *Guide* basic design equation for flexible pavements. This empirical equation is widely used and has the following form:

$$\log_{10}(W_{18}) = Z_R \times S_0 + 9.36 \times \log_{10}(SN+1) - 0.20 + \frac{\log_{10}\left(\frac{\Delta PSI}{4.2-1.5}\right)}{0.40 + \frac{1094}{(SN+1)^{5.19}}} + 2.32 \times \log_{10}(M_R) - 8.07$$

where: W_{18} = predicted number of 80 kN (18,000 lb) ESALs

Z_R = standard normal deviate

S_0 = combined standard error of the traffic prediction and performance prediction

SN = Structural Number (an index that is indicative of the total pavement thickness required)

= $a_1 D_1 + a_2 D_2 m_2 + a_3 D_3 m_3 + \dots$ a_i = i^{th} layer coefficient D_i = i^{th} layer thickness (inches) m_i = i^{th} layer drainage coefficient

ΔPSI = difference between the initial design serviceability index, p_0 , and the design terminal serviceability index, p_t

M_R = subgrade resilient modulus (in psi)

The design Nomo-graph appended at the end of this section is also solve the equation for

- the structural number (SN) for flexible pavements
- the thickness (D) of the pavement slab for rigid pavements

Assumptions

From the AASHTO Road Test, equations were developed which related loss in serviceability, traffic, and pavement thickness. Because they were developed for the specific conditions of the AASHTO Road Test, these equations have some significant limitations:

- The equations were developed based on the specific pavement materials and roadbed soil present at the AASHTO Road Test.
- The equations were developed based on the environment at the AASHTO Road Test only.
- The equations are based on an accelerated two-year testing period rather than a longer, more typical 20+ year pavement life. Therefore, environmental factors were difficult if not impossible to extrapolate out to a longer period.
- The loads used to develop the equations were operating vehicles with identical axle loads and configurations, as opposed to mixed traffic.
- In order to apply the equations developed as a result of the AASHTO Road Test, some basic assumptions are needed:
- The characterization of subgrade support may be extended to other subgrade soils by an abstract soil support scale.
- Loading can be applied to mixed traffic by use of ESALs.
- Material characterizations may be applied to other surfaces, bases, and subbases by assigning appropriate layer coefficients.
- The accelerated testing done at the AASHTO Road Test (2-year period) can be extended to a longer design period.

When using the 1993 AASHTO *Guide* empirical equation or any other empirical equation, it is extremely important to know the equation's limitations and basic assumptions. Otherwise, it is quite easy to use an equation with conditions and materials for which it was never intended. This can lead to invalid results at the least and incorrect results at the worst.

Inputs

The 1993 AASHTO *Guide* equation requires a number of inputs related to loads, pavement structure and subgrade support. These inputs are:

- **The predicted loading.** The predicted loading is simply the predicted number of 80 kN (18,000 lb.) ESALs that the pavement will experience over its design lifetime.

- **Reliability.** The reliability of the pavement design-performance process is the probability that a pavement section designed using the process will perform satisfactorily over the traffic and environmental conditions for the design period. In other words, there must be some assurance that a pavement will perform as intended given variability in such things as construction, environment and materials. The Z_R and S_o variables account for reliability.
 - **Pavement structure.** The pavement structure is characterized by the Structural Number (SN). The Structural Number is an abstract number expressing the structural strength of a pavement required for given combinations of soil support (M_R), total traffic expressed in ESALs, terminal serviceability and environment. The Structural Number is converted to actual layer thicknesses (e.g., 150 mm (6 inches) of HMA) using a layer coefficient (a) that represents the relative strength of the construction materials in that layer. Additionally, all layers below the HMA layer are assigned a drainage coefficient (m) that represents the relative loss of strength in a layer due to its drainage characteristics and the total time it is exposed to near-saturation moisture conditions. Generally, quick-draining layers that almost never become saturated can have coefficients as high as 1.4 while slow-draining layers that are often saturated can have drainage coefficients as low as 0.40. Keep in mind that a drainage coefficient is basically a way of making a specific layer thicker. If a fundamental drainage problem is suspected, thicker layers may only be of marginal benefit – a better solution is to address the actual drainage problem by using very dense layers (to minimize water infiltration) or designing a drainage system. Because of the peril associated with its use, often times the drainage coefficient is neglected (i.e., set as $m = 1.0$).
 - **Serviceable life.** The difference in present serviceability index (PSI) between construction and end-of-life is the serviceability life. The equation compares this to default values of 4.2 for the immediately-after-construction value and 1.5 for end-of-life (terminal serviceability). Typical values used now are:
 - Post-construction: 4.0 – 5.0 depending upon construction quality, smoothness, etc.
 - End-of-life (called "terminal serviceability"): 1.5 – 3.0 depending upon road use (e.g., highway, urban arterial, residential)
- Total loss of serviceability, $\Delta PSI = \Delta PSI_{\text{Traffic}} + \Delta PSI_{\text{Swell}}$
 Loss due to swelling can be minimized by stabilizing/replacing expansive soil.
- **Subgrade support.** Subgrade support is characterized by the subgrade's resilient modulus (M_R). Intuitively, the amount of structural support offered by the subgrade should be a large factor in determining the required pavement structure.

Outputs

The 1993 AASHTO *Guide* equation can be solved for any one of the variables as long as all the others are supplied. Typically, the output is either total ESALs or the required Structural Number (or the associated pavement layer depths). To be most accurate, the flexible pavement equation described in this chapter should be solved simultaneously with the flexible pavement ESAL equation. This solution method is an iterative process that solves for ESALs in both equations by varying the Structural Number. It is iterative because the Structural Number (SN) has two key influences:

1. The Structural Number determines the total number of ESALs that a particular pavement can support. This is evident in the flexible pavement design equation presented in this section.
2. The Structural Number also determines what the 80 kN (18,000 lb.) ESAL is for a given load.

Therefore, the Structural Number is required to determine the number of ESALs to design for before the pavement is ever designed. The iterative design process usually proceeds as follows:

1. Determine and gather flexible pavement design inputs (Z_R , S_o , ΔPSI and M_R).
2. Determine and gather flexible pavement ESAL equation inputs (L_x , L_{2x} , G).
3. Assume a Structural Number (SN).
4. Determine the equivalency factor for each load type by solving the ESAL equation using the assumed SN for each load type.
5. Estimate the traffic count for each load type for the entire design life of the pavement and multiply it by the calculated ESAL to obtain the total number of ESALs expected over the design life of the pavement.
6. Insert the assumed SN into the design equation and calculate the total number of ESALs that the pavement will support over its design life.
7. Compare the ESAL values in #5 and #6. If they are reasonably close (say within 5 percent) use the assumed SN. If they are not reasonably close, assume a different SN, go to step #4 and repeat the process.

In practice, the flexible pavement design equation is usually solved independently of the ESAL equation by using an ESAL value that is assumed independent of structural number. Although this assumption is not true, pavement structure depths calculated using it are reasonably accurate. This design process usually proceeds as follows:

1. Assume a structural number (SN) for ESAL calculations. Although often not overtly stated, a structural number must be assumed in order to calculate ESALs.
2. Determine the load equivalency factor (LEF) for each load type by solving the ESAL equation using the assumed SN for each load type. Typically, a standard set of load types is used (e.g., single unit trucks, tractor-trailer trucks and buses).
3. Estimate the traffic count for each load type for the entire design life of the pavement and multiply it by the calculated LEF to obtain the total number of ESALs expected over the design life of the pavement.
4. Determine and gather flexible pavement design inputs (Z_R , S_o , ΔPSI and M_R).
5. Solve the design equation for SN.
6. Check to see that the computed SN value is reasonably close to that assumed for ESAL calculations. This step of often neglected.

Design Utility

This design utility solves the 1993 AASHTO *Guide* basic design equation for flexible pavements. It also supplies some basic information on variable descriptions, typical values and equation precautions.

1993 AASHTO Empirical Equation for Flexible Pavements

Equation Solver
Variable Descriptions and Typical Values
Precautions

Type in data in the grey boxes and click the calculate button to see the output. To make additional calculations, change the desired input data and click the calculate button again. Click on the text descriptions of the input or output variables for more information.

INPUT	OUTPUT															
<p>1. Loading</p> <p>Total Design ESALs (W_{18}): <input style="width: 80px;" type="text"/></p> <p>2. Reliability</p> <p>Reliability Level in percent (R): <input style="width: 40px; text-align: center;" type="text"/> 50 ▼</p> <p>Combined Standard Error (S_o): <input style="width: 60px; text-align: center;" type="text"/> 0.5</p> <p>3. Serviceability</p> <p>Initial Serviceability Index (p_i): <input style="width: 60px; text-align: center;" type="text"/> 4.5</p> <p>Terminal Serviceability Index (p_t): <input style="width: 60px; text-align: center;" type="text"/> 3</p> <p>4. Layer Parameters</p> <p>Number of Base Layers: <input style="width: 40px; text-align: center;" type="text"/> 0 ▼</p> <table style="width: 100%; border-collapse: collapse; margin-top: 10px;"> <thead> <tr> <th style="width: 15%;"></th> <th style="width: 15%; text-align: center;">a</th> <th style="width: 15%; text-align: center;">m</th> <th style="width: 15%; text-align: center;">M_R</th> <th style="width: 40%; text-align: center;">Min. Depth</th> </tr> </thead> <tbody> <tr> <td>Surface</td> <td style="text-align: center;"><input style="width: 40px; text-align: center;" type="text"/> 0.44</td> <td style="text-align: center;">1.0</td> <td style="text-align: center;">N/A</td> <td style="text-align: center;"><input style="width: 40px; text-align: center;" type="text"/> 0</td> </tr> <tr> <td>Subgrade</td> <td style="text-align: center;">N/A</td> <td style="text-align: center;">N/A</td> <td style="text-align: center;"><input style="width: 40px; text-align: center;" type="text"/> 10000</td> <td style="text-align: center;">N/A</td> </tr> </tbody> </table>		a	m	M_R	Min. Depth	Surface	<input style="width: 40px; text-align: center;" type="text"/> 0.44	1.0	N/A	<input style="width: 40px; text-align: center;" type="text"/> 0	Subgrade	N/A	N/A	<input style="width: 40px; text-align: center;" type="text"/> 10000	N/A	<p>1. Calculation Parameters</p> <p>Standard Normal Deviate (z_R): <input style="width: 60px; text-align: center;" type="text"/> 0</p> <p>ΔPSI: <input style="width: 60px;" type="text"/></p> <p>Design Structural Number (SN): <input style="width: 60px;" type="text"/></p> <p>2. Layer Depths (to the nearest 1/2 inch)</p> <p>Surface: <input style="width: 60px;" type="text"/></p> <p>Total SN based on layer depths: <input style="width: 60px;" type="text"/></p> <div style="border: 1px solid black; height: 80px; margin-top: 20px; padding: 5px;"> <p>Comments</p> </div>
	a	m	M_R	Min. Depth												
Surface	<input style="width: 40px; text-align: center;" type="text"/> 0.44	1.0	N/A	<input style="width: 40px; text-align: center;" type="text"/> 0												
Subgrade	N/A	N/A	<input style="width: 40px; text-align: center;" type="text"/> 10000	N/A												
<input style="width: 200px; height: 25px; border: 1px solid gray; border-radius: 10px;" type="button" value="Calculate"/>																

New AASHTO Method

- Mechanistic-empirical
- Can use load spectra (instead of ESALs)
- Computationally intensive
- Rigid design takes about 10 to 20 minutes
- Flexible design can take several hours

NOMOGRAPH SOLVES:

$$\log_{10} W_{18} = Z_R \cdot S_o + 9.36 + \log_{10}(SN+1) - 0.20 + \frac{\log_{10} \left[\frac{\Delta PSI}{4.2 - 1.5} \right]}{0.40 + \frac{1094}{(SN+1)^{5.19}}} + 2.32 \cdot \log_{10} M_R - 8.07$$

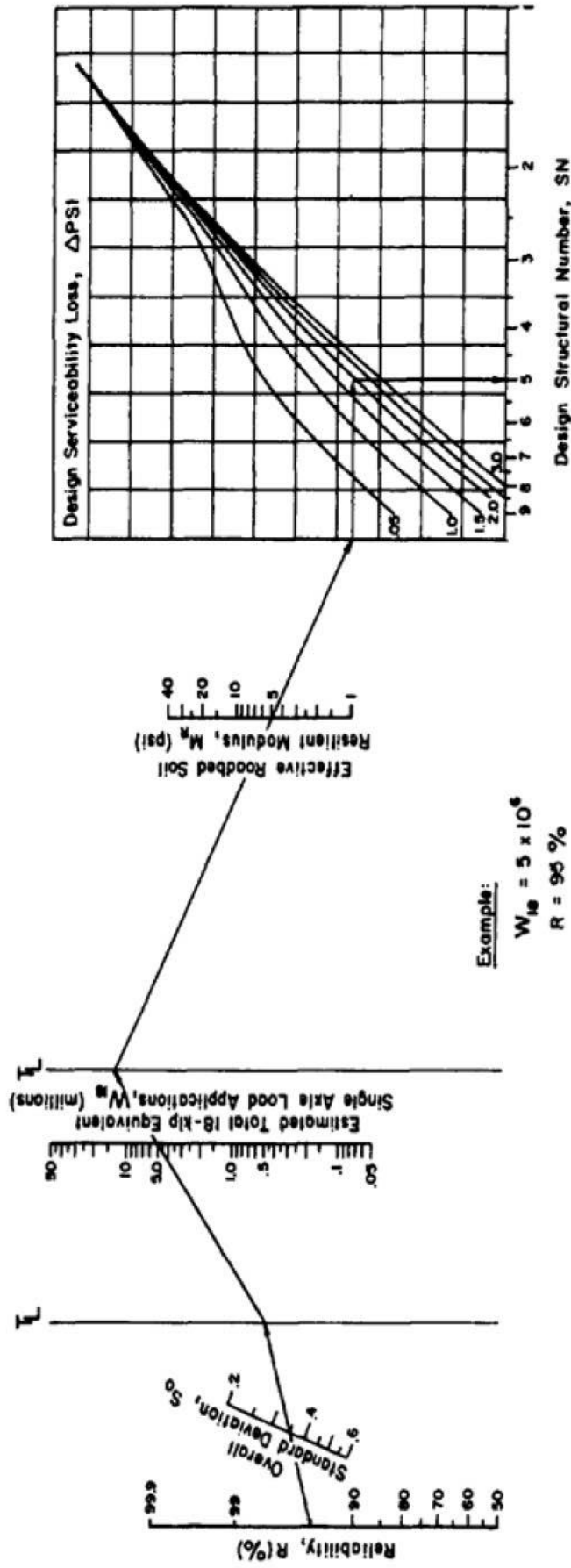
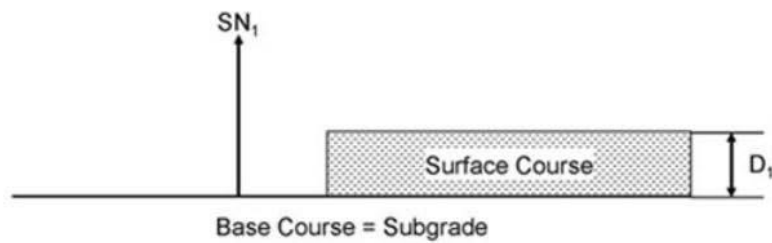
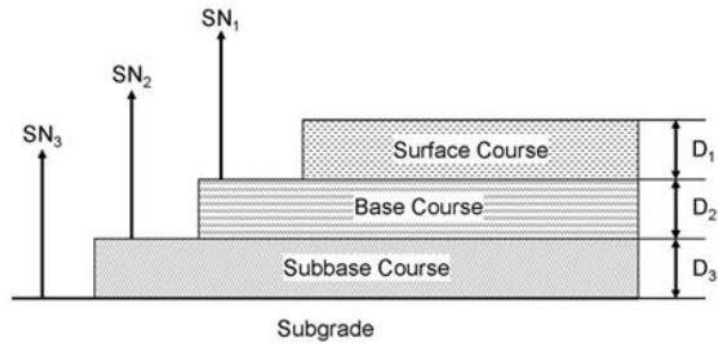

FIGURE AASHTO design chart for flexible pavements based on using mean values for each input. (Courtesy American Association of Highway and Transportation Officials.)

Layer Concept of Structural Design



$$a_1 D_1^* \geq SN_1 \Rightarrow D_1^* \geq \frac{SN_1}{a_1}$$

* Denotes actual value used, which is rounded to the nearest 1/2 inch in thickness

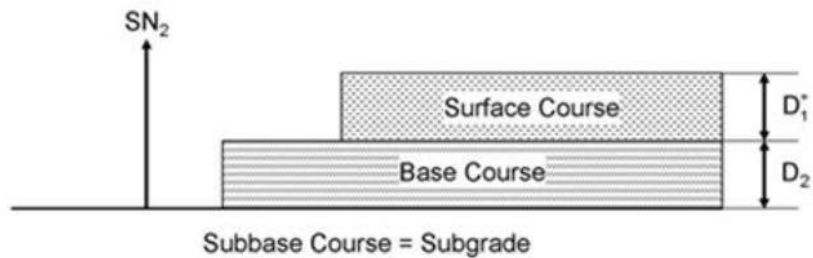

$$a_1 D_1^* + a_2 D_2^* \geq SN_2 \Rightarrow D_2^* \geq \frac{SN_2 - a_1 D_1^*}{a_2}$$

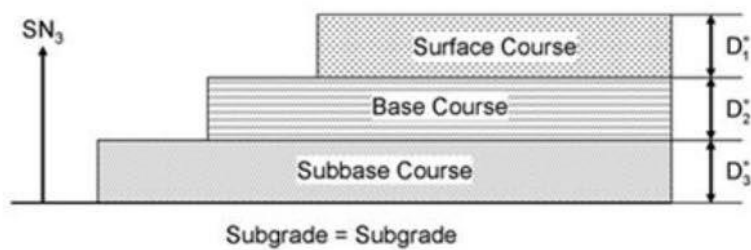

$$a_1 D_1^* + a_2 D_2^* + a_3 D_3^* \geq SN_3 \Rightarrow D_3^* \geq \frac{SN_3 - a_1 D_1^* - a_2 D_2^*}{a_3}$$

Design Example – Part 1

Worksheet for Calculating Design 18-kip ESAL**Example 1**

Determine ESAL for the following axle load distribution survey data:

Highway type = 4-lane rural highway
 Design year = 20 yr
 Uniform growth rate = 5.5 %
 Total no. of trucks weighed = 1000 (one day & both directions)

Assume:

Terminal Serviceability, P_t = 2.5
 Structural Number, SN = 6.0

Solution

Axle Load Groups (kip)	Number of Axles, N	Equivalency Factor*, F	ESAL N x F
Single Axles			
0 - 3	0	0.0002	0.00
3 - 7	8	0.0055	0.04
7 - 8	400	0.0255	10.20
8 - 12	1200	0.0800	96.00
12 - 15	425	0.3003	127.61
26 - 30	375	5.9800	2242.50
Tandem Axle			
0 - 6	0	0.0010	0.00
6 - 12	23	0.0045	0.10
12 - 18	167	0.0335	5.59
18 - 24	400	0.1380	55.20
24 - 30	287	0.4110	117.96
30 - 32	450	0.7335	330.08
32 - 34	460	0.9570	440.22
34 - 36	453	1.2300	557.19

18-kip EAL's for all trucks weighed = 3982.69

Per day total ESAL = 3983 no.
 Directional distribution = 0.5 (As AADT is counted for both directions)
 Lane distributions = 0.9 (From Table 1)

Base year ESAL = $365 \times 3982.69 \times 0.5 \times 0.9 = 654157$

Design ESAL = $[(1 + 0.06)^{20} - 1] / 0.06 \times 654157 = 24063552$

From Nomograph, SN for design ESAL = 5.71 ; which is equal to the assumed value and as such no further trial is needed.

Note: *From interpolation of Table 1 & Table 2.

Worksheet for Calculating Design 18-kip ESAL

Example

Highway type	= 4-lane rural highway	Assumed: SN or D =	6
Design year	= 20	Pt =	2.5
Average Daily Traffic	= 10,034 (both direction)		

Vehicle Types	Current AADT (A)	Growth Factors (B)	Forecasted Traffic (C)	ESAL Factor* (D)	Forecasted ESAL (E)
Passenger cars	5,925	2% 24.30	52,546,099	0.0008	42,037
Small Buses	235	2% 24.30	2,084,107	0.0081	16,798
Large Buses	450	24.30		0.6806	
Pickup trucks	1,135	4% 29.78	12,336,314	0.0122	150,503
2-axle/6-tire trucks	375	29.78	4,075,875	0.6560	2,673,774
3 or more axle trucks	34	29.78	369,546	0.8646	319,509
5 or more axle trailers	1,880	1% 29.78	20,433,718	2.3719	48,466,735
All vehicles	10,034				51,669,355

Directional Distribution = 0.5 (As AADT is counted for both directions)

Lane distributions = 0.9 (From Table 1)

Therefore, design ESAL = $51669355 \times 0.5 \times 0.9 = 23,251,210$

From Figure 3.1 SN for design ESAL or $W_{18} = 5.71$; which is equal to the assumed value and as such no further trial is needed.

Notes:

A = base year annual average daily traffic in both direction; obtained from vehicle counting stations representative of the design location

B = growth factor for each type of vehicle; assuming annual compounded rate of growth factor = $[(1+g)^n - 1]/g$; where g = % growth, n = design year

C = $A \times B \times 365$

D = equivalent single axle factors for assumed SND & Pt

obtained either directly from relevant agencies or calculated based on axle load distribution data from weigh stations

may be supplied in the form of load factor for **each vehicle classes**

(say for 1000 cars it is found that car has an average ESAL of .8 then load factor for each car would be 0.0008)

if axle load distribution for all vehicles is available from weigh stations; then it is possible to calculate ESAL factors for **each axle groups**

In this example equivalence factors for each vehicle classes are derived from limited weight studies

E = C x D

Design Example – Part 2

Design of Flexible Pavement using AASHTO Method

Example 1

Design for the following data:

Traffic Data: Same as ESAL example

Estimated Design ESAL, W_{18} = 23.3 milion (from ESAL example)
 Overall Growth Factor, g = 6.0

Soil Characteristics:

Soil type is highly active swelling clay
 Drainage system need to be provided to cope with the excess moisture
 Swell probability, P_s = 60 (% of total area subject to swell)
 Swell Rate Constant, C = 0.1
 Verical Rise of Roadbed Soil, V_1 = 2.0

Pavement Data:

Initial Servicability, P_o = 4.6
 Terminal Servicability, P_t = 2.5
 Loss of serviceability, $LPSI = P_o - P_t$ = 2.1

Design Strategy:

Consider two-stage construction (i.e. planned rehabilitation).
 Design Period = 20 years
 Initial service life of the pavement = 15 years

Statistical Data:

Reliability for each stage, R = 0.95 (or $0.9^{1/2}$)
 Assuming overall std. dev., S_o = 0.35
 Z_R = -1.645

Worksheet For Flexible Pavement Design

Pavement Layer	Material Used	Resilient Modulus ¹ M_R (psi)	Calculations For Layer Coefficients	Drainage Coefficient ²	Required SN above the layer ³	Calculations For Layer Thicknesses	Thickness D^* (inch)
Surface Course	Asphalt Concrete	$E_{AC} = 400,000$	$a_1 = 0.169 \cdot \ln(E_{AC}) - 1.764 = 0.42$	$m_1 = 1.0$	-	$D_1^* = SN_1 / (a_1 m_1) = 3.31 / 0.42 = 7.88$ $SN_1^* = a_1 D_1^* = 0.42 \times 8 = 3.36$	8.0
Base Course	Granular	$E_{BS} = 30,000$	$a_2 = 0.249 \cdot \log_{10}(E_{BS}) - 0.977 = 0.14$	$m_2 = 1.2$	$SN_1 = 3.31$	$D_2^* = (SN_2 - SN_1^*) / (a_2 m_2) = (4.65 - 3.36) / (0.14 \times 1.2) = 7.68$ $SN_2^* = a_2 m_2 D_2^* = 0.14 \times 1.2 \times 8 = 1.34$	8.0
Subbase Course	Granular	$E_{SB} = 11,000$	$a_3 = 0.227 \cdot \log_{10}(E_{SB}) - 0.839 = 0.08$	$m_3 = 1.2$	$SN_2 = 4.65$	$D_3^* = (SN_3 - (SN_1^* + SN_2^*)) / (a_3 m_3) = (5.71 - (3.36 + 1.34)) / (0.08 \times 1.2) = 10.48$	10.5
Roadbed Course	Compacted soil	$E_{RB} = 5,700$			$SN_3 = 5.71$		

Check for $SN_3 = a_1 m_1 D_1 + a_2 m_2 D_2 + a_3 m_3 D_3 = 8 \cdot 0.42 \cdot 1 + 8 \cdot 0.14 \cdot 1.2 + 10.5 \cdot 0.08 \cdot 1.2 = 5.71$

Check if assumed SN in ESAL calculation is equal to SN_3 or not.

Note: 1. Based on laboratory experiments
 3. Based on Figure 3.1 - Design Chart For Flexible Pavement or solving the equation as follows:

Apply Trial & Error	RHS	LHS
SN_1	3.31	$\log_{10} W_{18}$
SN_2	4.65	7.366446
SN_3	5.71	7.366660

4. Thicknesses are rounded and checked for minimum requirements (SEE Table..)

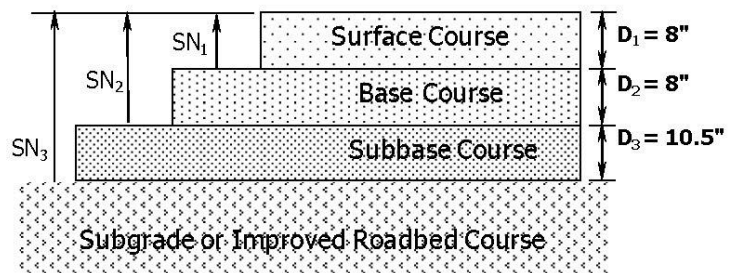

**Table 1 Axle Load Equivalency Factors for Flexible Pavements
Single Axles (Pt = 2.5)**

Axle Load (kips)	Pavement Structural Number (SN)					
	1	2	3	4	5	6
2	0.0004	0.0004	0.0003	0.0002	0.0002	0.0002
4	0.003	0.004	0.004	0.003	0.002	0.002
6	0.011	0.017	0.017	0.013	0.01	0.009
8	0.032	0.047	0.051	0.041	0.034	0.031
10	0.078	0.102	0.118	0.102	0.088	0.08
12	0.168	0.198	0.229	0.213	0.189	0.175
14	0.328	0.358	0.399	0.388	0.36	0.342
16	0.591	0.613	0.656	0.645	0.623	0.606
18	1	1	1	1	1	1
20	1.61	1.57	1.49	1.47	1.51	1.55
22	2.48	2.38	2.17	2.09	2.18	2.3
24	3.69	3.49	3.09	2.89	3.03	3.27
26	5.33	4.99	4.31	3.91	4.09	4.48
28	7.49	6.98	5.9	5.21	5.39	5.98
30	10.3	9.5	7.9	6.8	7	7.8
32	13.9	12.8	10.5	8.8	8.9	10
34	18.4	16.9	13.7	11.3	11.2	12.5
36	24	22	17.7	14.4	13.9	15.5
38	30.9	28.3	22.6	18.1	17.2	19
40	39.3	35.9	28.5	22.5	21.1	23
42	49.3	45	35.6	27.8	25.6	27.7
44	61.3	55.9	44	34	31	33.1
46	75.5	68.8	54	41.4	37.2	39.3
48	92.2	83.9	65.7	50.1	44.5	46.5
50	112	102	79	60	53	55

Lane distribution factors

Number of lanes in both directions	Percent of 18-kip ESAL traffic in design lane
1	100
2	80 - 100
3	60 - 80
4 or more	50 - 75

**Table 2 Axle Load Equivalency Factors for Flexible Pavements
Tandem Axles (Pt = 2.5)**

Axle Load (kips)	Pavement Structural Number (SN)					
	1	2	3	4	5	6
2	0.0001	0.0001	0.0001	0	0	0
4	0.0005	0.0005	0.0004	0.0003	0.0003	0.002
6	0.002	0.002	0.002	0.001	0.001	0.001
8	0.004	0.006	0.005	0.004	0.003	0.003
10	0.008	0.013	0.011	0.009	0.007	0.006
12	0.015	0.024	0.023	0.018	0.014	0.013
14	0.026	0.041	0.042	0.033	0.027	0.024
16	0.044	0.065	0.08	0.057	0.017	0.043
18	0.07	0.097	0.109	0.092	0.077	0.07
20	0.107	0.141	0.162	0.141	0.121	0.11
22	0.16	0.198	0.669	0.207	0.18	0.166
24	0.231	0.273	0.315	0.282	0.26	0.242
26	0.327	0.37	0.42	0.401	0.364	0.342
28	0.451	0.493	0.548	0.534	0.495	0.48
30	0.611	0.648	0.703	0.695	0.658	0.633
32	0.813	0.843	0.889	0.887	0.857	0.834
34	1.06	1.08	1.11	1.11	1.09	1.08
36	1.38	1.38	1.38	1.38	1.38	1.38
38	1.75	1.73	1.69	1.68	1.7	1.73
40	2.21	2.16	2.06	2.03	2.08	2.14
42	2.76	2.67	2.49	2.43	2.51	2.61
44	3.41	3.27	2.99	2.88	3	3.16
46	4.18	3.98	3.58	3.4	3.55	3.79
48	5.08	4.8	4.25	3.98	4.17	4.49
50	6.12	5.76	5.03	4.64	4.86	5.28
52	7.33	6.87	5.93	5.38	5.63	6.17
54	8.72	8.14	6.95	6.22	6.47	7.15
56	10.3	9.6	8.1	7.2	7.4	8.2
58	12.1	11.3	9.4	8.2	8.4	9.4
60	14.2	13.1	10.9	9.4	9.6	10.7
62	16.5	15.3	12.6	10.7	10.8	12.1
64	19.1	17.6	14.5	12.2	12.2	13.7
66	22.1	20.3	16.6	13.8	13.7	15.4
68	25.3	23.3	18.9	15.6	15.4	17.2
70	29	26.6	21.5	17.6	17.2	19.2
72	33	30.3	24.4	19.8	19.2	21.3
74	37.5	34.4	27.6	22.2	21.3	23.6
76	42.5	38.9	31.1	24.8	23.7	26.1
78	48	43.9	35	27.8	26.2	28.8
80	54	49.4	39.2	30.9	29	31.7
82	60.6	55.4	43.9	34.4	32	34.8
84	67.8	61.9	49	38.2	35.3	38.1
86	75.7	69.1	54.5	42.3	38.8	41.7
88	84.3	76.9	60.6	46.8	42.6	45.6
90	93.7	85.4	67.1	51.7	46.8	49.7

Rigid Pavement PCA Thickness Design Method

The PCA thickness design method considers two types of failure:

1. Fatigue failure due to tensile stress repetitions in the slab
2. Erosion failure due to repeated deflection of the slab into the foundation

A finite-element analysis of the deflections and stresses at the joints, corners, and edges of slabs revealed two things:

1. Edge loads produce the worst stresses in the pavement
2. Corner loads produce the worst deflections in the pavement

As a result, fatigue failure is analyzed based on the flexural stresses produced by edge loads and erosion failure is analyzed based on the deflections produced by corner loads. Both the fatigue and erosion analyses use Miner's cumulative damage hypothesis. The stresses or deflections produced by a given vehicle class or axle load class are used to predict the number of passages needed to fail the pavement.

The goal is to determine the slab thickness for which the pavement life consumed by the design traffic is exactly equal to 1.0 (pavement life).

Fatigue Failure

Asphalt pavements are often analyzed by assuming the pavement layers have finite thickness but infinite lateral extent. This is not a bad approximation because most of the stresses and deflections in the asphalt occur close to the wheel load; the pavement edge has little effect. In rigid pavements, the stresses are spread laterally through the slab rather than vertically into the ground, so the proximity of the wheel loads to the pavement edge significantly affects the stresses. The worst stresses are produced by contact patches located right at the edge of the pavement. As the contact patch moves into the interior, edge stresses drop off rapidly. So you can't just assume all of the trucks are at the pavement edge or well away from the pavement edge. You have to take wander into account.

By law, trucks can't be more than 8½ feet wide. Most highway lanes are 12 feet wide, so a truck centered in the lane is driving nearly 2 feet from the edge of the pavement. In other words, only a few trucks actually approach the edge of the pavement. This is especially true when the shoulder is unpaved, because drivers want to ensure they don't inadvertently run off the slab. Studies have shown that as much as 6% of trucks encroach on the pavement edge if the shoulders are paved but less than ½% encroach on the pavement edge if the shoulders are unpaved. If 100% of the trucks travel exactly at the edge of the pavement, the Westergaard edge stresses could be used directly to estimate the number of repetitions to failure, N_f . The inverse of that number is the average fatigue consumption of each vehicle. As more and more trucks move away from the edge, the average fatigue consumption decreases because the edge stresses aren't as severe as when the trucks are exactly at the pavement edge. Using finite element analyses, PCA researchers calculated the average fatigue consumption as a function of the percentage of trucks at the edge of the pavement. They then equated this average to an equivalent edge stress. In other words, what universal edge stress would produce the same amount of fatigue consumption as the mix of edge stresses produced by the wandering trucks?

Erosion Failure

Erosion failure takes into account such things as pumping, the creation of voids beneath the pavement corners, and joint faulting. These are all related more to the deflection of the slab than they are the stresses in the slab. Actually, deflection alone turned out to be a poor predictor of pavement life. A better predictor was the rate of work (i.e., work per second) done on the foundation by the deflection slab. The rate of work is proportional to the contact pressure and deflection and inversely proportional to the radius of the deflection basin (the more concentrated the load, the faster the load is applied and released as a wheel rolls over the pavement).

Curling Stresses

The PCA design method purposefully ignores stresses due to curling and/or warping (the former results from a temperature differential through the slab, the latter from a moisture differential). With regard to warping, the thinking is that most slabs are wetter on the bottom than on the top, so the slabs will want to curl upward but can't. This induces tensile stresses in the top of the slab and compressive stresses in the bottom of the slab. The compressive stresses in the bottom of the slab will offset some of the tensile stresses due to wheel loading (as in prestressed concrete) so it is conservative to ignore warping stresses. With regard to curling, the bottom of the slab is warmer than the top more hours per day than the reverse, so most of the day (except in the middle of the afternoon) the slab will want to curl up, which induces compressive stresses in the bottom of the slab that also offset some of the tensile stresses due to wheel loading. During the afternoon, the tensile curling stresses will be somewhat offset by the compressive warping stresses, reducing the need to consider them in the analysis.

Summary of PCA Design Method

- Two failure modes considered:
 - Fatigue failure due to slab flexure
 - Erosion failure due to foundation compression
- Edge loads produce the worst stresses - Fatigue based on tensile stress due to edge loads
- Corner loads produce the worst deflections - Erosion based on deflections due to corner loads

Design Parameters

1. Concrete modulus of rupture (MR)
2. Modulus of subgrade reaction (k)
3. Design traffic volume
4. Axle load spectrum

Modulus of Subgrade Reaction

Design k Values for Untreated Subbases

Subgrade k value, pci	Subbase k value, pci			
	4 in.	6 in.	9 in.	12 in.
50	65	75	85	110
100	130	140	160	190
200	220	230	270	320
300	320	330	370	430

Design k Values for Cement-Treated Subbases

Subgrade k value, pci	Subbase k value, pci			
	4 in.	6 in.	8 in.	10 in.
50	170	230	310	390
100	280	400	520	640
200	470	640	830	—

Design Traffic Volume

$$V = 365 (ADT) (T) (D) (L) (G) (Y)$$

- where, ADT = Average Daily Traffic (two-way)
 T = Percent Trucks
 D = Direction Distribution Factor
 L = Lane Distribution Factor
 G = Traffic Growth Multiplier
 Y = Design Life (Years)

Traffic Growth Multiplier

$$G = (1 + r)^{\frac{Y}{2}}$$

where, r = Annual Growth Rate

Axle Configurations

- Single axle - a single axle
- Tandem axle - two consecutive axles
- Tridem axle - three consecutive axles

Lane Distribution Factor

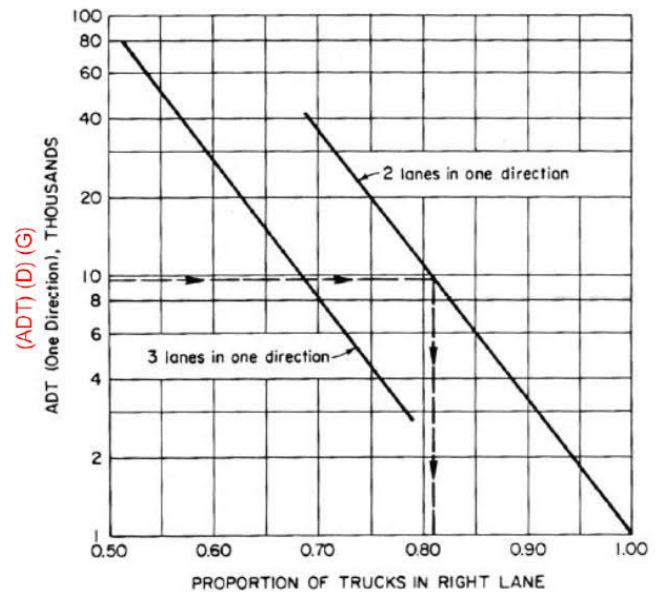

Axle Load Spectrum

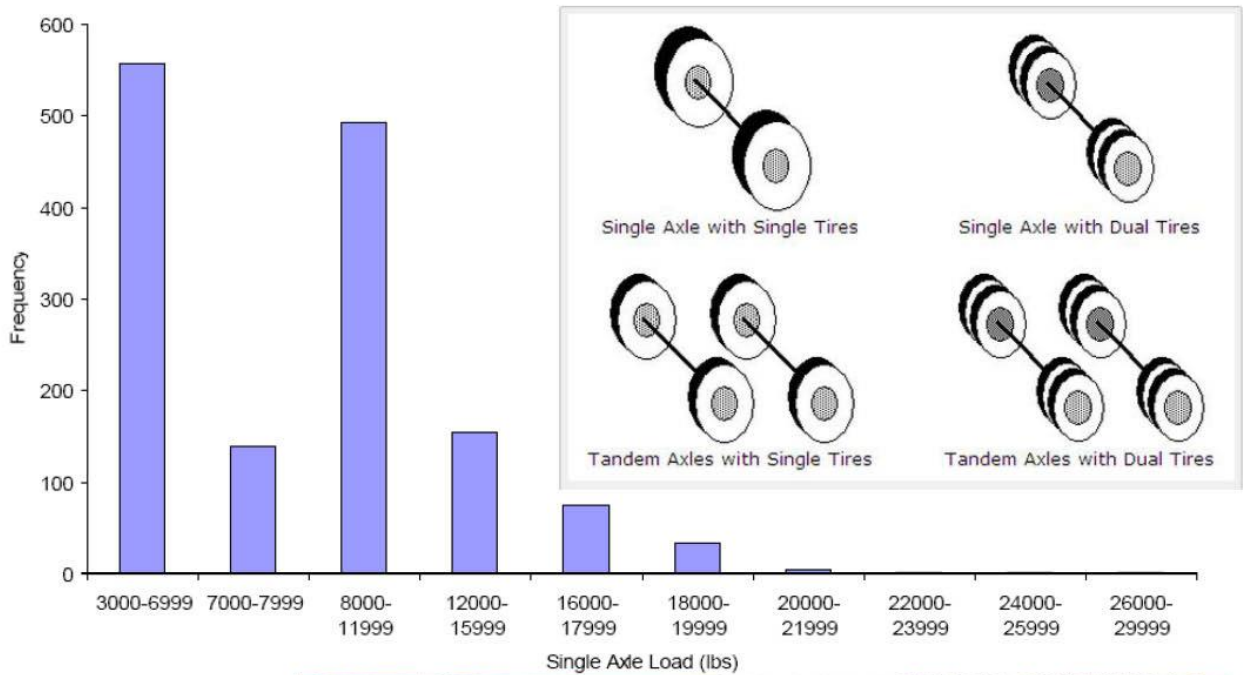

PCA Method Design Details

Based on Miner's Hypothesis: $D = \sum_i \frac{n_i}{N_i} \leq 1$

D = pavement life consumed by axle loads

n_i = actual number of axle loads in class i

N_i = axle loads needed to produce failure

Design Procedure

1. Choose a trial slab thickness (h).
2. For each axle load class:
 - a) Determine N_i for fatigue failure.
 - b) Divide n_i by N_i to determine fatigue damage factor d_i .
 - c) Determine N_i for erosion failure.
 - d) Divide n_i by N_i to determine erosion damage factor d_i .
3. Sum fatigue and erosion damage factors over all of the axle load classes.
4. If both sums are less than 1 (life) your design is good; otherwise you need to increase your slab thickness.

Example 1

Determine the design traffic volume for a four-lane rural highway having the following conditions:

ADT = 12,900 (two-way)
 T = 19%
 r = 4%
 D = 0.5 (assumed)
 Y = 20 years

Clay subgrade = 100 psi/in

Concrete MR = 650 psi

Use subbase = 4" untreated

Use Doweled JPCP & Asphalt Shoulders

Solution

Design Traffic Volume = $V = 365(ADT)(T)(D)(L)(G)(Y)$

Traffic Growth Multiplier = $G = (1 + r)^{Y/2} = (1.04)^{10} = 1.5$

Lane Distribution Factor; $(ADT)(D)(G) = (12,900)(0.5)(1.5) = 9675$

Therefore, Design Truck Traffic Volume

$V = 365 (12,900) (0.19) (0.5) (0.81) (1.5) (20)$
 $= 10,880,000$ trucks;

$V = 365 (ADT) (T) (D) (L) (G) (Y)$

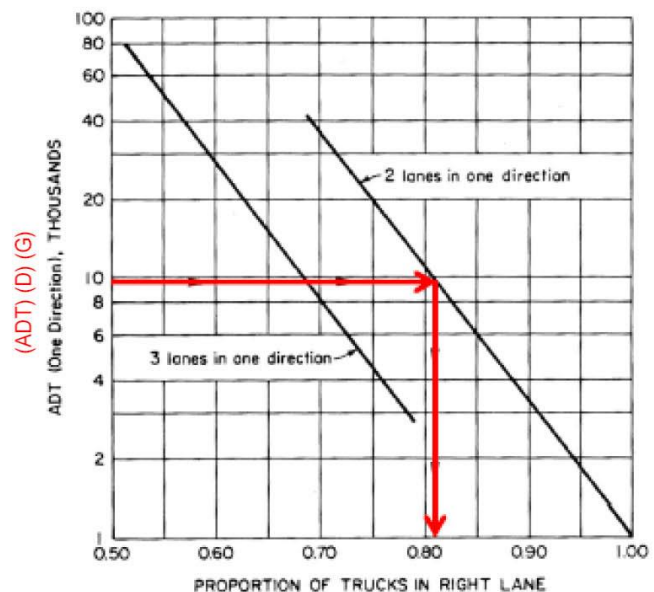

Axle Load Spectrum

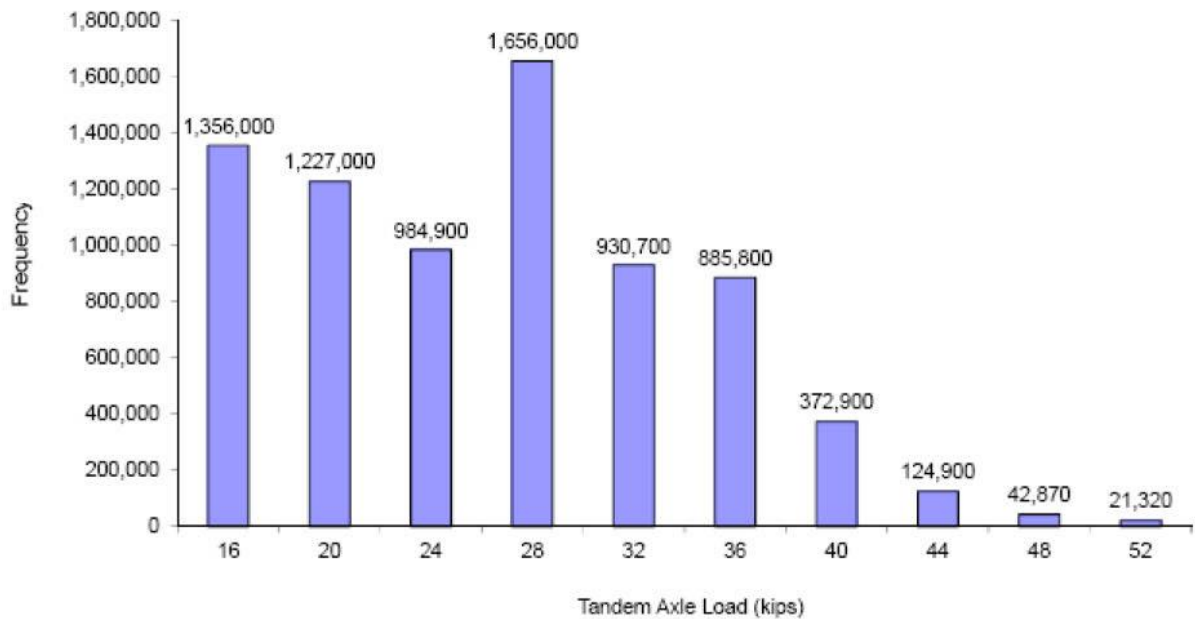
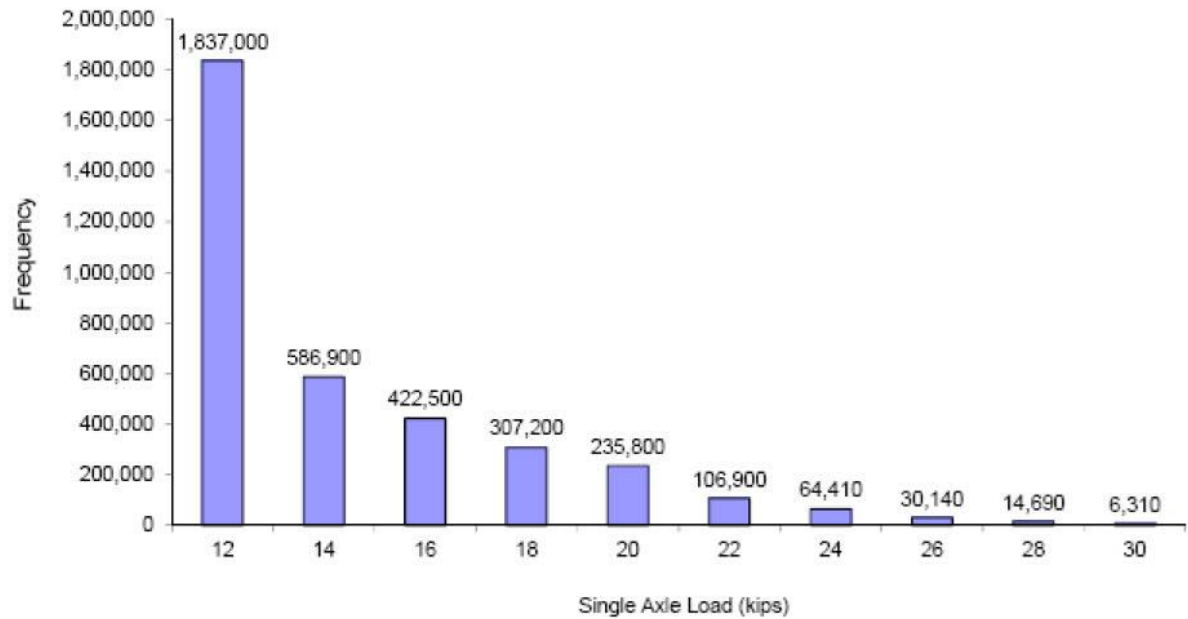

Load Safety Factor (Multiplication factor for axle loads)

Traffic Volume	LSF
High (interstates, multilane highways)	1.2
Moderate (highways and arterials)	1.1
Low (collectors, residential streets)	1.0

Calculation of Pavement Thickness

Project _____

Trial thickness _____ in Doweled joints yes _____ no _____

Subbase-subgrade, k _____ pci Concrete shoulder yes _____ no _____

Modulus of Rupture, MR _____ psi Design Period _____ years

Load safety factor, LSF _____

Axle Load, kips	Multiplied by LSF	Expected repetitions	Fatigue analysis		Erosion Analysis	
			Allowable repetitions	Fatigue Percent	Allowable repetitions	Damage Percent
1	2	3	4	5	6	7

8. Equivalent stress _____ 10. Erosion factor _____

9. Stress ratio factor _____

Single Axles

11. Equivalent stress _____ 13. Erosion factor _____

12. Stress ratio factor _____

Tandem Axles

				Total		Total

**Equivalent Stress – No Concrete Shoulder
(Single Axle / Tandem Axle)**

**Equivalent Stress – Concrete Shoulder
(Single Axle / Tandem Axle)**

Slab thickness, in.	k of subgrade-subbase, pci						
	50	100	150	200	300	500	700
4	825/679	726/585	671/542	634/516	584/486	523/457	484/443
4.5	699/586	616/500	571/460	540/435	496/406	448/378	417/363
5	602/516	531/436	493/390	467/376	432/349	390/321	363/307
5.5	526/461	464/387	431/353	409/331	379/305	343/278	320/264
6	465/416	411/348	382/316	362/296	336/271	304/246	285/232
6.5	417/380	367/317	341/286	324/267	300/244	273/220	256/207
7	375/349	331/290	307/262	292/244	271/222	246/199	231/186
7.5	340/323	300/268	279/241	265/224	246/203	224/181	210/169
8	311/300	274/249	255/223	242/208	225/188	205/167	192/155
8.5	285/281	252/232	234/208	222/193	206/174	188/154	177/143
9	264/264	232/218	216/195	205/181	190/163	174/144	163/133
9.5	245/248	215/205	200/183	190/170	176/153	161/134	151/124
10	228/235	200/193	186/173	177/160	164/144	150/126	141/117
10.5	213/222	187/183	174/164	165/151	153/136	140/119	132/110
11	200/211	175/174	163/155	154/143	144/129	131/113	123/104
11.5	188/201	165/165	153/148	145/136	135/122	123/107	116/98
12	177/192	155/158	144/141	137/130	127/116	116/102	109/93
12.5	168/183	147/151	136/135	129/124	120/111	109/97	103/89
13	159/176	139/144	129/129	122/119	113/106	103/93	97/85
13.5	152/168	132/138	122/123	116/114	107/102	98/89	92/81
14	144/162	125/133	116/118	110/109	102/98	93/85	86/78

Slab thickness, in.	k of subgrade-subbase, pci						
	50	100	150	200	300	500	700
4	640/534	559/468	517/439	489/422	452/403	409/388	383/384
4.5	547/461	479/400	444/372	421/356	390/338	355/322	333/316
5	475/404	417/349	387/323	367/308	341/290	311/274	294/267
5.5	418/360	368/309	342/285	324/271	302/254	276/238	261/231
6	372/325	327/277	304/255	289/241	270/225	247/210	234/203
6.5	334/295	294/251	274/230	260/218	243/203	223/188	212/180
7	302/270	266/230	248/210	236/198	220/184	203/170	192/162
7.5	275/250	243/211	226/193	215/182	201/168	185/155	176/148
8	252/232	222/196	207/179	197/168	185/155	170/142	162/135
8.5	232/216	205/182	191/166	182/156	170/144	157/131	150/125
9	215/202	190/171	177/155	169/146	158/134	146/122	139/116
9.5	200/190	176/160	164/146	157/137	147/126	136/114	129/108
10	186/179	164/151	153/137	146/129	137/118	127/107	121/101
10.5	174/170	154/143	144/130	137/121	128/111	119/101	113/95
11	164/161	144/135	135/123	129/115	120/105	112/95	106/90
11.5	154/153	136/128	127/117	121/109	113/100	105/90	100/85
12	145/146	128/122	120/111	114/104	107/95	99/86	95/81
12.5	137/139	121/117	113/106	108/99	101/91	94/82	90/77
13	130/133	115/112	107/101	102/95	96/86	89/78	85/73
13.5	124/127	109/107	102/97	97/91	91/83	85/74	81/70
14	118/122	104/103	97/93	93/87	87/79	81/71	77/67

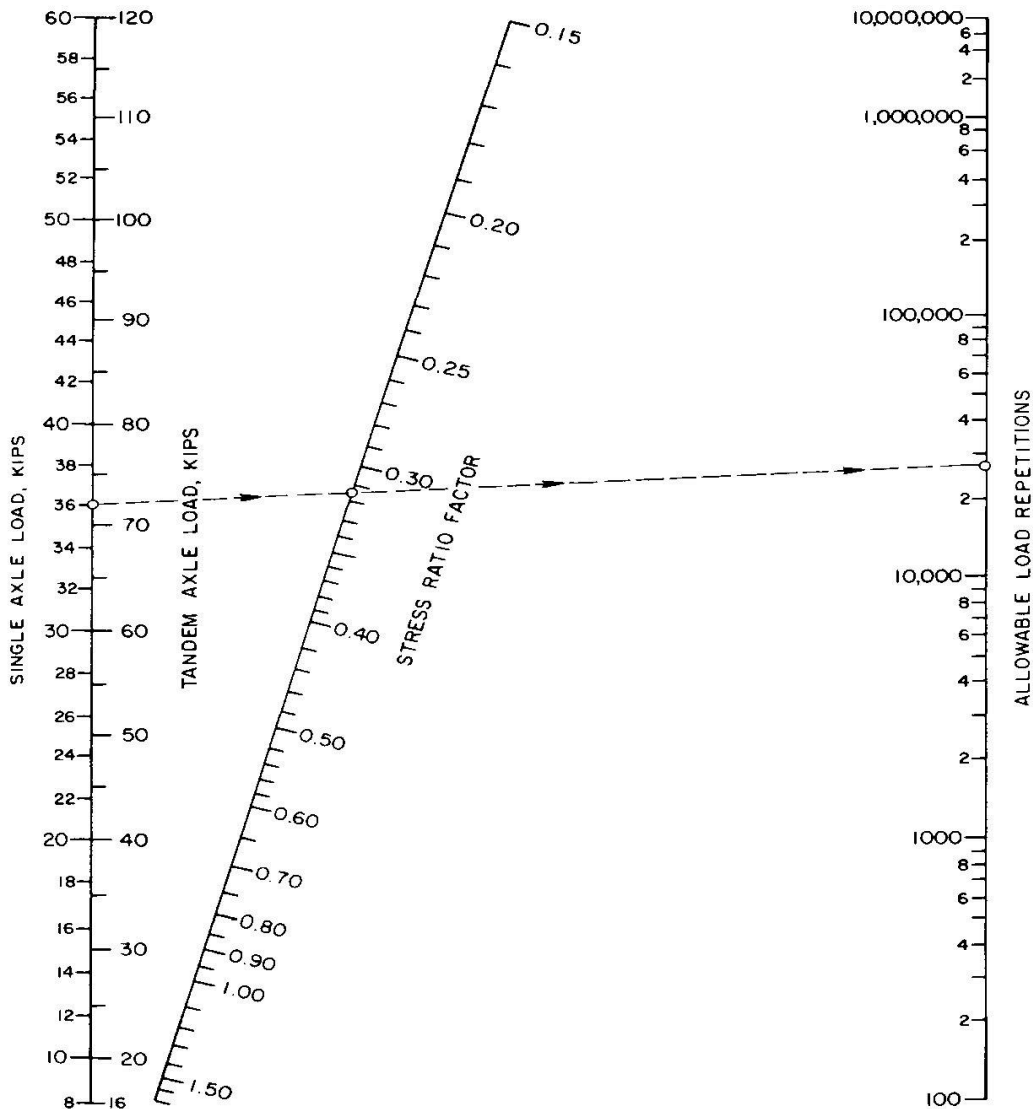

Fatigue analysis—allowable load repetitions based on stress ratio factor (with & without concrete shoulder)

Calculation of Pavement Thickness

Project Design 1 - Four-lane rural interstate, dowels, asphalt shoulder
 Trial thickness 9.5 in. Doweled joints: yes X no
 Subbase-subgrade k 130 pci Concrete shoulder: yes no X
 Modulus of rupture, MR 650 psi Design period 20 years
 Load safety factor, LSF 1.2

Axle load, kips	Multiplied by LSF	Expected repetitions	Fatigue analysis		Erosion analysis	
			Allowable repetitions	Fatigue, percent	Allowable repetitions	Damage, percent
1	2	3	4	5	6	7

8. Equivalent stress 206 10. Erosion factor
 9. Stress ratio factor 0.317

Single Axles

30	36.0	6310	27,000	23.4		

Calculation of Pavement Thickness

Project Design 1 - Four-lane rural interstate, dowels, asphalt shoulder
 Trial thickness 9.5 in. Doweled joints: yes X no
 Subbase-subgrade k 130 pci Concrete shoulder: yes no X
 Modulus of rupture, MR 650 psi Design period 20 years
 Load safety factor, LSF 1.2

Axle load, kips	Multiplied by LSF	Expected repetitions	Fatigue analysis		Erosion analysis	
			Allowable repetitions	Fatigue, percent	Allowable repetitions	Damage, percent
1	2	3	4	5	6	7

8. Equivalent stress 206 10. Erosion factor
 9. Stress ratio factor 0.317

Single Axles

30	36.0	6310	27,000	23.4		
28	33.6	14,690	77,000	19.1		
26	31.2	30,140	230,000	13.1		
24	28.8	64,410	1,200,000	5.4		
22	26.4	106,900				

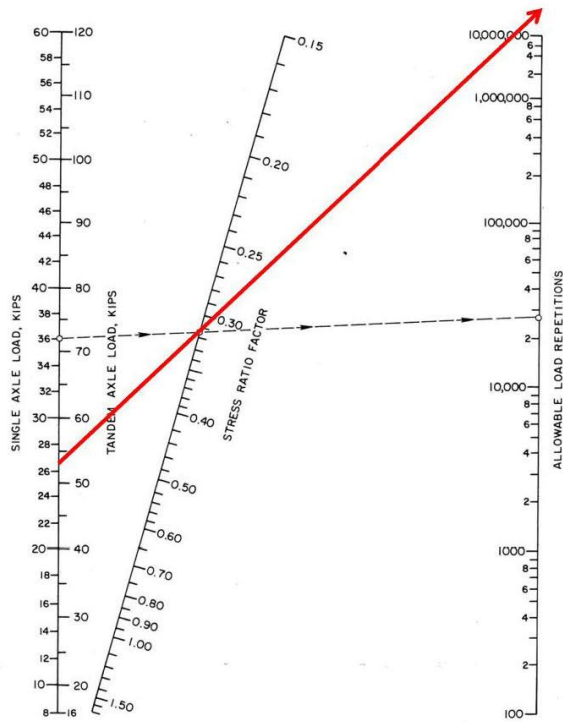

Fig. 5. Fatigue analysis—allowable load repetitions based on stress ratio factor (with and without concrete shoulder).

Calculation of Pavement Thickness

Project Design 1 - Four-lane rural interstate, dowels, asphalt shoulder
 Trial thickness 9.5 in. Doweled joints: yes X no
 Subbase-subgrade k 130 pci Concrete shoulder: yes no X
 Modulus of rupture, MR 650 psi Design period 20 years
 Load safety factor, LSF 1.2

Axle load, kips	Multiplied by LSF	Expected repetitions	Fatigue analysis		Erosion analysis	
			Allowable repetitions	Fatigue, percent	Allowable repetitions	Damage, percent
1	2	3	4	5	6	7

8. Equivalent stress 206 10. Erosion factor
 9. Stress ratio factor 0.317

Single Axles

30	36.0	6310	27,000	23.4		
28	33.6	14,690	77,000	19.1		
26	31.2	30,140	230,000	13.1		
24	28.8	64,410	1,200,000	5.4		
22	26.4	106,900	unlimited	0.0		
				$\Sigma = 61.0$		

Calculation of Pavement Thickness

Project Design 1 - Four-lane rural interstate, dowels, asphalt shoulder
 Trial thickness 9.5 in. Doweled joints: yes X no
 Subbase-subgrade k 130 pci Concrete shoulder: yes no X
 Modulus of rupture, MR 650 psi Design period 20 years
 Load safety factor, LSF 1.2

Axle load, kips	Multiplied by LSF	Expected repetitions	Fatigue analysis		Erosion analysis	
			Allowable repetitions	Fatigue, percent	Allowable repetitions	Damage, percent
1	2	3	4	5	6	7

11. Equivalent stress 192 13. Erosion factor
 12. Stress ratio factor 0.295 ← 192/MR

Tandem Axles

<u>52</u>	<u>62.4</u>	<u>21,320</u>				

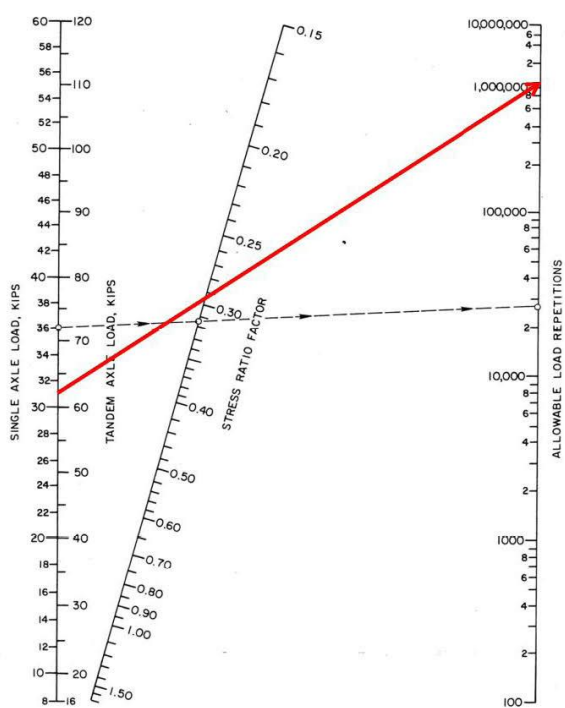

Fig. 5. Fatigue analysis—allowable load repetitions based on stress ratio factor (with and without concrete shoulder).

Calculation of Pavement Thickness

Project Design 1 - Four-lane rural interstate, dowels, asphalt shoulder
 Trial thickness 9.5 in. Doweled joints: yes X no
 Subbase-subgrade k 130 pci Concrete shoulder: yes no X
 Modulus of rupture, MR 650 psi Design period 20 years
 Load safety factor, LSF 1.2

Axle load, kips	Multiplied by LSF	Expected repetitions	Fatigue analysis		Erosion analysis	
			Allowable repetitions	Fatigue, percent	Allowable repetitions	Damage, percent
1	2	3	4	5	6	7

11. Equivalent stress 192 13. Erosion factor
 12. Stress ratio factor 0.295

Tandem Axles

52	62.4	21,320	1,100,000	1.9		

Calculation of Pavement Thickness

Project Design 1 - Four-lane rural interstate, dowels, asphalt shoulder
 Trial thickness 9.5 in. Doweled joints: yes X no
 Subbase-subgrade k 130 pci Concrete shoulder: yes no X
 Modulus of rupture, MR 650 psi Design period 20 years
 Load safety factor, LSF 1.2

Axle load, kips	Multiplied by LSF	Expected repetitions	Fatigue analysis		Erosion analysis	
			Allowable repetitions	Fatigue, percent	Allowable repetitions	Damage, percent
1	2	3	4	5	6	7

11. Equivalent stress 192 13. Erosion factor
 12. Stress ratio factor 0.295

Tandem Axles

52	62.4	21,320	1,100,000	1.9		
48	57.6	42,870				

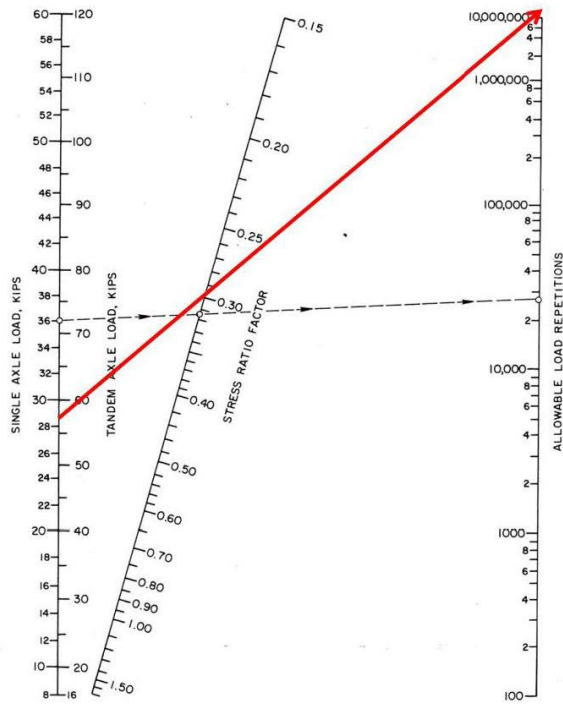

Fig. 5. Fatigue analysis—allowable load repetitions based on stress ratio factor (with and without concrete shoulder).

Calculation of Pavement Thickness

Project Design 1 - Four-lane rural interstate, dowels, asphalt shoulder
 Trial thickness 9.5 in. Doweled joints: yes no
 Subbase-subgrade k 130 pci Concrete shoulder: yes no
 Modulus of rupture, MR 650 psi Design period 20 years
 Load safety factor, LSF 1.2

Axle load, kips	Multiplied by LSF	Expected repetitions	Fatigue analysis		Erosion analysis	
			Allowable repetitions	Fatigue, percent	Allowable repetitions	Damage, percent
1	2	3	4	5	6	7

11. Equivalent stress 192 13. Erosion factor _____
 12. Stress ratio factor 0.295

Tandem Axles

52	62.4	21,320	1,100,000	1.9		
48	57.6	42,870	unlimited	0.0		
				$\Sigma = 62.9$		

Calculation of Pavement Thickness

Project Design 1 - Four-lane rural interstate, dowels, asphalt shoulder

Trial thickness 9.5 in. Doweled joints: yes no
 Subbase-subgrade k 130 pci Concrete shoulder: yes no
 Modulus of rupture, MR 650 psi Design period 20 years
 Load safety factor, LSF 1.2

Axle load, kips	Multiplied by LSF	Expected repetitions	Fatigue analysis		Erosion analysis	
			Allowable repetitions	Fatigue, percent	Allowable repetitions	Damage, percent
1	2	3	4	5	6	7

8. Equivalent stress 206 10. Erosion factor _____
 9. Stress ratio factor 0.317 ← 206/MR

Single Axles

30	36.0	6310	27,000	23.4		
28	33.6	14,690	77,000	19.1		
26	31.2	30,140	230,000	13.1		
24	28.8	64,410	1,200,000	5.4		
22	26.4	106,900	unlimited	0.0		
				$\Sigma = 61.0$		

11. Equivalent stress 192 13. Erosion factor _____
 12. Stress ratio factor 0.295

Tandem Axles

52	62.4	21,320	1,100,000	1.9		
48	57.6	42,870	unlimited	0.0		
				$\Sigma = 62.9$		

Erosion Factor

Erosion Factor – Doweled Joints, Concrete Shoulder (Single Axle / Tandem Axle)

Slab thickness, in.	k of subgrade-subbase, pci					
	50	100	200	300	500	700
4	3.28/3.30	3.24/3.20	3.21/3.13	3.19/3.10	3.15/3.09	3.12/3.08
4.5	3.13/3.19	3.09/3.08	3.06/3.00	3.04/2.96	3.01/2.93	2.98/2.91
5	3.01/3.09	2.97/2.98	2.93/2.89	2.90/2.84	2.87/2.79	2.85/2.77
5.5	2.90/3.01	2.85/2.89	2.81/2.79	2.79/2.74	2.76/2.68	2.73/2.65
6	2.79/2.93	2.75/2.82	2.70/2.71	2.68/2.65	2.65/2.58	2.62/2.54
6.5	2.70/2.86	2.65/2.75	2.61/2.63	2.58/2.57	2.55/2.50	2.52/2.45
7	2.61/2.79	2.56/2.68	2.52/2.56	2.49/2.50	2.46/2.42	2.43/2.38
7.5	2.53/2.73	2.48/2.62	2.44/2.50	2.41/2.44	2.38/2.36	2.35/2.31
8	2.46/2.68	2.41/2.56	2.36/2.44	2.33/2.38	2.30/2.30	2.27/2.24
8.5	2.39/2.62	2.34/2.51	2.29/2.39	2.26/2.32	2.22/2.24	2.20/2.18
9	2.32/2.57	2.27/2.46	2.22/2.34	2.19/2.27	2.16/2.19	2.13/2.13
9.5	2.26/2.52	2.21/2.41	2.16/2.29	2.13/2.22	2.09/2.14	2.07/2.08
10	2.20/2.47	2.15/2.36	2.10/2.25	2.07/2.18	2.03/2.09	2.01/2.03
10.5	2.15/2.43	2.09/2.32	2.04/2.20	2.01/2.14	1.97/2.05	1.95/1.99
11	2.10/2.39	2.04/2.28	1.99/2.16	1.95/2.09	1.92/2.01	1.89/1.95
11.5	2.05/2.35	1.99/2.24	1.93/2.12	1.90/2.05	1.87/1.97	1.84/1.91
12	2.00/2.31	1.94/2.20	1.88/2.09	1.85/2.02	1.82/1.93	1.79/1.87
12.5	1.95/2.27	1.89/2.16	1.84/2.05	1.81/1.98	1.77/1.89	1.74/1.84
13	1.91/2.23	1.85/2.13	1.79/2.01	1.76/1.95	1.72/1.86	1.70/1.80
13.5	1.86/2.20	1.81/2.09	1.75/1.98	1.72/1.91	1.68/1.83	1.65/1.77
14	1.82/2.17	1.76/2.06	1.71/1.95	1.67/1.88	1.64/1.80	1.61/1.74

Erosion Factor – No Dowels, Concrete Shoulder (Single Axle / Tandem Axle)

Slab thickness, in.	k of subgrade-subbase, pci					
	50	100	200	300	500	700
4	3.46/3.49	3.42/3.39	3.38/3.32	3.36/3.29	3.32/3.26	3.28/3.24
4.5	3.32/3.39	3.28/3.28	3.24/3.19	3.22/3.16	3.19/3.12	3.15/3.09
5	3.20/3.30	3.16/3.18	3.12/3.09	3.10/3.05	3.07/3.00	3.04/2.97
5.5	3.10/3.22	3.05/3.10	3.01/3.00	2.99/2.95	2.96/2.90	2.93/2.86
6	3.00/3.15	2.95/3.02	2.90/2.92	2.88/2.87	2.86/2.81	2.83/2.77
6.5	2.91/3.08	2.86/2.96	2.81/2.85	2.79/2.79	2.76/2.73	2.74/2.68
7	2.83/3.02	2.77/2.90	2.73/2.78	2.70/2.72	2.68/2.66	2.65/2.61
7.5	2.76/2.97	2.70/2.84	2.65/2.72	2.62/2.66	2.60/2.59	2.57/2.54
8	2.69/2.92	2.63/2.79	2.57/2.67	2.55/2.61	2.52/2.53	2.50/2.48
8.5	2.63/2.88	2.56/2.74	2.51/2.62	2.48/2.55	2.45/2.48	2.43/2.43
9	2.57/2.83	2.50/2.70	2.44/2.57	2.42/2.51	2.39/2.43	2.36/2.38
9.5	2.51/2.79	2.44/2.65	2.38/2.53	2.36/2.46	2.33/2.38	2.30/2.33
10	2.46/2.75	2.39/2.61	2.33/2.49	2.30/2.42	2.27/2.34	2.24/2.28
10.5	2.41/2.72	2.33/2.58	2.27/2.45	2.24/2.38	2.21/2.30	2.19/2.24
11	2.36/2.68	2.28/2.54	2.22/2.41	2.19/2.34	2.16/2.26	2.14/2.20
11.5	2.32/2.65	2.24/2.51	2.17/2.38	2.14/2.31	2.11/2.22	2.09/2.16
12	2.28/2.62	2.19/2.48	2.13/2.34	2.10/2.27	2.06/2.19	2.04/2.13
12.5	2.24/2.59	2.15/2.45	2.09/2.31	2.05/2.24	2.02/2.15	1.99/2.10
13	2.20/2.56	2.11/2.42	2.04/2.28	2.01/2.21	1.98/2.12	1.95/2.06
13.5	2.16/2.53	2.08/2.39	2.00/2.25	1.97/2.18	1.93/2.09	1.91/2.03
14	2.13/2.51	2.04/2.36	1.97/2.23	1.93/2.15	1.89/2.06	1.87/2.00

Erosion Factor – Doweled Joints, No Concrete Shoulder (Single Axle / Tandem Axle)

Slab thickness, in.	k of subgrade-subbase, pci					
	50	100	200	300	500	700
4	3.74/3.83	3.73/3.79	3.72/3.75	3.71/3.73	3.70/3.70	3.68/3.67
4.5	3.59/3.70	3.57/3.65	3.56/3.61	3.55/3.58	3.54/3.55	3.52/3.53
5	3.45/3.58	3.43/3.52	3.42/3.48	3.41/3.45	3.40/3.42	3.38/3.40
5.5	3.33/3.47	3.31/3.41	3.29/3.36	3.28/3.33	3.27/3.30	3.26/3.28
6	3.22/3.38	3.19/3.31	3.18/3.26	3.17/3.23	3.15/3.20	3.14/3.17
6.5	3.11/3.29	3.09/3.22	3.07/3.16	3.06/3.13	3.05/3.10	3.03/3.07
7	3.02/3.21	2.99/3.14	2.97/3.08	2.96/3.05	2.95/3.01	2.94/2.98
7.5	2.93/3.14	2.91/3.06	2.88/3.00	2.87/2.97	2.86/2.93	2.84/2.90
8	2.85/3.07	2.82/2.99	2.80/2.93	2.79/2.89	2.77/2.85	2.76/2.82
8.5	2.77/3.01	2.74/2.93	2.72/2.86	2.71/2.82	2.69/2.78	2.68/2.75
9	2.70/2.96	2.67/2.87	2.65/2.80	2.63/2.76	2.62/2.71	2.61/2.68
9.5	2.63/2.90	2.60/2.81	2.58/2.74	2.56/2.70	2.55/2.65	2.54/2.62
10	2.56/2.85	2.54/2.76	2.51/2.68	2.50/2.64	2.48/2.59	2.47/2.56
10.5	2.50/2.81	2.47/2.71	2.45/2.63	2.44/2.59	2.42/2.54	2.41/2.51
11	2.44/2.76	2.42/2.67	2.39/2.58	2.38/2.54	2.36/2.49	2.35/2.45
11.5	2.38/2.72	2.36/2.62	2.33/2.54	2.32/2.49	2.30/2.44	2.29/2.40
12	2.33/2.68	2.30/2.58	2.26/2.49	2.26/2.44	2.25/2.39	2.23/2.36
12.5	2.28/2.64	2.25/2.54	2.23/2.45	2.21/2.40	2.19/2.35	2.18/2.31
13	2.23/2.61	2.20/2.50	2.18/2.41	2.16/2.36	2.14/2.30	2.13/2.27
13.5	2.18/2.57	2.15/2.47	2.13/2.37	2.11/2.32	2.09/2.26	2.08/2.23
14	2.13/2.54	2.11/2.43	2.08/2.34	2.07/2.29	2.05/2.23	2.03/2.19

Erosion Factor – No Dowels, No Concrete Shoulder (Single Axle / Tandem Axle)

Slab thickness, in.	k of subgrade-subbase, pci					
	50	100	200	300	500	700
4	3.94/4.03	3.91/3.95	3.88/3.89	3.86/3.86	3.82/3.83	3.77/3.80
4.5	3.79/3.91	3.76/3.82	3.73/3.75	3.71/3.72	3.68/3.68	3.64/3.65
5	3.66/3.81	3.63/3.72	3.60/3.64	3.58/3.60	3.55/3.55	3.52/3.52
5.5	3.54/3.72	3.51/3.62	3.48/3.53	3.46/3.49	3.43/3.44	3.41/3.40
6	3.44/3.64	3.40/3.53	3.37/3.44	3.35/3.40	3.32/3.34	3.30/3.30
6.5	3.34/3.56	3.30/3.46	3.26/3.36	3.25/3.31	3.22/3.25	3.20/3.21
7	3.26/3.49	3.21/3.39	3.17/3.29	3.15/3.24	3.13/3.17	3.11/3.13
7.5	3.18/3.43	3.13/3.32	3.09/3.22	3.07/3.17	3.04/3.10	3.02/3.06
8	3.11/3.37	3.05/3.26	3.01/3.16	2.99/3.10	2.96/3.03	2.94/2.99
8.5	3.04/3.32	2.98/3.21	2.93/3.10	2.91/3.04	2.88/2.97	2.87/2.93
9	2.98/3.27	2.91/3.16	2.86/3.05	2.84/2.99	2.81/2.92	2.79/2.87
9.5	2.92/3.22	2.85/3.11	2.80/3.00	2.77/2.94	2.75/2.86	2.73/2.81
10	2.86/3.18	2.79/3.06	2.74/2.95	2.71/2.89	2.68/2.81	2.66/2.76
10.5	2.81/3.14	2.74/3.02	2.68/2.91	2.65/2.84	2.62/2.76	2.60/2.72
11	2.77/3.10	2.69/2.98	2.63/2.86	2.60/2.80	2.57/2.72	2.54/2.67
11.5	2.72/3.06	2.64/2.94	2.58/2.82	2.55/2.76	2.51/2.68	2.49/2.63
12	2.68/3.03	2.60/2.90	2.53/2.78	2.50/2.72	2.48/2.64	2.44/2.59
12.5	2.64/2.99	2.55/2.87	2.48/2.75	2.45/2.68	2.41/2.60	2.39/2.55
13	2.60/2.96	2.51/2.83	2.44/2.71	2.40/2.65	2.36/2.56	2.34/2.51
13.5	2.56/2.93	2.47/2.80	2.40/2.68	2.36/2.61	2.32/2.53	2.30/2.48
14	2.53/2.90	2.44/2.77	2.36/2.65	2.32/2.58	2.28/2.50	2.25/2.44

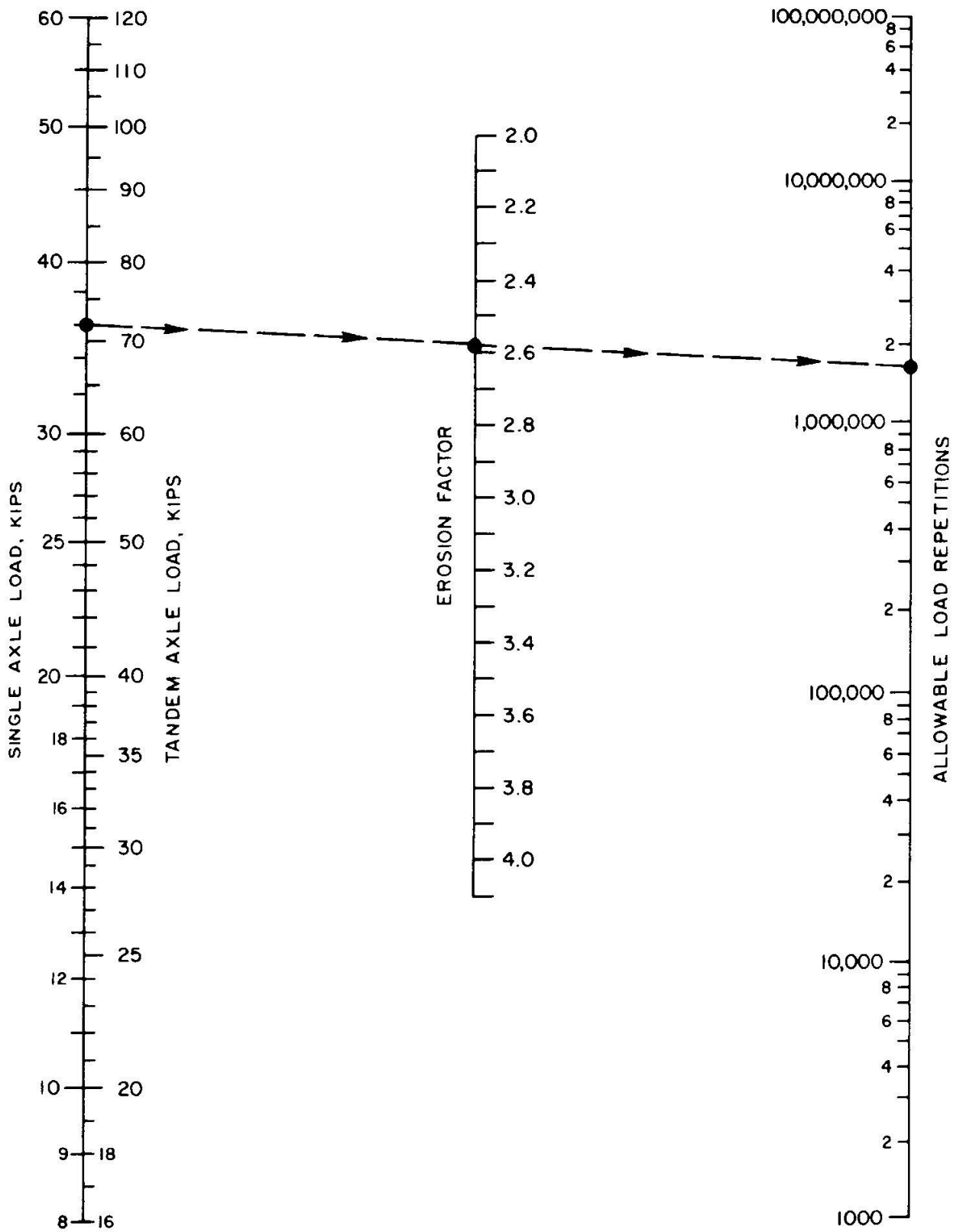

Erosion analysis—allowable load repetitions based on erosion factor (without concrete shoulder)

Calculation of Pavement Thickness

Project Design 1 - Four-lane rural interstate, dowels, asphalt shoulder
 Trial thickness 9.5 in. Doweled joints: yes X no
 Subbase-subgrade k 130 pci Concrete shoulder: yes no X
 Modulus of rupture, MR 650 psi Design period 20 years
 Load safety factor, LSF 1.2

Axle load, kips	Multiplied by LSF	Expected repetitions	Fatigue analysis		Erosion analysis	
			Allowable repetitions	Fatigue, percent	Allowable repetitions	Damage, percent
1	2	3	4	5	6	7

8. Equivalent stress 206 10. Erosion factor 2.59
 9. Stress ratio factor 0.317

Single Axles

30	36.0	6310	27,000	23.4		
28	33.6	14,690	77,000	19.1		
26	31.2	30,140	230,000	13.1		
24	28.8	64,410	1,200,000	5.4		
22	26.4	106,900	unlimited	0.0		

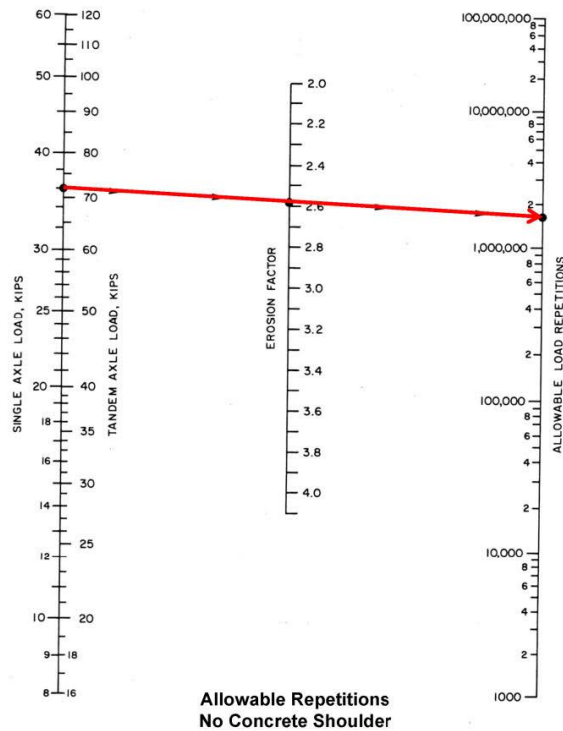

Calculation of Pavement Thickness

Project Design 1 - Four-lane rural interstate, dowels, asphalt shoulder
 Trial thickness 9.5 in. Doweled joints: yes no
 Subbase-subgrade k 130 pci Concrete shoulder: yes no
 Modulus of rupture, MR 650 psi Design period 20 years
 Load safety factor, LSF 1.2

Axle load, kips	Multiplied by LSF	Expected repetitions	Fatigue analysis		Erosion analysis	
			Allowable repetitions	Fatigue, percent	Allowable repetitions	Damage, percent
1	2	3	4	5	6	7

8. Equivalent stress 206 10. Erosion factor 2.59
 9. Stress ratio factor 0.317

Single Axles

30	36.0	6310	27,000	23.4	1,500,000	0.4
28	33.6	14,690	77,000	19.1		
26	31.2	30,140	230,000	13.1		
24	28.8	64,410	1,200,000	5.4		
22	26.4	106,900	unlimited	0.0		

Calculation of Pavement Thickness

Project Design 1 - Four-lane rural interstate, dowels, asphalt shoulder
 Trial thickness 9.5 in. Doweled joints: yes no
 Subbase-subgrade k 130 pci Concrete shoulder: yes no
 Modulus of rupture, MR 650 psi Design period 20 years
 Load safety factor, LSF 1.2

Axle load, kips	Multiplied by LSF	Expected repetitions	Fatigue analysis		Erosion analysis	
			Allowable repetitions	Fatigue, percent	Allowable repetitions	Damage, percent
1	2	3	4	5	6	7

8. Equivalent stress 206 10. Erosion factor 2.59
 9. Stress ratio factor 0.317

Single Axles

30	36.0	6310	27,000	23.4	1,500,000	0.4
28	33.6	14,690	77,000	19.1	2,200,000	0.7
26	31.2	30,140	230,000	13.1	3,500,000	0.9
24	28.8	64,410	1,200,000	5.4	5,900,000	1.1
22	26.4	106,900	unlimited	0.0	11,000,000	1.0
					23,000,000	1.0
					64,000,000	0.5
					unlimited	0
						$\Sigma = 6.1$

Calculation of Pavement Thickness

Project Design 1 - Four-lane rural interstate, dowels, asphalt shoulder
 Trial thickness 9.5 in. Doweled joints: yes X no
 Subbase-subgrade k 130 pci Concrete shoulder: yes no X
 Modulus of rupture, MR 650 psi Design period 20 years
 Load safety factor, LSF 1.2

Axle load, kips	Multiplied by LSF	Expected repetitions	Fatigue analysis		Erosion analysis	
			Allowable repetitions	Fatigue, percent	Allowable repetitions	Damage, percent
1	2	3	4	5	6	7

11. Equivalent stress 192 13. Erosion factor 2.79
 12. Stress ratio factor 0.295

Tandem Axles

52	62.4	21,320	1,100,000	1.9		
48	57.6	42,870	unlimited	0.0		

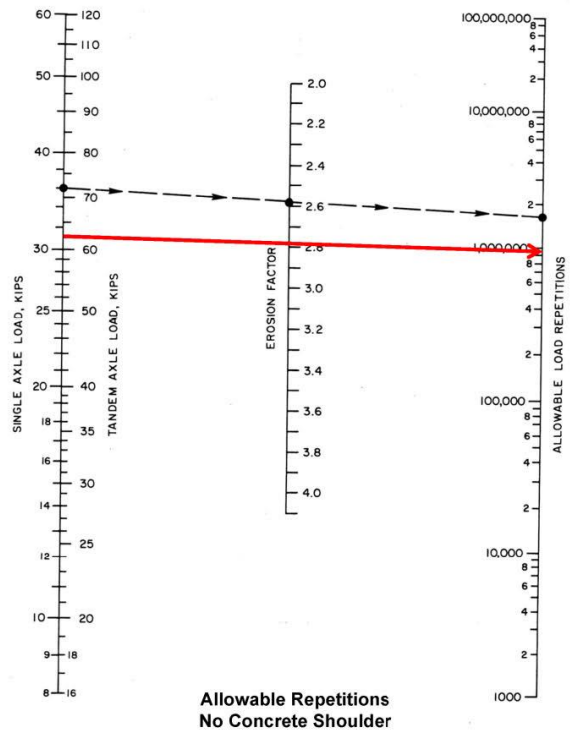

Calculation of Pavement Thickness

Project Design 1 - Four-lane rural interstate, dowels, asphalt shoulder

Trial thickness 9.5 in. Doweled joints: yes X no
 Subbase-subgrade k 130 pci Concrete shoulder: yes no X
 Modulus of rupture, MR 650 psi Design period 20 years
 Load safety factor, LSF 1.2

Axle load, kips	Multiplied by LSF	Expected repetitions	Fatigue analysis		Erosion analysis	
			Allowable repetitions	Fatigue, percent	Allowable repetitions	Damage, percent
1	2	3	4	5	6	7

11. Equivalent stress 192 13. Erosion factor 2.79
 12. Stress ratio factor 0.295

Tandem Axles

52	62.4	21,320	1,100,000	1.9	920,000	2.3
48	57.6	42,870	unlimited	0.0		

Calculation of Pavement Thickness

Project Design 1 - Four-lane rural interstate, dowels, asphalt shoulder

Trial thickness 9.5 in. Doweled joints: yes X no
 Subbase-subgrade k 130 pci Concrete shoulder: yes no X
 Modulus of rupture, MR 650 psi Design period 20 years
 Load safety factor, LSF 1.2

Axle load, kips	Multiplied by LSF	Expected repetitions	Fatigue analysis		Erosion analysis	
			Allowable repetitions	Fatigue, percent	Allowable repetitions	Damage, percent
1	2	3	4	5	6	7

11. Equivalent stress 192 13. Erosion factor 2.79
 12. Stress ratio factor 0.295

Tandem Axles

52	62.4	21,320	1,100,000	1.9	920,000	2.3
48	57.6	42,870	unlimited	0.0	1,500,000	2.9
44	52.8	124,900			2,500,000	5.0
40	48.0	372,900			4,600,000	8.1
36	43.2	885,800			9,500,000	9.3
32	38.4	930,700			24,000,000	3.9
28	33.6	1,656,000			92,000,000	1.8
24	28.8	984,900			unlimited	0.0
						Σ = 33.3

Calculation of Pavement Thickness

Project Design 1 - Four-lane rural interstate, dowels, asphalt shoulder

Trial thickness 9.5 in. Doweled joints: yes no
 Subbase-subgrade k 130 pci Concrete shoulder: yes no
 Modulus of rupture, MR 650 psi Design period 20 years
 Load safety factor, LSF 1.2

Axle load, kips	Multiplied by LSF	Expected repetitions	Fatigue analysis		Erosion analysis	
			Allowable repetitions	Fatigue, percent	Allowable repetitions	Damage, percent
1	2	3	4	5	6	7

8. Equivalent stress 206 10. Erosion factor 2.59
 9. Stress ratio factor 0.317

Single Axles

30	36.0	6310	27,000	23.4	1,500,000	0.4
28	33.6	14,690	77,000	19.1	2,200,000	0.7
26	31.2	30,140	230,000	13.1	3,500,000	0.9
24	28.8	64,410	1,200,000	5.4	5,900,000	1.1
22	26.4	106,900	unlimited	0.0	11,000,000	1.0
					23,000,000	1.0
					64,000,000	0.5
					unlimited	0
						$\Sigma = 5.6$

11. Equivalent stress 192 13. Erosion factor 2.79
 12. Stress ratio factor 0.295

Tandem Axles

52	62.4	21,320	1,100,000	1.9	920,000	2.3
48	57.6	42,870	unlimited	0.0	1,500,000	2.9
44	52.8	124,900			2,500,000	5.0
40	48.0	372,900			4,600,000	8.1
36	43.2	885,800			9,500,000	9.3
32	38.4	930,700			24,000,000	3.9
28	33.6	1,656,000			92,000,000	1.8
24	28.8	984,900			unlimited	0.0
						$\Sigma = 33.3$

Comments:

First trial with t = 9.5 in
 Total Fatigue & Damage = Fatigue % + Damage % = 62.9 + 38.9 = 101.80%; **which is acceptable.**
So, design thickness, t = 9.5 in.

Notes:

- If total fatigue and damage was << 100%; which would have implied that the assumed thickness was over-estimated. As such, 2nd trial would have been needed with reduced thickness. OR
- If total fatigue and damage was >>100%; which would have implied that the assumed thickness was under-estimated. As such, 2nd trial would have been needed with increased thickness.

Example 2

Design the thickness of a concrete pavement using PCA method for the conditions given below:

General Data

Traffic (Average Daily Traffic, ADT):	400 veh/day (both directions)
Trucks:	20 percent of ADT
Annual growth:	3 percent
Modulus of Rupture, M_R :	650 psi
Modulus of Subgrade Reaction, k :	100 pci
Design life:	20 years

Truck Axle Distributions

Axle Load Group (kips)	No. axles per 100 trucks on the road	
	Single Axles	Tandem Axles
12-14	8.0	
14-16	7.3	
16-18	6.1	
18-20	5.4	
20-22	3.2	
22-24		7.6
24-26		8.4
26-28		9.0
28-30		11.2
30-32		9.4
32-34		1.8
34-36		1.4
36-38		0.9
38-40		1.0
40-42		0.1
42-44		0.1
44-46		0.1

Solution:

No. of trucks/day in each direction = $(400 \times 20 / 100) / 2 = 40$ (daily rate)

Projection factor for 20 years = 1.8 (from Table 2)

Total no. of trucks/day in each direction = $40 \times 1.8 = 72$ (projected yearly rate)

Sample calculation for actual repetition:

For 13 S actual no. of repetition = (No. of axles per 100 trucks \times 72/100) \times (365 \times 20)

= $8 \times 72/100 \times 365 \times 20 = 42048$ (see Axle Load Distribution Table)

Comments:1st trial

Assuming, pavement thickness, $t = 8$ inch

Total fatigue used = 5.09%; which implies that the assumed thickness is over-estimated.

Therefore, thickness need to be reduced.

2nd trial

Assuming, pavement thickness, $t = 6.5$ inch

Total fatigue used = 661.39%; which implies that the assumed thickness is under-estimated.

Therefore, thickness need to be increased.

3rd trial

Assuming, pavement thickness, $t = 7.5$ inch

Total fatigue used = 57.36%; which is acceptable.

Therefore, pavement designed thickness is 7.5 inch.

Calculation Summary Table

Trial pavement thickness, t (in)		Trial1, t = 8					Trial2, t = 6.5					Trial3, t = 7.5						
Axle Load	Axle Load x 1.2	Actual Repetition	Stress, S	Stress Ratio	Allowable Repetition	Percent fatigue used	Stress, S	Stress Ratio	Allowable Repetition	Percent fatigue used	Stress, S	Stress Ratio	Allowable Repetition	Percent fatigue used				
(kips)	(kips)	(see sample cal.)	(from Fig.1&2)	(S/M _R)	(from Table 1)		(from Fig.1&2)	(S/M _R)	(from Table 1)		(from Fig.1&2)	(S/M _R)	(from Table 1)					
13 S	15.6	42048	182.53	0.28	Unlimited	0.00	255.74	0.39	Unlimited	0.00	222.81	0.34	Unlimited	0.00				
15 S	18.0	38368.8	210.80	0.32	Unlimited	0.00	291.37	0.45	Unlimited	0.00	255.81	0.39	Unlimited	0.00				
17 S	20.4	32061.6	238.08	0.37	Unlimited	0.00	325.93	0.50	Unlimited	0.00	287.30	0.44	Unlimited	0.00				
19 S	22.8	28382.4	265.50	0.41	Unlimited	0.00	360.86	0.56	100000	47.30	318.45	0.49	Unlimited	0.00				
21 S	25.2	16819.2	291.03	0.45	Unlimited	0.00	393.57	0.61	24000	116.80	347.61	0.53	240000	7.01				
23 T	27.6	39945.6	200.45	0.31	Unlimited	0.00	274.31	0.42	Unlimited	0.00	236.44	0.36	Unlimited	0.00				
25 T	30.0	44150.4	217.16	0.33	Unlimited	0.00	292.87	0.45	Unlimited	0.00	256.35	0.39	Unlimited	0.00				
27 T	32.4	47304	233.60	0.36	Unlimited	0.00	311.35	0.48	Unlimited	0.00	275.75	0.42	Unlimited	0.00				
29 T	34.8	58867.2	248.43	0.38	Unlimited	0.00	328.21	0.50	Unlimited	0.00	293.56	0.45	Unlimited	0.00				
31 T	37.2	49406.4	262.93	0.40	Unlimited	0.00	344.86	0.53	240000	34.31	311.10	0.48	Unlimited	0.00				
33 T	39.6	9460.8	277.10	0.43	Unlimited	0.00	361.29	0.56	100000	15.77	328.38	0.51	400000	2.37				
35 T	42.0	7358.4	295.59	0.45	Unlimited	0.00	382.96	0.59	42000	29.20	348.27	0.54	180000	4.09				
37 T	44.4	4730.4	314.74	0.48	Unlimited	0.00	405.67	0.62	18000	43.80	368.38	0.57	75000	6.31				
39 T	46.8	5256	332.69	0.51	400000	2.19	427.22	0.66	6000	146.00	387.77	0.60	32000	16.43				
41 T	49.2	525.6	348.63	0.54	180000	0.49	446.56	0.69	2500	35.04	405.47	0.62	18000	2.92				
43 T	51.6	525.6	362.55	0.56	100000	0.88	463.60	0.71	1500	58.40	421.55	0.65	8000	6.57				
45 T	54.0	525.6	375.21	0.58	57000	1.54	479.23	0.74	650	134.77	435.68	0.67	4500	11.68				
Total fatigue used =						5.09	Total fatigue used =					661.39	Total fatigue used =					57.36

Table 1 Stress Ratios Allowable Load Repetitions^a

Stress Ratio ^b	Allowable Repetition	Stress Ratio ^b	Allowable Repetition
<=0.50	Unlimited	0.68	3500
0.51	400000	0.69	2500
0.52	300000	0.7	2000
0.53	240000	0.71	1500
0.54	180000	0.72	1100
0.55	130000	0.73	850
0.56	100000	0.74	650
0.57	75000	0.75	490
0.58	57000	0.76	360
0.59	42000	0.77	270
0.6	32000	0.78	210
0.61	24000	0.79	160
0.62	18000	0.8	120
0.63	14000	0.81	90
0.64	11000	0.82	70
0.65	8000	0.83	50
0.66	6000	0.84	40
0.67	4500	0.85	30

^a E.J. YODER and M.W. WTCZAK, "Principles of Pavement Design, 2nd Edition, Table 17.1, P.603

^b Load stress divided by modulus of rupture.

Table 2 Yearly Rates of Traffic Growth and Corresponding Projection Factors^a

Yearly Rate of Traffic Growth (percent)	Projection Factor for 20 years	Projection Factor for 40 years
1.0	1.2	1.2
1.5	1.3	1.3
2.0	1.5	1.5
2.5	1.6	1.7
3.0	1.8	1.9
3.5	2.0	2.2
4.0	2.2	2.5
4.5	2.4	2.8
5.0	2.7	3.2
5.5	2.9	3.6
6.0	3.2	4.1

^a E.J. YODER and M.W. WTCZAK, "Principles of Pavement Design, 2nd Edition, Table 17.1, P.607

Reinforcement Details of Rigid Pavement

Types of Reinforcement

- Temperature/distributed reinforcements
 - used to control the width of the crack opening and not to prohibit the formation of cracks
 - not to increase structural capability of the pavements
 - smaller in sizes
 - applied in the slab, usually in both directions in the form of welded wire-mesh or bar-mat
 - amount depend on length of panel & thickness of slab
- Dowel bars
 - used as a load transferring device (with high shearing strength i.e. with large x-sectional area)
 - used to reduce deflection of slab edge and to control pumping effect
 - 25mm (#8) or 32mm (#10) in size, 600mm (2') long and spaced @200mm (8") to 300mm (12") c/c
 - applied only in longitudinal direction and across the expansion & contraction joints
 - to allow freedom of movement of the slab, dowel bars must be smooth and lubricated
 - become necessary for longer span i.e. >12m or 40' (due to excessive movements of expansion joints)
 - they are placed at mid-depth of the slab
- Tie bars
 - are used to tie two adjacent slabs together
 - the bars are not so heavy and are smaller than dowel bars & spaced at greater intervals
 - usually 12mm (#4) - 19mm (#5) bars are used
 - length of tie bars are determined from bond criterion
 - must be deformed or hooked and must be firmly anchored into the concrete to function properly

Top View

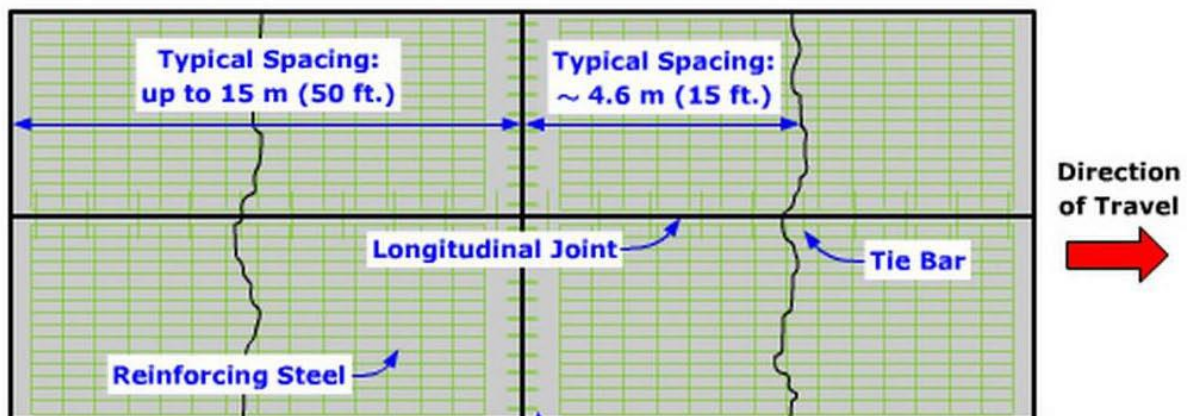

Side View

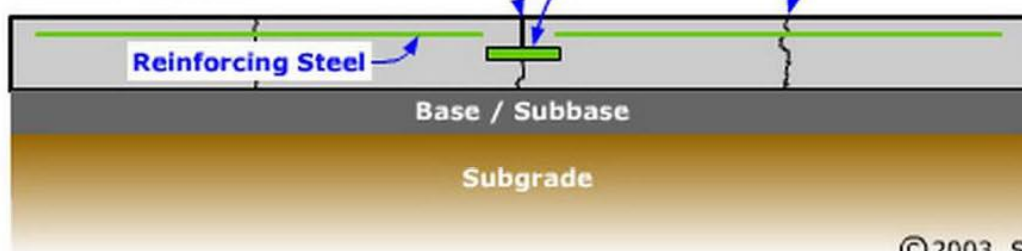

©2003 Steve Muench

Jointed Reinforced Concrete Pavement (JRCP)

Calculation of Temperature Reinforcement

- Assumption - resistance to movement of slab will be overcome by tension in steel
- $A_s = (Wf/f_s)L$
 Where A_s = steel per foot of width; W = weight of slab (lb/ft²)
 f = co-efficient of resistance (generally assumed to be 1.5); f_s = allowable stress of steel (psi)
 L = length of slab (in longitudinal direction L is $L/2$ & in transverse direction L is L w.r.t edge restraint condition)
- From the equation it is seen that the amount of steel is directly proportional to L , as such amount of steel can be reduced to zero by shortening the length of the slab
- On the contrary, shorter slab increases no of joints ; as joints are vulnerable and costly to maintain there need to make a trade-off between slab length (cost of reinforcement) and no of joints (cost of joint construction)

Example

Design reinforcement for the following:

Thickness of rigid pavt., t =	12 inch
No of lanes =	2
Width of pavement, w =	24 ft
Spacing of transverse joint =	45 ft (Contraction Joint @ 22.5ft)
Allowable strength of:	
Shrinkage steel(bar-mat) =	33000 psi
Tie bars =	27000 psi
Bond =	350 psi (10% of comp. strength of concrete)

Draw reinforcement and joint details.

Solution:

Amount of shrinkage reinf., A_s (in²/ft) = $(Wf/f_s) \times$ Effective length

$$\begin{aligned} \text{Wt. of pavt, } W &= 150 \times 12/12 = 150 \text{ lb/ft}^2 \\ \text{Coefficient of friction, } f &= 1.5 \end{aligned}$$

Distributed temperature reinforcement:

$$\begin{aligned} \text{Longitudinal direction, } A_s &= (150 \times 1.5/33000) \times 45/2 = 0.153 \text{ in}^2/\text{ft} \\ \text{If \#4 bars are used, spacing} &= \text{Area of bar}/A_s = 0.2/0.153 = 1.304 \text{ ft or } 1 \text{ ft c/c} \end{aligned}$$

$$\begin{aligned} \text{Transverse direction, } A_s &= (150 \times 1.5/33000) \times 24/2 = 0.082 \text{ in}^2/\text{ft} \\ \text{If \#4 bars are used, spacing} &= \text{Area of bar}/A_s = 0.2/0.082 = 2.444 \text{ ft or } 2 \text{ ft c/c} \end{aligned}$$

Tie bars along longitudinal construction joints:

$$\begin{aligned} \text{Longitudinal direction, } A_s &= (150 \times 1.5/27000) \times 24/2 = 0.100 \text{ in}^2/\text{ft} \\ \text{If \#5 bars are used, spacing} &= \text{Area of bar}/A_s = 0.31/0.1 = 3.1 \text{ ft or } 3 \text{ ft c/c} \\ \text{Length of tie bars is, } t \text{ (in)} &= 0.5(f_s d)/f_b + 3" = 0.5(27000 \times 5/8)/350 + 3 \\ \text{(where } d &= \text{dia of tie bar in inch)} &= 27.11 \text{ in or } 2 \text{ ft c/c} \end{aligned}$$

Dowel bars across Transverse & Contraction joints:

	Transverse Joints	Contraction Joints*
Bar size	10 no	8 no
Length	2 ft	2 ft
Spacing	8 in c/c	12 in c/c

*where part of load transferred by interlocking of aggregates

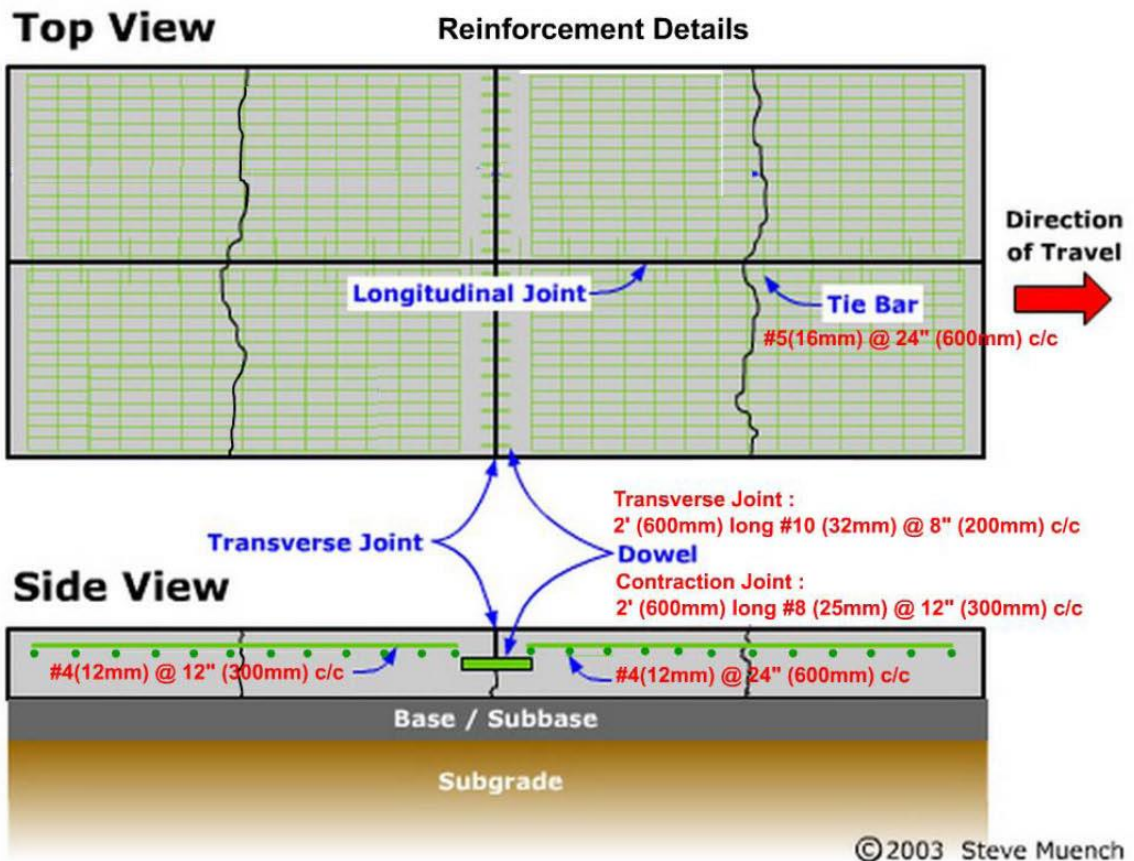

Jointed Reinforced Concrete Pavement (JRCP)

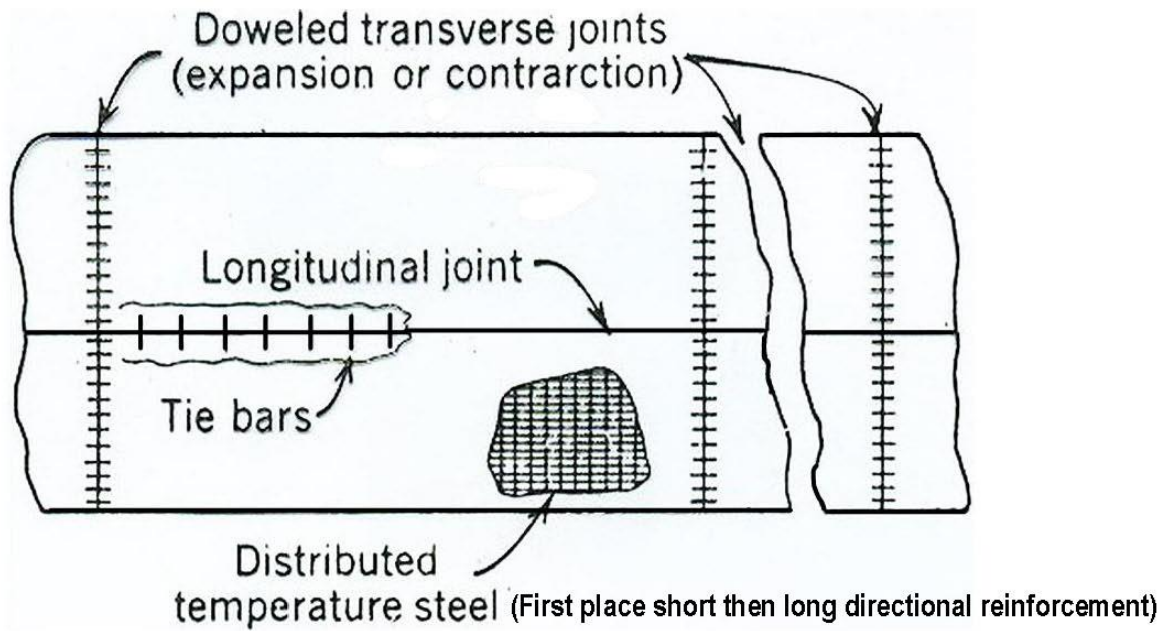



**Government of the People's Republic of Bangladesh
Ministry of Communications
Roads and Railways Division**

**Pavement Design Guide
for
Roads & Highways Department**

April 2005

Foreword

In order that all roads under the Roads and Highways Department are designed and built to appropriate high standards a series of RHD design guides and standards are being developed. This Pavement Design Guide, which has been prepared by RHD officers working in conjunction with the IDC3 Consultants, forms part of this series.

This Guide contains a straightforward procedure for the design of new flexible road pavements based on the cumulative number of Equivalent Standard Axles that the road will be subjected to during the required design life of the road. Standard pavement designs are included for both 3.7m and 5.5m roads whilst all other new road pavements, including the full reconstruction or widening of existing roads, should be designed in accordance with this Guide.

Where existing roads are to be partially reconstructed, or strengthened by means of an overlay, the requirement for these works will be included in the RHD Annual Roads Needs Assessment Report with typical details shown in the RHD Standard Drawings.

I wish to thank and commend all of the officers of the RHD involved in the preparation of this Guide which will go along way towards ensuring that consistent high quality road pavements are provided for an RHD roads in Bangladesh.

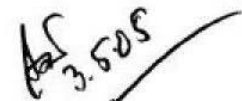

A.K.M. Faizur Rahman
CHIEF ENGINEER

Roads and Highways Department
Sarak Bhaban, Ramna, Dhaka.

April 2005

CONTENTS

	Page
1. INTRODUCTION	3
2. PAVEMENT DESIGN	4
2.1 Principles of Design	4
2.2 Design Procedure	4
3. DRAINAGE DESIGN	7
4. PARTIAL RECONSTRUCTION OF ROADS AND PAVEMENT STRENGTHENING	9
5. STRATEGIC ROADS	9
APPENDIX 1: Standard Pavement Designs	
APPENDIX 2: Example of Pavement Design	

Glossary of terms and abbreviations used

4WMV	4-Wheel Motorised Vehicle
AADT	Annual Average Daily Traffic
AASHTO	American Association of State Highway and Transportation Officials
BRRL	Bangladesh Road Research Laboratory
CBR	California Bearing Ratio
ESA	Equivalent Standard Axle
RHD	Roads and Highways Department
Standard Axle	8160 kg = 1800 lb = 18 kip
TRL	Transport Research Laboratory
UK	United Kingdom

1 Introduction

The design of flexible road pavements is generally thought to be a specialist activity that can only be undertaken by consultants experienced in this type of design. Part of the reason for this may be that foreign consultants engaged on the design of road pavements in Bangladesh have tended to use design standards from their respective countries, or other international standards with which they are familiar.

This RHD Pavement Design Guide has been prepared based on two internationally recognized design standards, namely the AASHTO Pavement Design Manual and the TRL Overseas Road Note 31, with a view to making the design of road pavements as straightforward as possible and to ensure that the same standards are adopted for all RHD roads.

For roads that are intended to carry only low volumes of traffic standard pavement designs have been included, together with an easy to follow design procedure to identify the required thickness of the various pavement layers for other more heavily trafficked roads. In this respect, throughout this Guide the following descriptions have been adopted for these pavement layers:

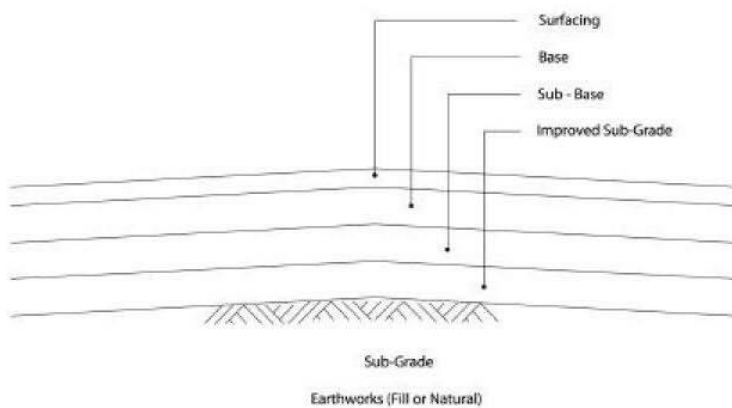

Surfacing is the riding surface of the road and varies from a light bitumen spray with stone chippings (bitumen surface treatment) to one or more layers of dense bitumen surfacing.

Base is the main load-spreading layer of the road pavement. It must be constructed of high quality brick or stone aggregate.

Sub-base is the secondary load-spreading layer of the pavement. It is usually either crushed stone, broken brick aggregate (frequently mixed with sand) or locally available gravel.

Improved Sub-grade is imported material (e.g. fine or coarse sand) that is locally available. It is intended to act as a cushioning layer between weak sub-grades and the road pavement layers. If the sub-grade is of sufficient strength (i.e. CBR value) then an improved sub-grade may not be required.

Sub-grade is the soil immediately beneath the road structure. It is a layer of natural locally available material that meets the requirements of RHD Technical Specifications.

2 Pavement Design

2.1 Principles of Design

Natural ground, including earth embankments, cannot support the wheel loads of vehicles - particularly when wet. The purpose of a road pavement is to distribute and spread wheel loads through to the underlying ground (i.e. the sub-grade) via pavement layers of the required thickness and strength such that each layer can support the load transmitted from the layer immediately above it without deformation.

The strength of each layer is expressed in terms of the California Bearing Ratio (CBR) and it is essential that the materials used, and compaction obtained, for each layer achieves the required CBR for that layer. If the underlying layers do not have the required CBR then the upper layers of a road pavement will fail even if they have been correctly constructed.

The CBR requirements for the various pavement layers are contained in the RHD Specification and are summarized as follows:

Pavement Layer		CBR	RHD Specification Clause
Aggregate Base	Type I	$\geq 80\%$	3.3.2
	Type II	$\geq 50\%$	3.3.2
Sub-base		$\geq 25\%$	3.2.2
Improved Sub-grade		$\geq 8\%$	2.8.2
Sub-grade		$\geq 5\%$	2.7.2
Embankment fill/natural ground		$\geq 3\%$	2.6.2

Table 1: Required CBR for Pavement Layers

Reference should be made to the RHD specification for the materials, workmanship and testing procedures that should be adopted to achieve the above CBR values.

Standard pavement designs for 3.7m and 5.5m roads are shown at Appendix 1. All other road pavements require to be designed with the thickness of the various pavement layers, including the bituminous surfacing, being determined by estimating the cumulative number of Equivalent Standard Axles (ESAs) that the road will be subjected to over its design life, and then reading off the required thickness for each layer from the design chart included at Table 5. An example of a pavement design based on this method is included at Appendix 2.

2.2 Design Procedure

Base Year Traffic Counts

For both the geometric and pavement design of new roads, or the upgrading / widening of existing roads, traffic counts must be undertaken to establish the current Average Annual Daily Traffic (AADT) on the road. At least one whole day (24 hour) traffic count in both

directions of flow should be undertaken on a typical weekday for sections of the road having more or less the same traffic volumes.

For geometric design purposes the forecast traffic demand for the road in the design year should be estimated expressed in passenger car units (PCUs). This determines the required capacity or width of the road and details of this design procedure are contained in the RHD Geometric Design Manual.

For the design of road pavements a different approach is adopted in that an estimate must be made of the cumulative number of heavy axle loads that the road pavement will be subjected to over its design life. In this cars, rickshaws and other light traffic may be ignored with only trucks and other commercial vehicles being considered.

For single carriageway roads the average truck and commercial vehicle flow in both directions is adopted for design purposes i.e. 0.5 x the sum of both directions. For dual carriageways, where trucks may be more heavily loaded in one direction than the other, the pavement for each carriageway should be subject to a separate design based on the forecast commercial traffic for that carriageway (heaviest loaded lane).

Design Life and Traffic Growth Rates

For new roads and the full depth reconstruction of existing roads the following design standards are to be adopted:

	Pavement Design Life	Traffic Growth Rate
National Road	20 years	10% pa
Regional Road	20 years	7% pa

Table 2: Pavement Design Life and Traffic Growth Rates

Where a new or reconstructed road is likely to lead to a significant generation or diversion of traffic, detailed traffic studies should be undertaken to estimate the additional traffic that will use the road in addition to the estimated base flow.

Determining Cumulative ESAs Over the Pavement Design Life

For pavement design purposes all heavy commercial vehicles are expressed in terms of the equivalent number of standard axles that they represent. A Standard Axle is taken to be 8,160 kg. Based on axle load studies previously undertaken in Bangladesh, the following equivalence factors have been determined:

Vehicle Category	Equivalence Factor
Large Truck (dual axle)	4.8
Medium Truck (Single axle)	4.62
Small Truck	1.0
Large Bus	1.0
Mini Bus	0.5

Table 3: Vehicle Equivalence Factors

Using the recorded (or estimated) AADT for the above vehicle categories together with their equivalence factors, estimates should be made of the current daily ESAs for the road. This should then be multiplied by 365 to obtain the annual ESAs for the road.

To obtain the cumulative ESA loading over the design life of the road, the current annual ESA loading should be multiplied by one of the following factors:

Road Type	Factor
National Road	57.3
Regional Road	41.0

Table 4: Cumulative Growth Factors

The above factors have been derived from the following compound growth formula:

$$\text{Cumulative ESA} = \frac{(1 + r)^n - 1}{r} \quad \text{where } r = \text{annual traffic growth rate}$$

$$n = \text{design life in years}$$

(Note: For National Roads $r = 10\%$ and $n = 20$ years; For Regional Roads $r = 7\%$ and $n = 20$ years)

Determination of Pavement Layers

The estimated cumulative ESAs are then used to determine the various pavement layers from the following design chart:

mm Traffic ESA (mill)	Surfacing (mm)		Roadbases (mm)* (Select one type)			Sub-bases (mm)** Subgrade CBR %			
	Asphalt Wearing Course	Asphalt Base- Course	Cement- bound Granular	Granular Base Type I	Granular Base Type II	5	8 - 25	> 25	
60 - 80	↓	155	↓ Refer to BRRRL for design advice	N/A	N/A	300	150	0	
40 - 60		140							
30 - 40		125							
25 - 30		110							
17 - 25		105							
15 - 17		95							
11 - 15		90							
9 - 11		80							
7 - 9		70							
6 - 7		65							
5 - 6		60							
4 - 5		55							
3 - 4	45								
< 3	35								

* CBR of granular base type I is min. 80% N/A. = not applicable
 * CBR of granular base type II is min. 50%
 ** CBR of sub-base material is 25%

Table 5: Thickness Design Table for Flexible Pavements

Determination of Improved Sub-grade Thickness

It can be seen from the foregoing design chart that it assumes a minimum sub-grade strength of 5% CBR. In Bangladesh, apart from higher ground within the Chittagong Hill Tracts where in situ CBRs will be higher, most roads are constructed on embankments that will have a CBR of less than 5%. Under these circumstances an improved sub-grade layer should be provided as follows:

CBR Required	Compacted Thickness of additional layer to provide required CBR			
	CBR of Underlying layer			
	2%	3%	4%	5%
5%	450 mm	300 mm	250 mm	200 mm

Table 6: Improved Sub-grade Requirements

In all cases, sub-grade material with a CBR of less than 2% should be removed and replaced with fill material complying with Section 2.6 of the RHD Specification

3. Drainage Design

Freeboard

Much of Bangladesh is subject to flooding on an annual basis, and occasionally this flooding is of a severity that results in parts of the road network being inundated. Understandably traffic, and in particular heavy commercial vehicles, continue to use these roads and this can result in severe damage being done to the road pavement.

Accordingly, in the design of new roads or full reconstruction of existing roads the freeboard to the lowest edge of the pavement surface, above Highest Flood Level (HFL) (50 year return period for National and Regional Highways and 20 year return period for District (Zila) Roads), shall be at least the values shown in the table below, and in any event the Formation Level (top of sub-grade level) should be at least 30 cm above HFL.

Road Type	Freeboard (m)
Dual 1 carriageway	1.0
7.3 m carriageway	1.0
6.2 m carriageway	1.0
5.5 m carriageway	0.9
3.7 m carriageway	0.9

Table 7: Freeboard

In view of the foregoing all RHD Divisions should determine the HFL for the 50 and 20 year return period within their Division, and record this by means of permanent marks on an outer wall of the Divisional offices or other Government building within the Division.

Sub-grade Drainage

To prevent rapid deterioration of the pavement layers and to maintain the sub-grade at or above the design strength it is essential to allow all water entering the pavement layers to drain away as quickly as possible. [Standing water in the pavement layers will cause a reduction in strength and result in high pore-water pressures under traffic loading that will lead to surface disintegration.]

Where full depth pavement construction is being undertaken incorporating an improved sub-grade (i.e. a sand layer) this should be extended for the full width of the embankment such that it can act as a drainage layer.

Where only partial reconstruction is being undertaken, or only the provision of hard shoulders, sub-grade drains should be provided between the existing road pavement and the edge of the embankment as detailed in the RHD Standard Drawings.

Surface Water Drainage

The road surface should be designed to shed water as quickly as possible during rain. Standing water is both a serious traffic hazard and will eventually soak through the pavement layers, weakening its structure. Key design considerations are as follows:

- A good surface drainage requires an impermeable surface. This will be achieved through meeting the RHD Specification for surfacing materials and through carrying out sufficient planned maintenance.
- The surface must be laid to the correct camber and falls and low spots should be avoided.
- Unpaved shoulders should generally have a steeper camber than the road pavement (e.g. 5%) with a small step (e.g. 25-38 mm) between pavement and shoulder.
- Rural roads in cuttings should include a side ditch a minimum of 1m deep with culverts provided through access roads to ensure the ditch is continuous.

Where existing roads pass through villages or bazaars it is frequently the case that they require full or partial reconstruction. Almost invariably the deterioration of these roads is a direct result of inadequate surface water drainage, either because such drainage was not provided in the first place or because the drainage facilities that are there are blocked due to lack of maintenance.

In any event where roads pass through villages, bazaars and other locations where there is frontage development they should be provided with positive surface water drainage with a longitudinal gradient of not less than 0.3% to an outfall. This drainage must be maintained and regularly cleaned as part of the routine maintenance of the road.

Cross Drainage

Where embankments are, or have been, constructed they may obstruct the natural passage of water at ground level. In effect this means that the embankment can act as a dam and cause localized flooding.

To prevent this, in addition to the provision of bridges and culverts where embankments cross existing water courses, cross drainage structures in the form of 1m diameter pipe culverts should be provided at regular intervals. Typical details for pipe culverts are contained in the RHD Standard Drawings.

4. Partial Reconstruction of Roads and Pavement Strengthening

Partial Reconstruction

Where existing roads require partial reconstruction these will have been identified in the RHD Annual Roads Needs Assessment Report. The type of partial reconstruction that is required will differ for Zilla roads and National / Regional roads, and for the latter whether they are high or low volume traffic routes.

Typical details for the various types of partial reconstruction are contained in the RHD Standard Drawings and these should be adopted wherever partial reconstruction is to be undertaken.

Pavement Strengthening

An existing road pavement that is in otherwise good condition may require strengthening to extend or maintain its design life. Frequently this takes the form of a bituminous overlay, the thickness of which being a function of the forecast ESA loading and the condition of the existing road.

Here again the strengthening requirements will be identified in the RHD Annual Roads Needs Assessment Report and no design by the Divisions will be required.

5. Strategic Roads

These design standards are a simplified version of the international standards upon which they are based. As such they will be appropriate for the design of road pavements for the majority of the roads in Bangladesh.

However, for strategic roads in the National Road network that will be subjected to very high traffic flows these Standards may only be used as a guide to the pavement design. In all such cases these roads must be designed in accordance with the AASHTO Design Manual or Overseas Road Note 31 as appropriate.

Appendix 1: Standard Pavement Designs

Type 5: 5.5m Carriageway

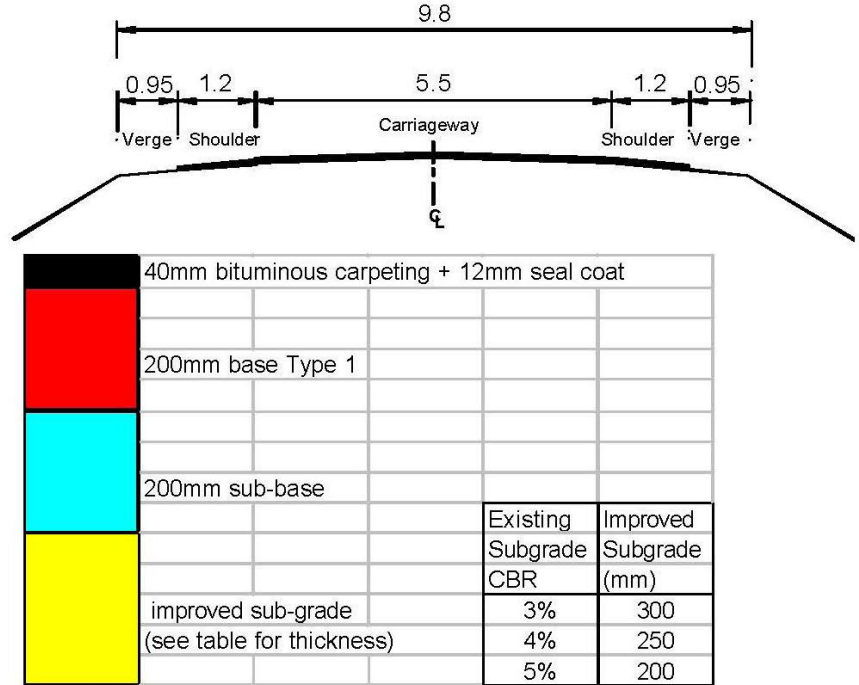

Type 6: 3.7m Carriageway

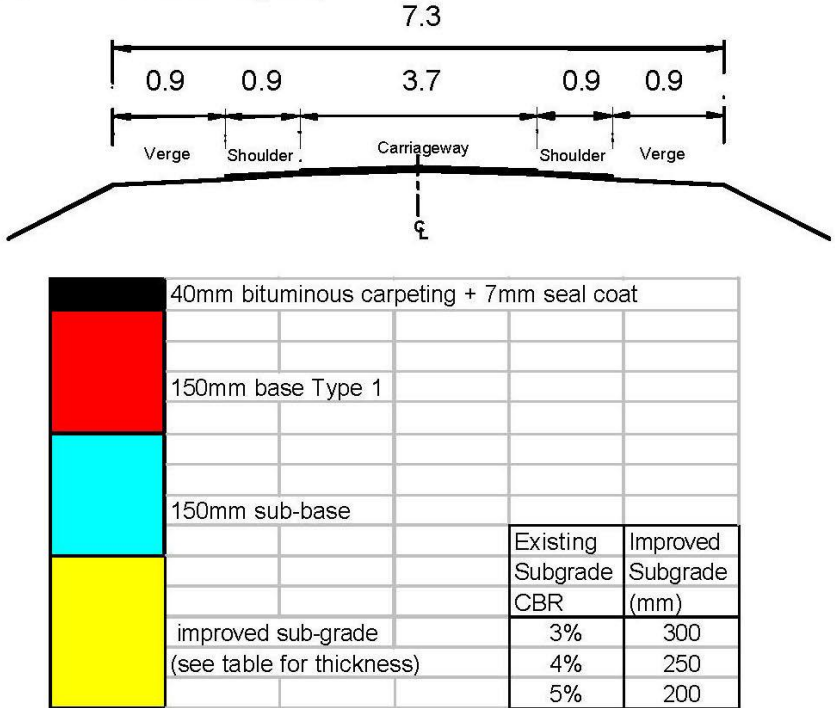

10/10/05

Appendix 2: Example of Pavement Design

Background: An existing 6.2m Regional Road that is located on an embankment requires full reconstruction. A check has been made and the existing road surface is 1.0m above the Highest Flood Level for a 50 year return period. Accordingly the embankment does not require to be raised.

A number of trial pits were undertaken and the CBR of the sub-grade beneath the existing road was found to be 3%.

A 24 hour classified traffic count was carried out on a typical weekday.

Design:

Half of the two-way flow of commercial vehicles is used to determine the cumulative ESAs over the design life of the road as follows:

	Existing Flow / day (0.5x two-way flow) (a)	ESA Factor (b)	Existing ESAs / day (a) x (b)	Annual ESAs (a) x (b) x 365
Heavy truck	20	4.8	96	35,040
Medium truck	150	4.62	693	252,945
Light truck	50	1.00	50	18,250
Large bus	100	1.00	100	36,500
			Total	342,735

By reference to Table 4 and using the appropriate factor for a Regional road the cumulative ESAs over the design life for the road will be:

$$342,735 \times 41.0 = 14 \text{ million ESAs}$$

By reference to Table 6 an improved sub-grade will be required to achieve a sub-grade strength of 5% CBR and by reference to the design chart in Table 5 the required pavement layers will be:

- 130 mm DBS (40mm wearing course + 90mm base course)
- 250 mm Base Type 1
- 200 mm Sub-Base
- 300 mm Improved sub-grade

Catalogue of Pavement Structures

A. Problems associated with Road Infrastructures Development in Bangladesh

- Cost of highway construction is very high due to**
 - 75% area is at or near flood level - need high embankment or wide r.o.w.
 - Comprises unconsolidated alluvial deposit i.e. poor foundation condition- need subgrade stabilization, wide embankment or r.o.w . Moreover, due to agricultural based economy huge amount of land surface are made uncovered and loosen which causes perennial erosion problems.
 - Riverine topography – need high density of suspended structures.
 - Scarcity of high quality construction materials (natural aggregates, bitumen etc.)
- Highway maintenance is also very expensive due to**
 - Recurrent** flood caused by
 - Heavy rainfall
 - Siltation problem - Rivers carry **huge amount of sediments** generated from upstream, surface erosion and river bank erosion along with **low gradient of land** surface (Total RL change in NS is only 25m over 530km i.e. 0.005% gradient) - reduces speed of river stream and help to deposit sediments in large scale
 - Prolonged** flood/submergence due to construction of high embankments in the E-W direction without adequate drainage facilities which prevents natural flow of runoff
- Other Problems**
- Overloading
- Short construction periods
- Lack of funds for timely maintenance of infrastructures

B. Catalogue of Pavement Structures

Considering the above issues, economical design of roads infrastructures is utmost important for our country. Moreover, ditto copy of western methods of pavement design viz. AASHTO, The Asphalt Institute, Road Note 31 are not for our local conditions as these methods are developed in different climatic conditions and based on different construction practices. Calibration or estimation of different input parameters, especially layer (SN) and drainage coefficient of these western methods, are very difficult to perform. As such pavement design by using these established methods may lead to unreliable as well as uneconomical design. As such we have to have our own method of road design.

Considering the behavior of local materials, climatic conditions and construction practices, **a Catalogue of Pavement Structures** is developed

- to simplify design procedure
- to prevent both under-design and over-design and thereby
- to ensure economical design

Catalogue of Pavement Structures

Applicable for

- Undivided rural road having crest width ranging from 5.6 - 7.3m
- Flexible and semi-rigid pavement (i.e. ratio of modulus between two successive layer is < 5)
- Cumulative traffic 0.5 - 30 MESA (Million Equivalent Standard Axles)

Based on

- Empirical analysis - investigating behavior of existing pavement structure and experience gathered in other countries with similar conditions
- Experimental results- laboratory tests of local soil and road construction materials
- Theoretical knowledge - consideration of pavement mechanism i.e. elastic theory of pavement behavior under the effect of traffic
- Finally design catalogue is prepared by checking PADMA (Pavement Design By Mechanistic Analysis) software (stress and strain are calculated at the interface of the layers & compared with admissible values as function of expected maximum axle load, cumulative traffic, material characteristics)
- Structures proposed are intended to use materials & construction technique traditionally pertaining in Bangladesh
- A balancing between geometric and structural design of pavement

Problem 1

Design flexible pavement for an undivided rural highway by using Catalogue of Pavement Structures Method for the following data.

Given:

The forecast AADT for 2003 the year of opening, is assessed as:

Vehicles Types	Two-way AADT vpd
Large Truck	104
Small Truck	115
Large Bus	500
Small Bus	50
Car	300
Autorickshaw	100
Motor Cycle	150
Bicycle	100
Rickshaw	500
Cart	10

Assume:

Growth rate, r =	8 % per annum
Design period, n =	15 year
CBR of Subgrade =	12 %

Solution:**A) Determination of Roadway Geometry:**

Vehicles Types	Traffic Volume at 2003	PCU Factors	PCU/day at 2003
Large Truck	104	3.00	312
Small Truck	115	2.00	230
Large Bus	500	2.50	1250
Small Bus	50	1.50	75
Car	300	1.00	300
Autorickshaw	100	0.50	50
Motor Cycle	150	0.30	45
Bicycle	100	0.25	25
Rickshaw	500	2.00	1000
Cart	10	4.00	40

Total = **3327**

Forecasted design flow in 2018 = $3327 \times (1.08)^{15} = 10554$ PCU/day

From the Manual of Geometric Design Standards the recommended:

Road class =	Regional Category
Road width =	6.2 m
Shoulder width =	1.2 m

B) Determination of Cumulative ESAL for Pavement Design:

Considering damaging effect, only heavy vehicles are taken into account:

Heavy Vehicles Types	Two-way AADT vpd	ESAL Per veh.	Cumulative ESAL*
Large Truck	104	4.8	4,947,332
Small Truck	115	1	1,139,710
Large Bus	500	1	4,955,261
Small Bus	50	0.5	247,763

* Cumulative ESAL = $365 \times \text{AADT} \times \text{ESAL} \times [(1 + r)^n - 1]/r$

Total Cumulative ESAL in both direction =	11,290,066	
Total Cumulative ESAL in one direction =	5,645,033	(DD= 50%)

Determination of the Channelisation Factor

The proportion of non-motrised traffic to heavy vehicles is:

$$P = (100 + 500 + 10)/(104 + 115 + 500 + 50) = 0.79$$

By interpolation Channelisation Factor from Table 3 = 1.9

$$\text{Thus Design Cumulative Traffic} = 5645033 * 1.9 = 10,725,563 \text{ ESA}$$

$$= 10.7 \text{ MSA}$$

C) Determination of Pavement Layer Thickness:

From Table 4, Traffic Class =	T4	for 10.7 MSA
From Table 5, Subgrade Class =	S4	for 12 % CBR

Using Charts of Catalogue propose alternative designs of pavement with varying material types. Then evaluate alternatives based on availability of materials, construction strategy and economy.

Table 1: PCU Factors for Rural Road

Vehicle Types	PCU Factors
Large Truck	3.0
Small Truck	2.0
Large Bus	2.5
Small Bus	1.5
Car/Tempo	1.0
Autorickshaw	0.5
Motor Cycle	0.3
Bicycle	0.3
Rickshaw	2.0
Cart	4.0

Table 2: ESAL per Vehicle

Vehicle Types	ESAL Per veh
Large Truck (10-Wheeler)	4.80
Medium Truck (6-Wheeler)	4.62
Small Truck (4-Wheeler)	1.00
Large Bus	1.00
Small Bus	0.50

Table 3: Channelisation Factor

Road Width		Channelisation Factor depending on the ratio of NMV to be applied to 1-way flow	
m	ft	Low(<0.5)	High (>=0.5)
5.6	18.4	2.0	2.0
6.8	22.3	1.0	1.8
7.3	23.9	1.0	1.6

Table 4: Traffic Definition

Class	MSA
T0	<0.5
T1	0.5 - 1.5
T2	1.5 - 3.0
T3	3.0 - 7.5
T4	7.5 - 20.0
T5	20 - 30

Table 5: Subgrade Definition

Class	CBR
S1	3 - 5
S2	5 - 7
S3	7 - 10
S4	10 - 15
S5	>15

National Roads-Cross-Section Design Capacities

Cross-Section	Optimum Design Capacity (PCU/Hour)	Maximum Capacity (PCU/Hour)	Design Year Demand Flow (PCU/Hours)	Optimum Flow Range (3)	Application	
					New Construction	Widening w.r.t. RHD (2)
RHD 6.7m	1000 (Daily = 14,000) (Note 3)		1 to 1000		Not applicable. New 7.4m standard always has a better overall economic performance.	No widening necessary if demand flows less than 1000 PCU/hours
4.7m + Pre-widening of embankment to 11 m standard	1900 (Daily = 27,000)		1 to 1900 (New Construction) 1001 to 1900 (Widening)		The standard new minimum width for National road with the high mobility function	If traffic demand is above 1000 PCU/Hours widening justified and can be easily carried out by re-arranging the road layout on the existing embankment crest width.
11m + Pre-widening of embankment to 4 x 3.7m standard	(2200)		(1900 - 2200) But, optimal flow range too narrow to be usefull.		Not applicable as a final design standard but usefull as part of stage construction on way to the high level 4 x 3.7m section.	Not applicable due to narrow optimal flow range and due to practical difficulties of widening from 6.7m to 11.0m under trafficking.
4 x 3.7m + Pre-widening of embankment to 6 x 3.67m standard.	4500 (Daily = 64,000)		1901 to 4500		A very useful width for high volume roads at a future date.	An economical widening choice for the basier National roads in Bangladesh.
6 x 3.67m	7500 (Daily = 105,000)		4501 to 7500		New roads needing this capacity very unlikely to develop.	Will undoubtedly have its application on the busiest roads, or in future second round widening.

















- Notes : 1) Real flow Peak Hour Factor of 0.07 taken.
 2) It is assumed that all widening takes place from a 6.7m RHD base.
 3) This design year flow range was demonstrated by the analysis to be optimal even if traffic growth on a particular project is forecast to be other than 8%, & anywhere between 5.6% & 9.2%, (the sensitivity analysis outer margings).

Regional Roads-Cross-Section Design Capacities

Cross-Section	Optimum Design Capacity (PCU/Hour)	Maximum Capacity (PCU/Hour)	Design year Demand Flow (PCU/Hour)	Optimum Flow Range (3)	Application	
					New Construction	Widening w.r.t RHD
RHD 5.5 m	750 (Daily 8300) (Note 1)		1 to 750		Not applicable. New 6.2m standard already has a better overall economic performance	No widen necessary of demand flows less than 750 PCU/Hour
6.2 m + Pre-widening of embankment to 7.4m standard	1700 (Daily = 18,500)		1 to 1700 (New Const.) 751 to 1700 (Widening)		The standard new minimum width for Regional roads	If traffic demand above 750 PCU/Hour widening can be easily carried out by re-arranging the road layout on the existing embankment width
7.4m + pre-widening of embankment to 11m standard.	(1900)		(1700-1900) But, optimal flow range too narrow to be useful		Not applicable as a find design standard but usefull part of stage construction on way to the top cross-section of 11 m.	Not applicable due to various optimal flow range and due to practical difficulties of widening 5.5m to 7km under traffic.
11m	2500 (Daily = 28,000)		1701-2500		Not likely that many completely new roads would need to adopt this standard at the out set.	An economical widening choice for the busier Regional roads in Bangladesh.

PAVEMENT CATALOGUE

MATERIAL DEFINITION

	ST SURFACE TREATMENT
	ASPHALT CONCRETE
	GRAVEL ASPHALT
	SAND BITUMEN
	HAND CRUSHED BRICKS WITH 0 - 20% LOCAL SAND
	WELL GRADED PLANT CRUSHED BRICKS (0/37mm)
	HAND/ PLANT CRUSHED BRICKS WITH 50% LOCAL SAND
	MIXTURE OF CRUSHED BOULDER, SHINGLES, PEA- GRAVELS & SAND (30: 30: 20: 20)
	MIXTURE OF COARSE SAND & LOCAL SAND (40: 60)
	HAND CRUSHED BOULDERS, PEA- GRAVELS & SAND (60: 20: 20)
	WELL GRADED PLANT CRUSHED BOULDERS (0/37mm)
	HAND/ PLANT CRUSHED BOULDERS WITH 50% LOCAL SAND
	WELL GRADED PLANT CRUSHED BRICK/ BOULDERS (0/37mm)
	HAND CRUSHED BRICKS WITH 0 - 20% LOCAL SAND OR MIXTURE OF CRUSHED BOULDER, SHINGLES, PEA- GRAVELS & SAND (30: 30: 20: 20)
	SOIL STABILISED WITH 4% LIME
	LOCAL FINE RIVER SAND / MECHANICALLY STAB. SAND CLAY MIXTURE / SANDY SILT WITH PI 5 - 8

TRAFFIC DEFINITION

T_1	=	MAX. 1.5 MILLION ESA
T_2	=	MAX. 3.0 MILLION ESA
T_3	=	MAX. 7.5 MILLION ESA
T_4	=	MAX. 20.0 MILLION ESA
T_5	=	MAX. 30.0 MILLION ESA

























SUBGRADE DEFINITION

S_1	=	MIN 3% CBR
S_2	=	MIN 5% CBR
S_3	=	MIN 7% CBR
S_4	=	MIN 10% CBR
S_5	=	MIN 15% CBR











CATALOGUE FOR PAVEMENT TYPE - 1 (BRICKS)

	S1	S2	S3	S4	S5
T1					
T2					
T3					
T4					
T5					











CATALOGUE FOR PAVEMENT TYPE - 2 (GRAVELS & STONE)

	S1	S2	S3	S4	S5
T1	 <div style="display: flex; flex-direction: column; justify-content: space-around; width: 100px;"> ST 150 250 225 </div>	 <div style="display: flex; flex-direction: column; justify-content: space-around; width: 100px;"> ST 150 250 175 </div>	 <div style="display: flex; flex-direction: column; justify-content: space-around; width: 100px;"> ST 150 250 150 </div>	 <div style="display: flex; flex-direction: column; justify-content: space-around; width: 100px;"> ST 150 250 100 </div>	 <div style="display: flex; flex-direction: column; justify-content: space-around; width: 100px;"> ST 150 250 </div>
T2	 <div style="display: flex; flex-direction: column; justify-content: space-around; width: 100px;"> ST 150 300 250 </div>	 <div style="display: flex; flex-direction: column; justify-content: space-around; width: 100px;"> ST 150 300 200 </div>	 <div style="display: flex; flex-direction: column; justify-content: space-around; width: 100px;"> ST 150 300 150 </div>	 <div style="display: flex; flex-direction: column; justify-content: space-around; width: 100px;"> ST 150 300 100 </div>	 <div style="display: flex; flex-direction: column; justify-content: space-around; width: 100px;"> ST 150 300 </div>
T3	 <div style="display: flex; flex-direction: column; justify-content: space-around; width: 100px;"> ST 200 225 250 </div>	 <div style="display: flex; flex-direction: column; justify-content: space-around; width: 100px;"> ST 200 225 175 </div>	 <div style="display: flex; flex-direction: column; justify-content: space-around; width: 100px;"> ST 200 225 125 </div>	 <div style="display: flex; flex-direction: column; justify-content: space-around; width: 100px;"> ST 200 225 100 </div>	 <div style="display: flex; flex-direction: column; justify-content: space-around; width: 100px;"> ST 200 225 </div>
T4	 <div style="display: flex; flex-direction: column; justify-content: space-around; width: 100px;"> 60 175 250 250 </div>	 <div style="display: flex; flex-direction: column; justify-content: space-around; width: 100px;"> 60 175 200 250 </div>	 <div style="display: flex; flex-direction: column; justify-content: space-around; width: 100px;"> 60 175 200 225 </div>	 <div style="display: flex; flex-direction: column; justify-content: space-around; width: 100px;"> 60 175 275 100 </div>	 <div style="display: flex; flex-direction: column; justify-content: space-around; width: 100px;"> 60 175 275 </div>
T5	 <div style="display: flex; flex-direction: column; justify-content: space-around; width: 100px;"> 60 200 250 250 </div>	 <div style="display: flex; flex-direction: column; justify-content: space-around; width: 100px;"> 60 200 200 250 </div>	 <div style="display: flex; flex-direction: column; justify-content: space-around; width: 100px;"> 60 200 200 225 </div>	 <div style="display: flex; flex-direction: column; justify-content: space-around; width: 100px;"> 60 200 250 125 </div>	 <div style="display: flex; flex-direction: column; justify-content: space-around; width: 100px;"> 60 200 250 </div>















CATALOGUE FOR PAVEMENT TYPE - 3
(GRAVEL ASPHALT BASE)

	S1	S2	S3	S4	S5
T1					
T2					
T3					
T4	 40 120 175 250	 40 120 150 250	 40 120 150 200	 40 120 175 100	 40 120 175
T5	 50 120 200 250	 50 120 175 250	 50 120 150 250	 50 120 200 100	 50 120 200











CATALOGUE FOR PAVEMENT TYPE - 4
(SAND BITUMEN BASE)

	S1	S2	S3	S4	S5
T1					
T2					
T3					
T4	 50 115 200 250	 50 115 175 250	 50 115 150 250	 50 115 200 100	 50 115 200
T5	 50 120 225 250	 50 120 200 250	 50 120 175 250	 50 120 225 100	 50 120 225





CATALOGUE FOR PAVEMENT TYPE - 5 (LIME STABILISED SUB-BASE)

	S1	S2	S3	S4	S5
T1	 <div style="display: flex; flex-direction: column; align-items: flex-end; margin-left: 10px;"> <div>ST</div> <div>150</div> <div>275</div> <div>200</div> </div>	 <div style="display: flex; flex-direction: column; align-items: flex-end; margin-left: 10px;"> <div>ST</div> <div>150</div> <div>250</div> <div>175</div> </div>	 <div style="display: flex; flex-direction: column; align-items: flex-end; margin-left: 10px;"> <div>ST</div> <div>150</div> <div>250</div> <div>125</div> </div>	 <div style="display: flex; flex-direction: column; align-items: flex-end; margin-left: 10px;"> <div>ST</div> <div>150</div> <div>325</div> </div>	 <div style="display: flex; flex-direction: column; align-items: flex-end; margin-left: 10px;"> <div>ST</div> <div>150</div> <div>250</div> </div>
T2	 <div style="display: flex; flex-direction: column; align-items: flex-end; margin-left: 10px;"> <div>ST</div> <div>150</div> <div>300</div> <div>225</div> </div>	 <div style="display: flex; flex-direction: column; align-items: flex-end; margin-left: 10px;"> <div>ST</div> <div>150</div> <div>300</div> <div>175</div> </div>	 <div style="display: flex; flex-direction: column; align-items: flex-end; margin-left: 10px;"> <div>ST</div> <div>150</div> <div>300</div> <div>125</div> </div>	 <div style="display: flex; flex-direction: column; align-items: flex-end; margin-left: 10px;"> <div>ST</div> <div>150</div> <div>375</div> </div>	 <div style="display: flex; flex-direction: column; align-items: flex-end; margin-left: 10px;"> <div>ST</div> <div>150</div> <div>300</div> </div>
T3	 <div style="display: flex; flex-direction: column; align-items: flex-end; margin-left: 10px;"> <div>ST</div> <div>200</div> <div>300</div> <div>175</div> </div>	 <div style="display: flex; flex-direction: column; align-items: flex-end; margin-left: 10px;"> <div>ST</div> <div>200</div> <div>275</div> <div>175</div> </div>	 <div style="display: flex; flex-direction: column; align-items: flex-end; margin-left: 10px;"> <div>ST</div> <div>200</div> <div>250</div> <div>150</div> </div>	 <div style="display: flex; flex-direction: column; align-items: flex-end; margin-left: 10px;"> <div>ST</div> <div>200</div> <div>325</div> </div>	 <div style="display: flex; flex-direction: column; align-items: flex-end; margin-left: 10px;"> <div>ST</div> <div>200</div> <div>250</div> </div>
T4					
T5					

CATALOGUE FOR PAVEMENT TYPE-6 (TO: ESA ≤ 0.5 MILLIONS)

	S1	S2	S3	S4	S5
ALT-1	 <div style="display: flex; flex-direction: column; align-items: center;"> <div style="margin-bottom: 5px;">ST</div> <div style="margin-bottom: 5px;">150</div> <div style="margin-bottom: 5px;">175</div> <div style="margin-bottom: 5px;">200</div> </div>	 <div style="display: flex; flex-direction: column; align-items: center;"> <div style="margin-bottom: 5px;">ST</div> <div style="margin-bottom: 5px;">150</div> <div style="margin-bottom: 5px;">175</div> <div style="margin-bottom: 5px;">150</div> </div>	 <div style="display: flex; flex-direction: column; align-items: center;"> <div style="margin-bottom: 5px;">ST</div> <div style="margin-bottom: 5px;">150</div> <div style="margin-bottom: 5px;">175</div> <div style="margin-bottom: 5px;">125</div> </div>	 <div style="display: flex; flex-direction: column; align-items: center;"> <div style="margin-bottom: 5px;">ST</div> <div style="margin-bottom: 5px;">150</div> <div style="margin-bottom: 5px;">225</div> </div>	 <div style="display: flex; flex-direction: column; align-items: center;"> <div style="margin-bottom: 5px;">ST</div> <div style="margin-bottom: 5px;">150</div> <div style="margin-bottom: 5px;">175</div> </div>
ALT-2	 <div style="display: flex; flex-direction: column; align-items: center;"> <div style="margin-bottom: 5px;">ST</div> <div style="margin-bottom: 5px;">125</div> <div style="margin-bottom: 5px;">210</div> <div style="margin-bottom: 5px;">225</div> </div>	 <div style="display: flex; flex-direction: column; align-items: center;"> <div style="margin-bottom: 5px;">ST</div> <div style="margin-bottom: 5px;">125</div> <div style="margin-bottom: 5px;">210</div> <div style="margin-bottom: 5px;">175</div> </div>	 <div style="display: flex; flex-direction: column; align-items: center;"> <div style="margin-bottom: 5px;">ST</div> <div style="margin-bottom: 5px;">125</div> <div style="margin-bottom: 5px;">210</div> <div style="margin-bottom: 5px;">150</div> </div>	 <div style="display: flex; flex-direction: column; align-items: center;"> <div style="margin-bottom: 5px;">ST</div> <div style="margin-bottom: 5px;">125</div> <div style="margin-bottom: 5px;">210</div> <div style="margin-bottom: 5px;">100</div> </div>	 <div style="display: flex; flex-direction: column; align-items: center;"> <div style="margin-bottom: 5px;">ST</div> <div style="margin-bottom: 5px;">125</div> <div style="margin-bottom: 5px;">210</div> </div>

MATERIAL DEFINITION

-  ST SURFACE TREATMENT
-  HAND CRUSHED BRICKS WITH 0 – 20% LOCAL SAND OR MIXTURE OF CRUSHED BOULDER, SHINGLES, PEA-GRAVELS & SAND (30:30:20:2)
-  SOIL STABILISED WITH 4% LIME
-  HAND CRUSHED BRICKS WITH 50% LOCAL SAND OR MIXTURE OF SYLHET SAND+ LOCAL SAND (40 : 60)
-  LOCAL FINE RIVER SAND / MECHANICALLY STAB. SAND CLAY MIXTURE / SANDY SILT WITH PI 5 - 8

PER SQM COST OF DIFFERENT TYPE OF PAVEMENT

(For Rangpur Road Circle taking rates of materials from RHD Schedule 1989)

(All cost in Taka)

RANGPUR

Traffic Level	Pavt. Type	Subgrade level				
		S1	S2	S3	S4	S5
T1	1	525	520	514	504	488
	2	524	519	513	508	491
	5	455	431	422	441	407
T2	1	564	558	550	540	522
	2	562	557	548	543	526
	5	472	463	447	466	430
T3	1	672	663	655	652	628
	2	672	664	651	648	631
	5	608	591	565	583	546
T4	1	918	877	866	829	811
	2	1,065	1,008	997	985	967
	3	1,247	1,201	1,175	1,141	1,126
	4	1,280	1,227	1,184	1,174	1,159
T5	1	953	915	904	852	832
	2	1,116	1,059	1,048	1,015	995
	3	1,326	1,283	1,230	1,223	1,208
	4	1,335	1,292	1,238	1,232	1,216