

$$\bar{x} = \frac{2 \times 5.88 + 1.5 \times 12.76}{(1.5 + 2 + 1.5)} = 6.18 \text{ m}$$

Now, $\frac{P_1 / 1.5A}{6.18} = \frac{P_2 / 2A}{0.3} = \frac{P_3 / 1.5A}{6.58}$ | $\therefore P_2 = 0.065 P_1$
 $P_3 = 1.0647 P_1$

Taking moment at O, $\sum M_O = 0$

$$12.2 \times 3.44 + P_2 \times 5.88 - P_3 \times 12.76 = 0$$

$\therefore P_1 = 31 \text{ kN}, \therefore P_2 = 2.05 \text{ kN}, P_3 = 33.79 \text{ kN}$

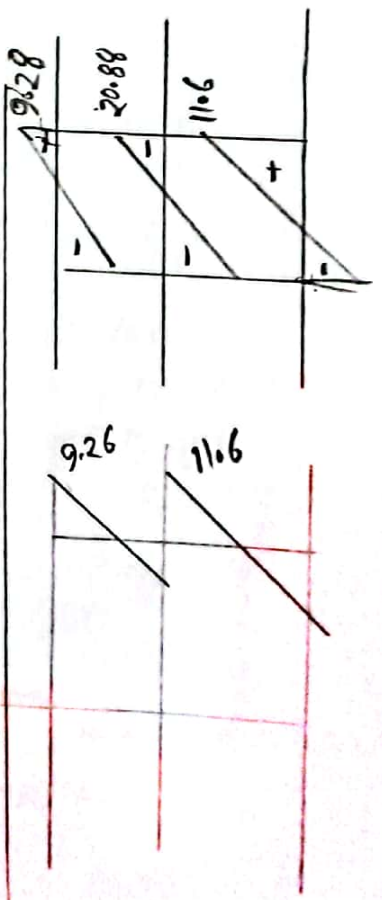
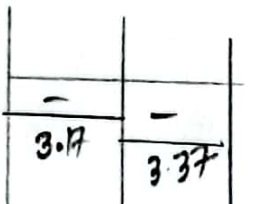
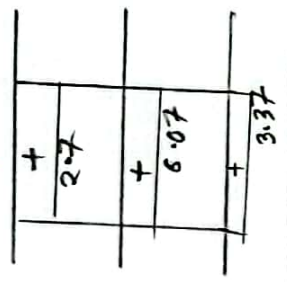
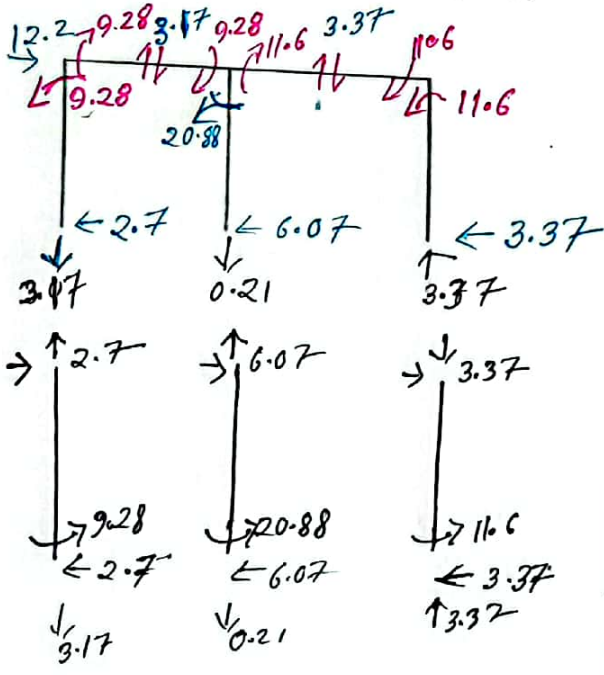

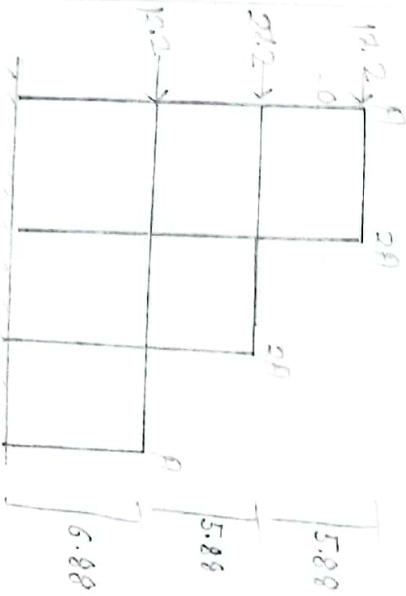

$$\sum M = 2A \times 5.88 - 3A = 3.92'$$

$$\frac{P_1/A}{3.92} = \frac{P_2/2A}{1.92}$$

$$\therefore P_1 = P_2 \quad \checkmark$$

$$\sum H_0 = 0$$

$$17.2 \times 29.4 - P_2 \times 5.88 = 0, \quad P_2 = 8.6k$$

$$\therefore P_1 = 8.6k$$

$$\sum M = \frac{2 \times 5.88 + 2 \times (5.88 + 6.88)}{5} = 7.46$$

$$\therefore \frac{P_1/A}{7.46} = \frac{P_2/2A}{1.58} = \frac{P_3/2A}{5.38}$$

$$\therefore P_2 = 0.92P_1, \quad P_3 = 1.94P_1$$

$$\sum H_0 = 0$$

$$27.2 \times 29.4 + 17.2(5.88 + 29.4) + P_2 \times 5.88 - P_3 \times 12.76 = 0$$

$$P_1 = 14.57, \quad P_2 = 7.9$$

$$P_3 = 25.3$$

$$\sum M = \frac{2 \times 5.88 + 2 \times (5.88 + 6.88) + 1(5.88 + 2 \times 6.88)}{9.48} = 9.48$$

$$\sum H_0 = 0$$

$$5 \times 5.69 + P_2 \times 5.88 - P_3 \times (5.88 + 6.88) = 0$$

$$P_4 (6.88 \times 2 + 5.88) = 6$$

$$\frac{P_1/A}{9.99} = \frac{P_2/2A}{5.61} = \frac{P_3/2A}{9.27} = \frac{P_4/A}{10.15}$$

$$\therefore P_2 = 0.76P_1, \quad P_3 = 0.69P_1, \quad P_4 = 1.07P_1$$

$$P_1 = 23.22, \quad P_2 = 17.6, \quad P_3 = 16.9, \quad P_4 = 24.9$$

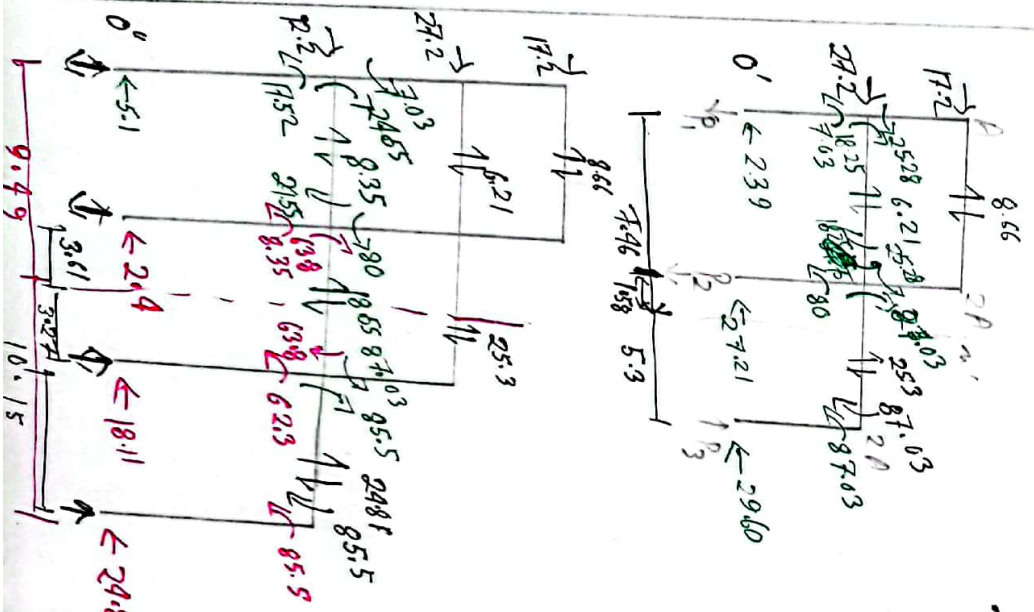

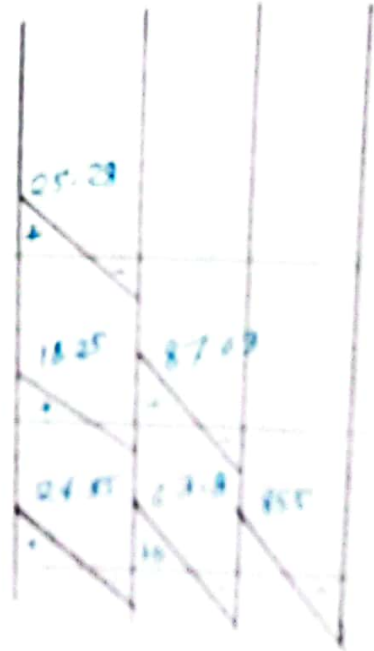
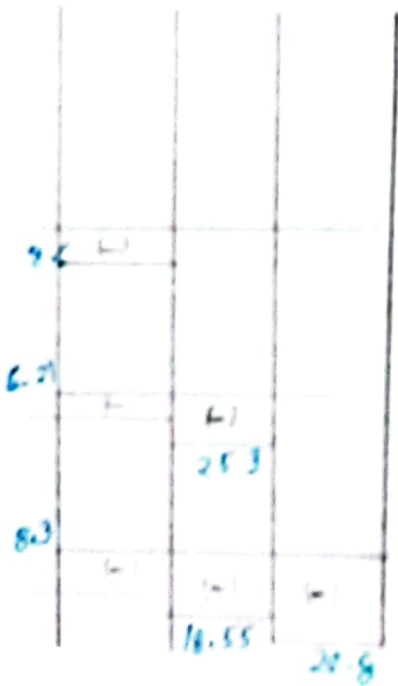
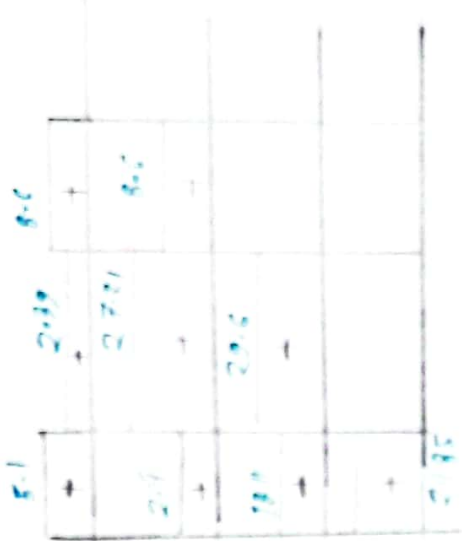

21

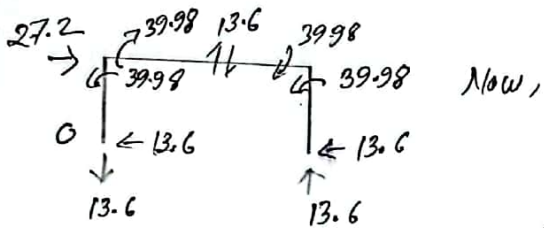
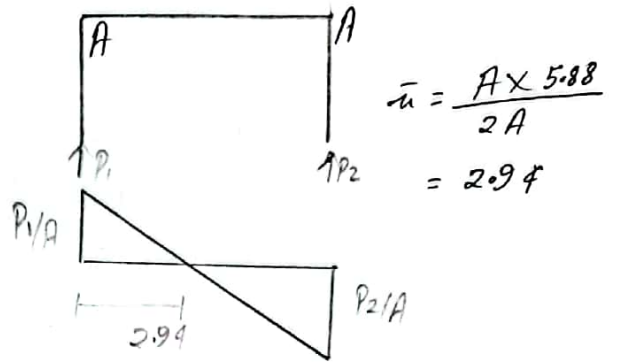
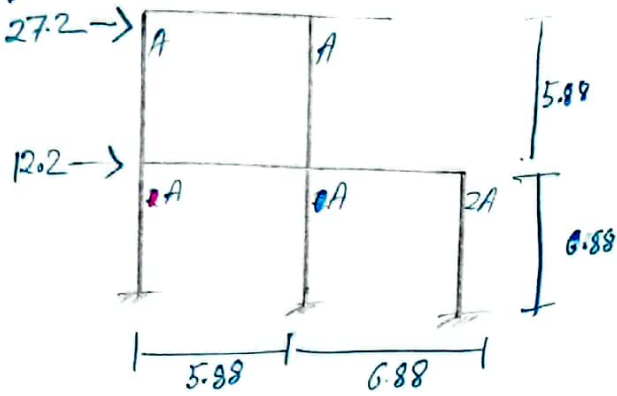

Now, $\frac{P_1/A}{2.94} = \frac{P_2/A}{2.94} \Rightarrow P_1 = P_2$

$\sum M_0 = 0, P_1 = P_2 = 13.6$

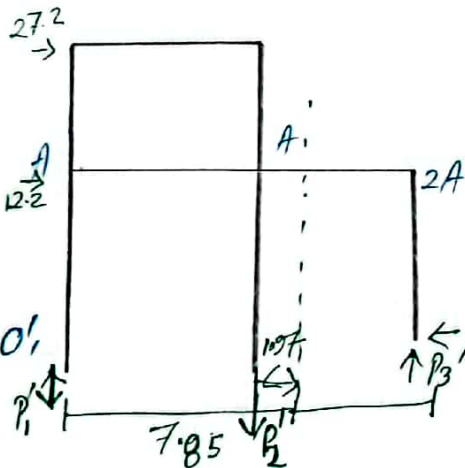

$\bar{x} = \frac{A \times 5.88 + 2A \times 12.76}{4A} = 7.85$

$\frac{P_1'/A}{7.85} = \frac{P_2'/A}{1.97} = \frac{P_3'/2A}{4.91}$

$P_2' = 0.25 P_1', P_3' = 1.25 P_1'$

$\sum M_0' = 0$

$-P_3 \times 12.76 + P_2 \times 5.88 + 12.2 \times 6.88 + 27.2 \times 12.76 = 0$

$\therefore P_1' = 29.76$

$P_2' = 7.44, P_3' = 37.2$

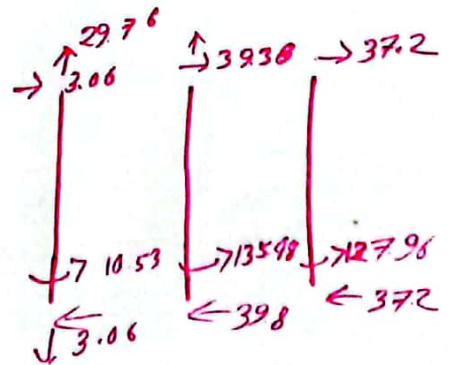
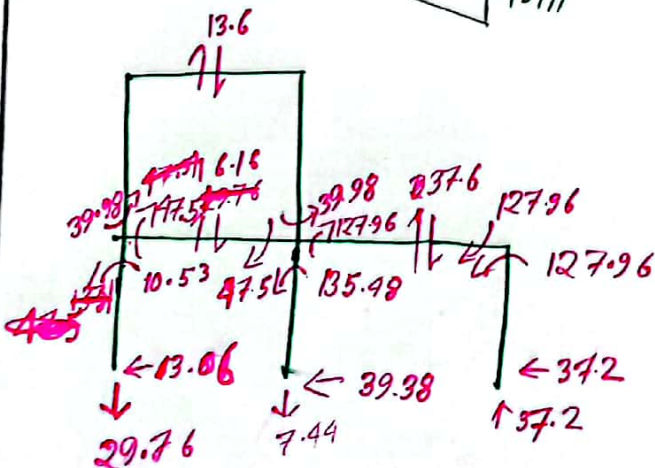

29.76			
+	13.6	+	
30.38		13.6	+
(+)			
37.12			
(+)			

10.53	39.98		
(-)	(-)	+	
	135.4		-
		(-)	127.96

(-)		
136		
(-)		
6.16		
	(-)	
	37.6	

	39.98	
47.5		
		127.96
		+

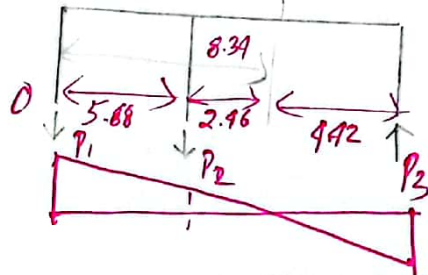
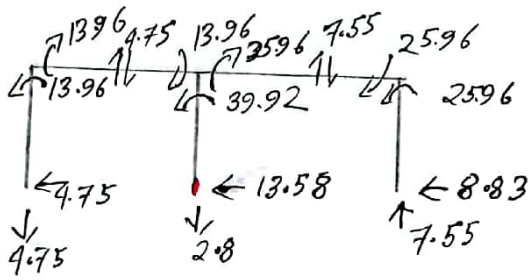
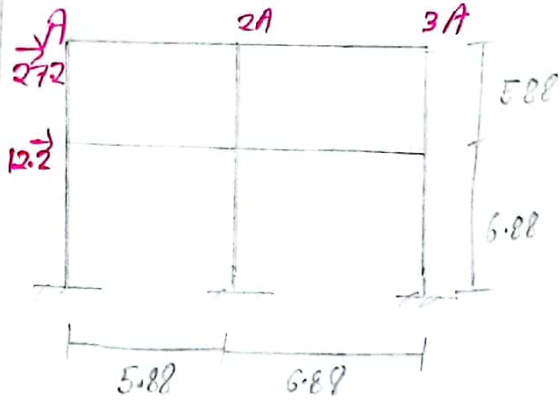

$$\bar{u} = 8.34 = \frac{27 \times 5.88 + 37 \times 12.76}{6A}$$

$$\frac{P_1/A}{8.34} = \frac{P_2/2A}{2.46} = \frac{P_3/3A}{4.42}$$

$$\therefore P_2 = 0.59 P_1 \quad P_3 = 1.59 P_1$$

$$\sum M_o = 0$$

$$27.2 \times 2.94 + P_2 \times 5.88 - P_3 \times 12.76 = 0$$

$$P_1 = 4.75, \quad P_2 = 2.8, \quad P_3 = 7.55$$

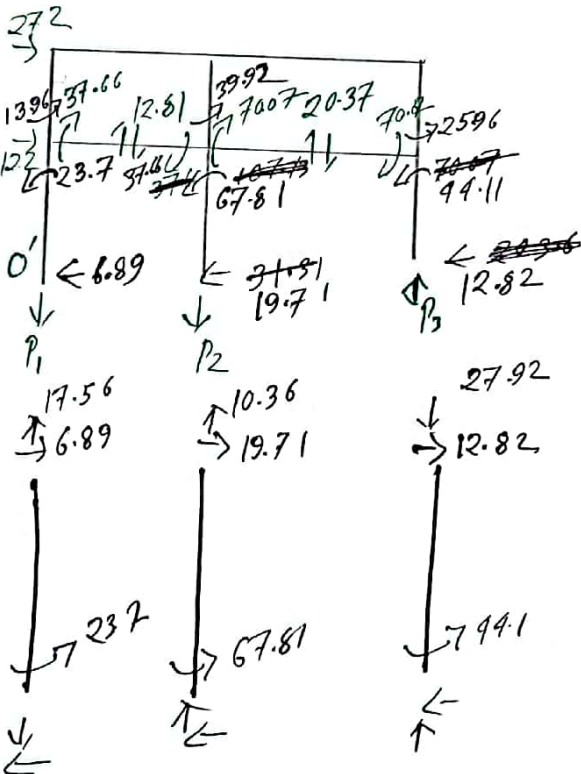

$$\bar{u} = 8.34 \text{ as previous}$$

$$\sum M_o = 0$$

$$27.2 \times 9.32 + 12.2 \times 3.44 + P_2 \times 5.88 - P_3 \times 12.76 = 0$$

$$P_1 = 17.56, \quad P_2 = 10.36, \quad P_3 = 27.92$$

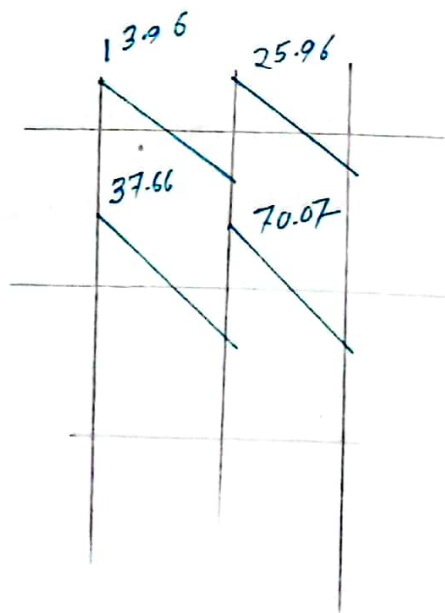
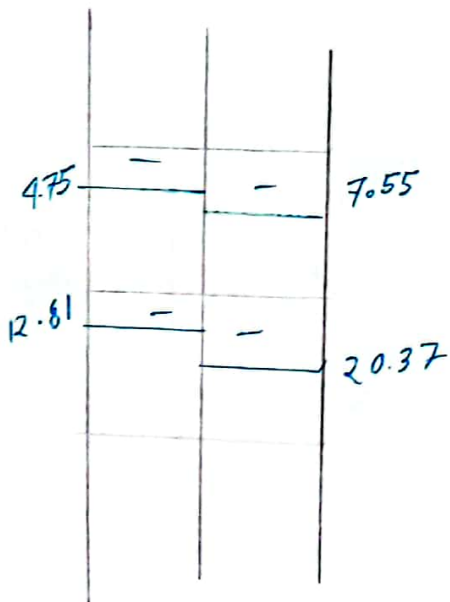
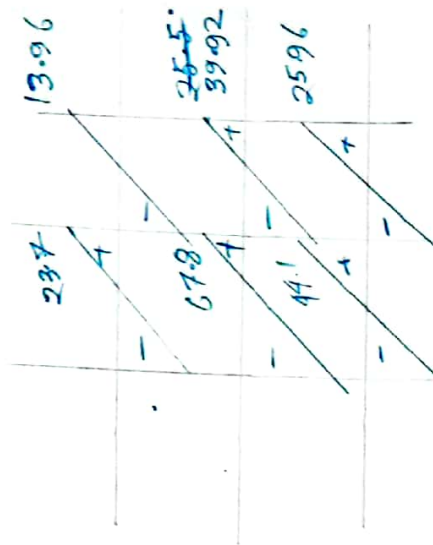
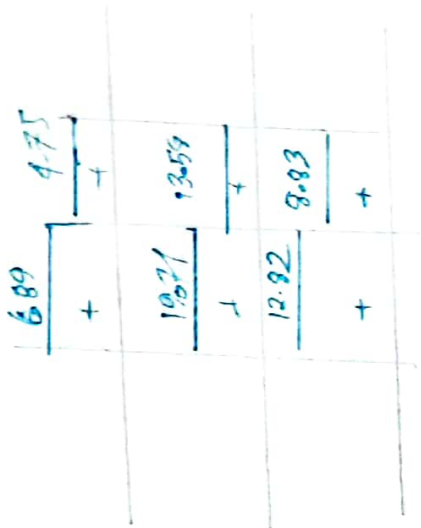

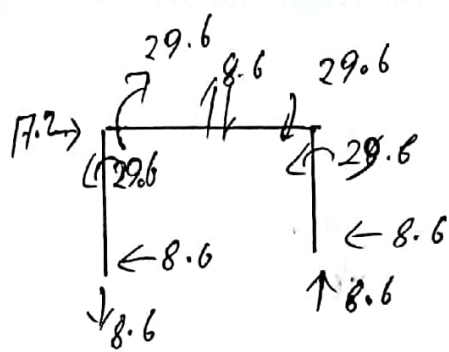
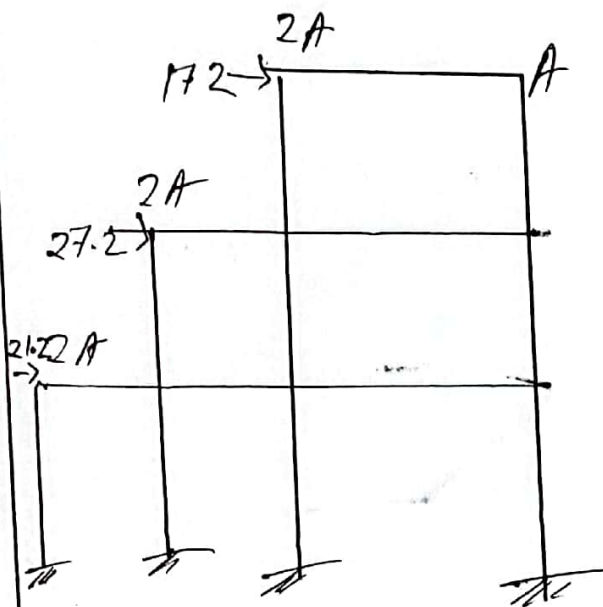

$$\bar{u} = 5.50$$

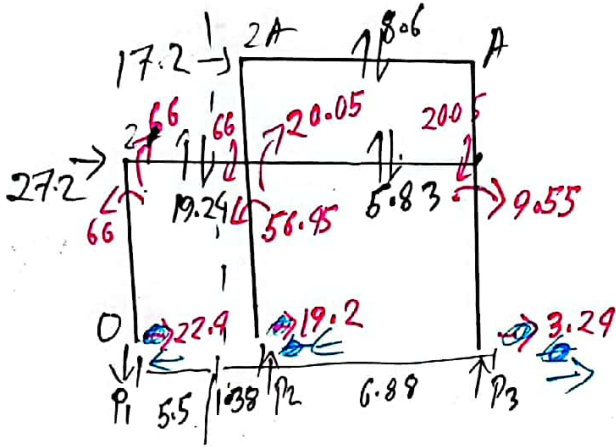

$$\frac{P_1/2A}{5.5} = \frac{P_2/2A}{1.38} = \frac{P_3/A}{8.26}$$

$$P_2 = 25P_1, \quad P_3 = 0.75P_1$$

$$\sum H_0 = 0$$

$$\therefore P_1 = 19.24, \quad P_2 = 482, \quad P_3 = 14.43$$

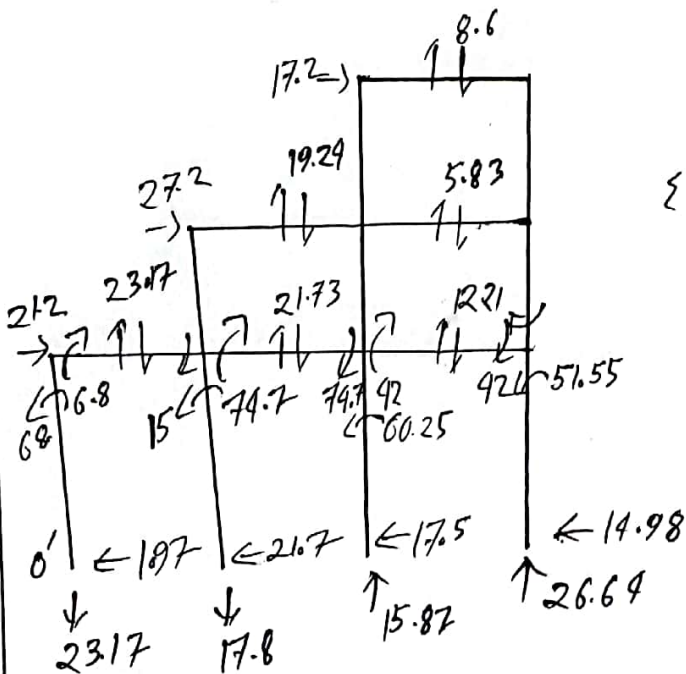

$$\bar{u} = 9.99$$

$$\sum H_0' = 0$$

$$P_1 = 23.17, \quad P_2 = 17.8$$

$$P_3 = 15.67, \quad P_4 = 26.64$$

1.97			
+			
21.7		22.4	
+		+	
17.05		19.2	8.6
+		+	
14.98			8.6
+			
			3.24

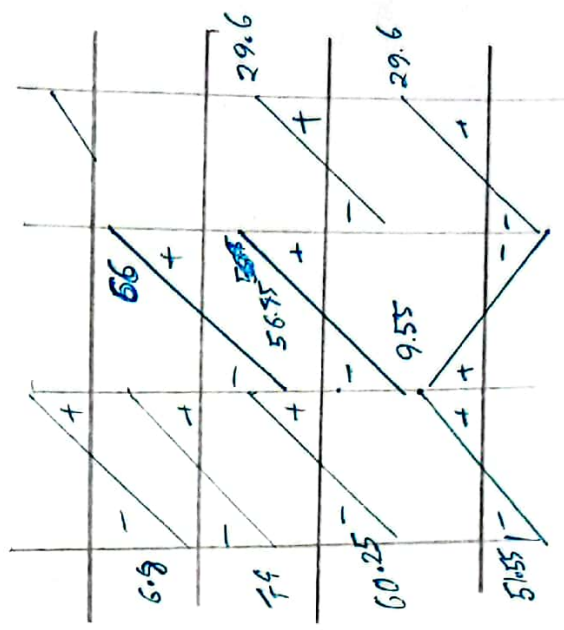

		8.6
		(-)
	19.24	
	(-)	5.83
	(-)	(-)
23.4	21.73	12.21
(-)	(-)	(-)

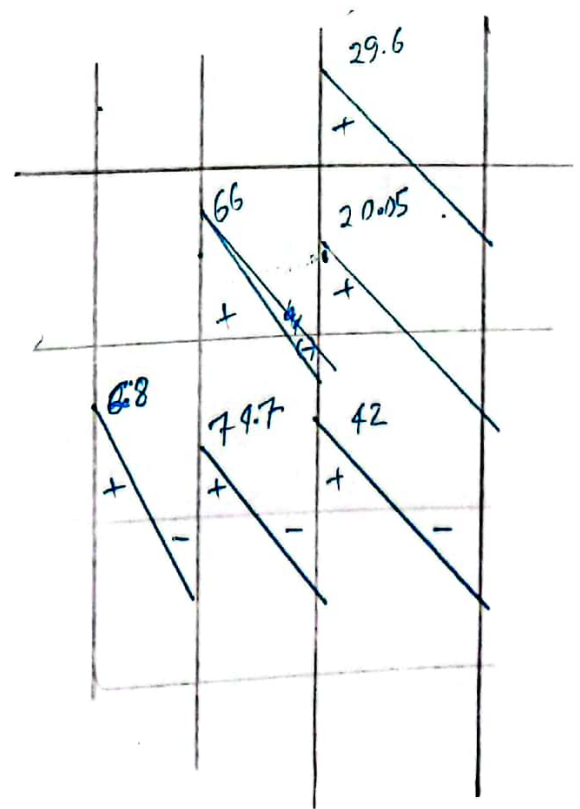

12.78, 19.61, 13.78

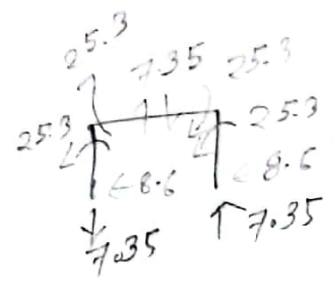
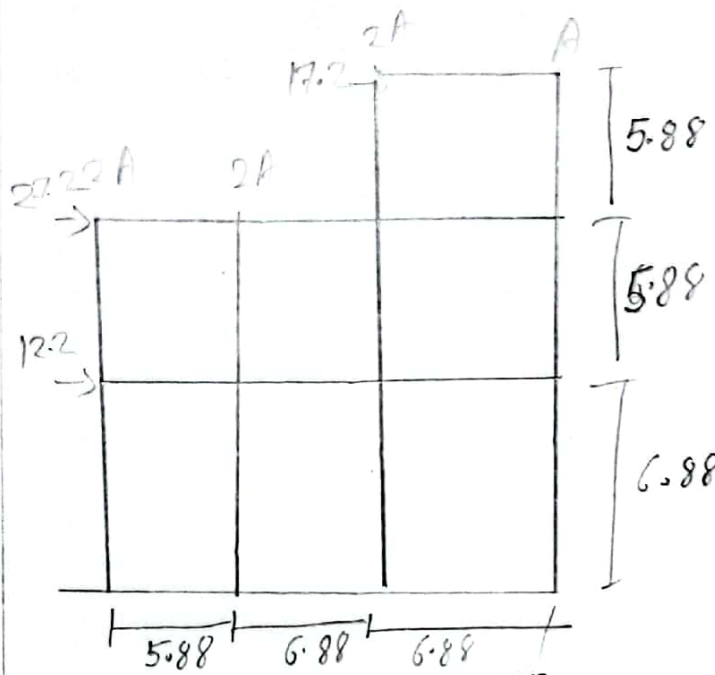

$$\bar{x} = 2 \times 5.88 + 2 \times 6.88 = 9.5$$

$$\frac{P_1/A}{9.5} = \frac{P_2/2A}{3.51} = \frac{P_3/2A}{3.22} = \frac{P_4}{10.15}$$

$$\Rightarrow P_2 = 0.76 P_1, P_3 = 0.69 P_1, P_4 = 1.07 P_1$$

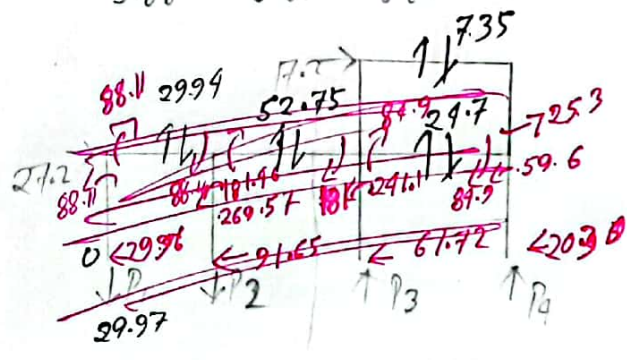

$$\sum M_0 = 0$$

$$27.2 \times 2.99 + 17.2 + (5.88 + 2 \times 9.5) \times 0.76 P_1 \times 5.88 - 0.69 P_1 \times 12.78 - 1.07 \times 19.61 P_1 = 0$$

$$P_1 = \frac{29.97}{9.13}, P_2 = \frac{22.78}{6.9}$$

$$P_3 = \frac{20.68}{6.3}, P_4 = \frac{32.1}{9.8}$$

$$\sum M_0' = 0$$

$$P_1 = 23, P_2 = 17.48,$$

$$P_3 = 15.87, P_4 = 24.61$$

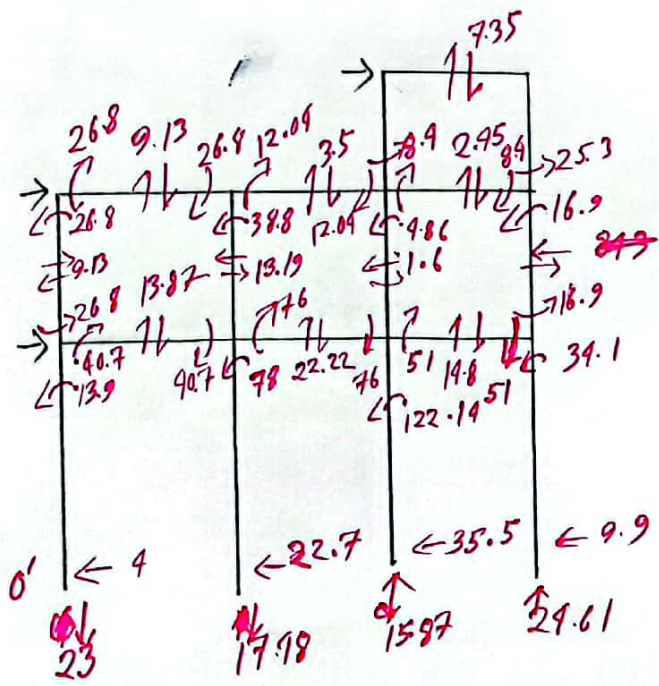

4	+	22.7	+	9.9	+	8.6
	+	35.5	+	1.6	+	8.6
	+	13.19	+	5.75	+	8.6
	+	9.13	+		+	

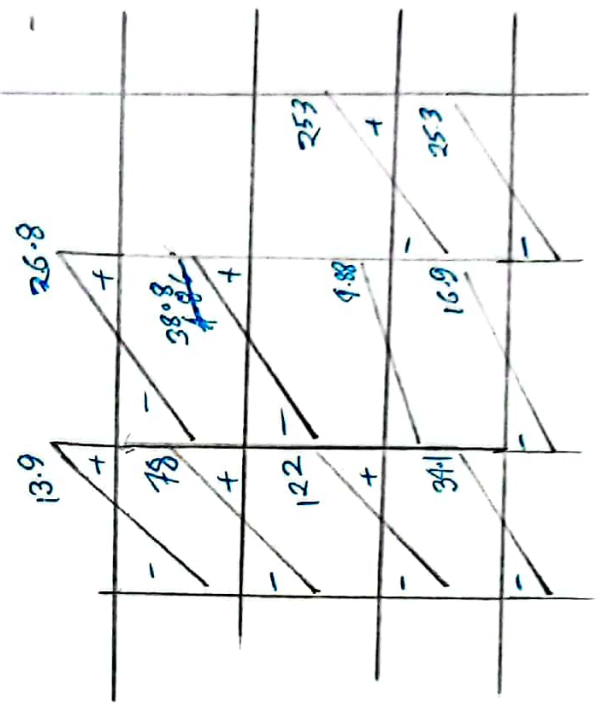

			7.35
			(-)
9.13			
	3.05		
(-)	(-)	2.45	
		(+)	
13.87	22.22	14.8	
(+)	(+)	(-)	

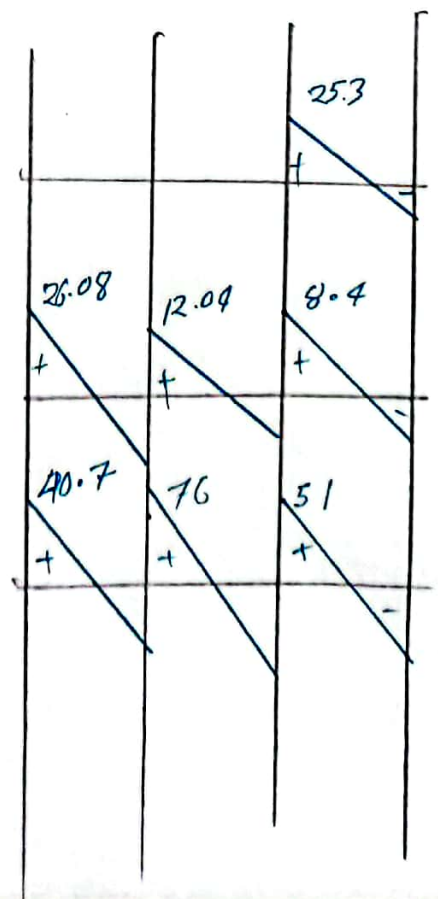

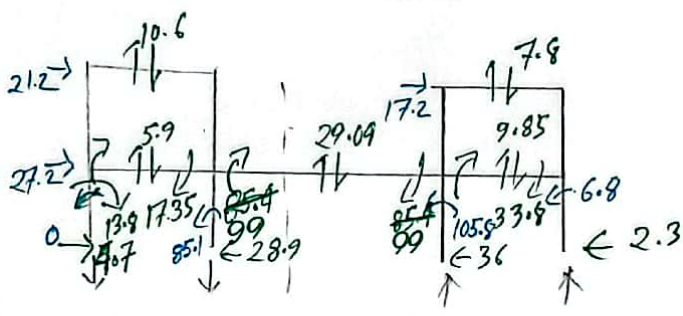
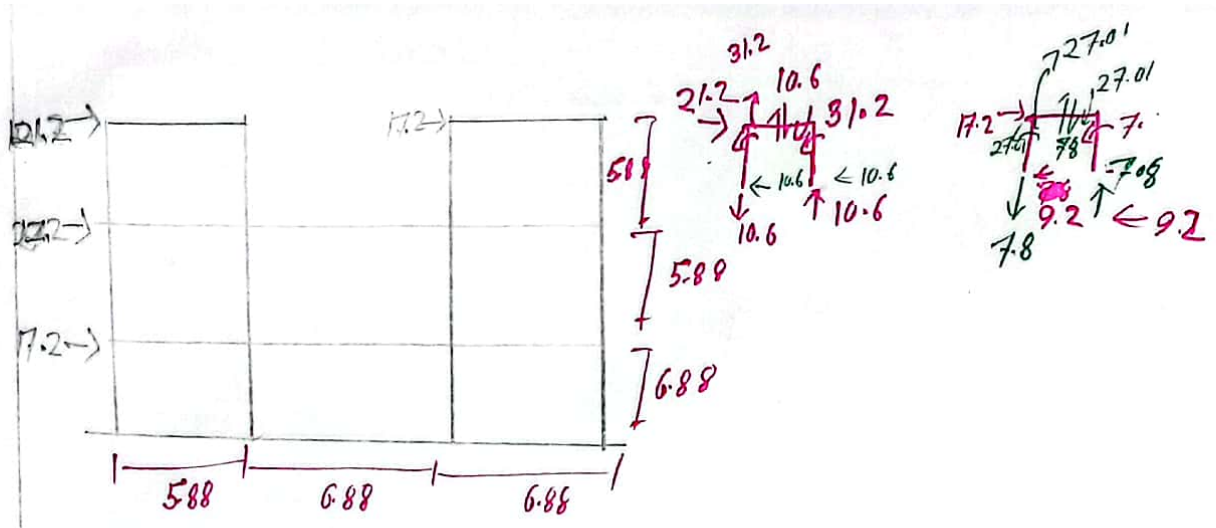

$$\bar{u} = 9.49$$

$$\sum M_0 = 0$$

$$(21.2 + 17.2) \times (5.88 + 2.99) + 27.2 \times 2.99$$

$$+ 0.76 P_1 \times 5.88 - 0.69 P_1 \times 12.78$$

$$- 1.07 \times 19.59 P_1 = 0$$

$$\therefore P_1 = 16.5, P_2 = 12.54, P_3 = 11.38$$

$$P_4 = 17.65$$

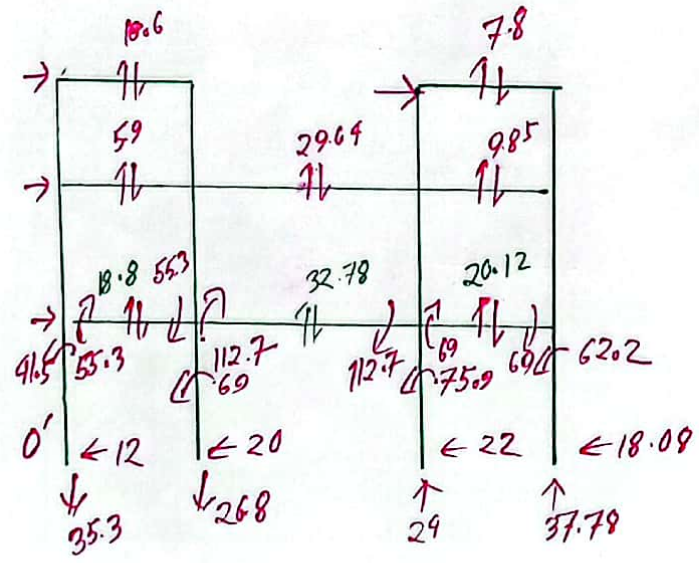

$$\sum M_0 = 0$$

$$\therefore P_1 = 35.3, P_2 = 26.8, P_3 = 29,$$

$$P_4 = 37.78$$

	+	188	(+)	59	+
	+	32.78	(+)	29.69	
	+	2012	(+)	9.85	+
					7.8

	+	12			+
	+	20		1.7	+
	+	22		28.9	+
	+		36		+
	+				9.2
	+	18.08			+
	+		2.3		9.2
	+				+

	+	55.3		71.35	+
	+	112.7		09	+
	+	69		33.8	+
					27.01
					31.2

	+	41.5		13.8	+
	+	60			+
	+	759		85.1	+
	+	622		105.8	+
	+				27.01
	+				27.01
	+				31.2
	+				31.2
	+				27.01
	+				27.01
	+				6.8